

# MANGUERAS INDUSTRIALES EN CAUCHO Y PVC

INDUSTRIAL RUBBER AND PVC HOSES





# CONNECT.SUPPORT.CONVEY

Desde hace casi 60 años, Sati Group produce y distribuye bandas transportadoras en caucho, mangueras industriales en caucho y PVC, planchas y tapetes en caucho.

Since 60 years, Sati Group produces and distributes rubber conveyor belts, industrial rubber and PVC hoses, rubber sheeting and foam rubber.

Siempre hemos apostado por un servicio fiable, entregas puntuales, disponibilidad permanente de más de 5.000 artículos almacenados de alta calidad y además por un servicio personalizado y puntual que nos permite gestionar más de 2.500 pedidos al mes. Casi sesenta años de historia no se improvisan. En un entorno internacional cada vez más competitivo, la gran experiencia acumulada durante décadas de éxito en los principales mercados internacionales, nos ha enseñado la importancia de escuchar a los clientes para anticiparnos a sus necesidades y responder con eficacia incluso en las situaciones más complicadas. La búsqueda de nuevas soluciones forma parte de nuestro ADN.

Siempre hemos seguido buscando por todo el mundo productos de calidad superior para mejorar el rendimiento y la eficacia de todo tipo de procesos industriales. Vamos invirtiendo en desarrollo, diseño y fabricación de soluciones y productos innovadores, como nuestras líneas de producción SATIVERTICAL (bandas transportadoras de bordes y cangilones) y SATIFOAM (materiales de espuma), que marcan la diferencia en rendimiento y durabilidad.

Nuestra sede de Castel Maggiore ocupa una superficie de más de 20.000 metros cuadrados y está dotada de los equipos más avanzados para la producción, el montaje y la manipulación de todos los artículos del catálogo. Nuestro objetivo es garantizar la máxima eficacia de producción y eficiencia logística para el cliente, respetando al mismo tiempo la seguridad y el bienestar de todo nuestro equipo.

We based our service on the reliability, rapid deliveries, the availability of over 5000 high quality products in our warehouse and the tailor made service that allow us to handle over 2500 orders every month. Almost sixty years of history have taught us the importance of listening to our customers in order to understand their needs and to provide support in handling complex procedures and special orders. The searching of new solutions is in our DNA.

We try to find all over the world high quality products in order to increase the efficiency of every industrial process. We invest in development and we realize innovative solutions and products such as our SATIVERTICAL (sidewalls and cleats belts) and SATIFOAM (foam materials) production lines.

Our headquarter based in Castel Maggiore occupies an area of over 20.000 square meters and it is equipped with the most advanced production, assembly and handling systems. Our goal is to ensure the best logistic and production efficiency for our customers in full respect for the welfare of our team.





Nuestra fuerza también reside en nuestra sede, que nos permite mantener: 20.000 m<sup>2</sup> de almacén y más de 500 m<sup>2</sup> de oficinas, que nos permiten tener más de 5.000 artículos en stock y, gracias a ello, atender puntualmente más de 2.400 pedidos de clientes al mes.

Our strength also lies in our main base, where we have 20,000 sqm of warehouse and 500 sqm of office space, enabling us to offer more than 5,000 items ready for delivery and therefore to efficiently handle over 2,400 orders every month.





La logística que funciona.  
Logistics that work.

# INDICE

## INDEX



### MANGUERAS PARA AGUA Y FLUIDOS INERTES

#### WATER AND INERT FLUID HOSES

7

●	ACQUA / LN 10	8
●	PRESSCORD 10 BAR	9
●	ACQUA / HD 10	10
●	POMPE ACQUA / 10	11
●	POMPE ACQUA / 20	12
●	CORDFLAT L LIGERA / LIGHT	13
●	CORDFLAT M MEDIA / MEDIUM	14
●	CORDFLAT P PESADA / HEAVY	15
●	CORDFLAT I INDUSTRIAL	16
●	ACQUA / SP 10	17
●	ONDULATO / SPM	18
●	CORDFLEX S.T. LÍQUIDOS	19
●	AGRISTEEL PL	20
●	CORDFLEX PESADO / HEAVY	21
●	CORDFLEX S.E. LÍQUIDOS	22
●	CORDFLEX SUPERIOR S.E.	23
●	CORDFLEX IDROS	24
●	WATER POWER HD 250 BAR	25
●	FIRE HD 40 BAR	26



### MANGUERAS TRENZADAS PARA FUMIGACIÓN Y JARDINERÍA

#### BRAIDED SPRAYING AND GARDENING PVC HOSES

27

●	FRUTCORD 25 BAR	28
●	FRUTCORD 40 BAR PREMIUM	29
●	FRUTCORD 40 BAR	30
●	FRUTCORD 50 BAR	31
●	FRUTCORD 80 BAR	32
●	FRUTCORD 100 BAR	33
●	ELBACORD NO TWIST	34
●	NEMOCORD NO TWIST	35
●	GARDENCORD VG	36



### MANGUERAS PARA AIRE COMPRIMIDO

#### COMPRESSED AIR HOSES

37

●	ARIA / LN 20	38
●	PRESSCORD 20 BAR	39
●	PRESSCORD PU	40
●	PRESSCORD SUPER	41
●	ARIA / HD 20	42
●	ARIA / HD 25	43
●	ARIA / SHD 40	44



### MANGUERAS PARA ACEITES, ÓLEO Y CARBURANTES

#### OIL AND FUEL HOSES

45

●	CRISTALBENZ	46
●	CARBO / LN 10	47
●	CARBO / LN 20	48
●	CARBO / LN 25	49
●	CARBO / ECO	50
●	CARBO / ISO 7840 A1	51
●	CARBO / LN DIN 73379	52
●	POWERBLUE / LN ISO 22241	53
●	CARBO / LN SAE J30 R7	54
●	CARBO / LN SAE J30 R2-R6	55
●	EASY LOCK / LN SAE 100 R6	56
●	CARBO / HD 10	57
●	ASPOCORD / HD 20	58
●	CARBO STATION	59
●	CARBO / SP 10	60
●	CORDFLEX OIL S.E.	61
●	CORDFLEX OIL ANTISTATIC	62
●	GRECATO / SP MULTIPURPOSE	63
●	ONDULCARBO / SPR	64
●	ONDULCARBO / SPM	65
●	TANK TRUCK / HD EN 12115	66
●	TANK TRUCK / SP EN 12115	67
●	SAE 100 R4	68
●	OIL / RETURN	69
●	SAE 100 R6	70
●	SAE 100 R3	71
●	DIN 20021 2 TE	72
●	DIN 20021 3 TE	73
●	SAE J 1401	74
●	SAE 100 R7	75



### VAINAS Y ESPIRALES DE PROTECCIÓN

#### SPIRAL PROTECTION PVC HOSES

76

●	MOLLAFLEX SMART	77
●	MOLLAFLEX HD	78
●	HELIMOPLEN	79
●	PROTECH / PP	80
●	PROTECH / PA	81
●	PROTECH / SIL	82
●	PROTECH / HD	83
●	VIBRO 10	84





## MANGUERAS TRENZADAS DE ACERO TEXTILE AND STEEL WIRE HOSES

### 85

●	SAE 100 R6 ZINC	86
●	SAE 100 R4 ZINC	87
●	CARBO / LN 10 ZINC	88
●	CARBO / HD 10 ZINC	89
●	EN 857 1SC ZINC	90
●	EN 857 2SC ZINC	91
●	DIN 20021 2TE ZINC	92
●	NBR ZINC	93
●	EPDM ZINC	94
●	PTFE INOX	95
●	PTFE OND INOX	96
●	TREC OIL CARBO ECO / TT	97



## MANGUERAS PARA AGUA CALIENTE Y VAPOR HOT WATER AND STEAM HOSES

### 98

●	EPDM / LN 10	99
●	EPDM / LN 20 MULTIPURPOSE	100
●	EPDM / ES	101
●	EASY LOCK / LN 135°	102
●	RADIATOR	103
●	GRECATO / SP MULTIPURPOSE	104
●	ACQUA CALDA / 120°C	105
●	VAPOR / 160°C	106
●	WATER INTAKE / SP	107
●	VAPORE ARMATO	108



## MANGUERAS PARA EL SUMINISTRO DE PRODUCTOS ALIMENTICIOS FOOD DELIVERY HOSES

### 109

●	EPDM FQ	110
●	PRESSCORD FQ	111
●	CLEANING LB	112
●	CLEANING / HD	113
●	CRISTALCORD PARA ALIMENTOS/ FOR FOOD	114
●	CRISTALLO ALIMENTARE	115
●	CRISTALSIL FDA	116
●	CORDSTEEL S.E. PASO ESTRECHO / SHORT PITCH	117
●	CORDSTEEL P.L. PASO ANCHO / LARGE PITCH	118
●	MULTISTEEL FG	119
●	CORDFLEX L.D. PARA ALIMENTOS / FOR FOOD	120
●	CORDFLEX N.T. PARA ALIMENTOS / FOR FOOD	121
●	CORDFLEX H.D. PARA ALIMENTOS / FOR FOOD	122
●	CORDFLEX H.D. PARA ALIMENTOS / FOR FOOD ANTIESTÁTICO / ANTISTATIC	123
●	MULTIFLEX FG	124



ULTRAFOOD SP

125



WHITE ALIMENT / HD

126



WHITE ALIMENT / SP

127



FAT ALIMENT / HD

128



FAT ALIMENT / SP

129



VINOREX

130



## MANGUERAS CON ESPIRAL PARA ASPIRACIÓN DE AIRE, VENTILACIÓN Y AIRE ACONDICIONADO

### 131

VACUUM AND CONDITIONING SPIRAL  
PVC HOSES



CORDFLEX AIR

132



CORDFLEX AIR / P

133



THERMOCORD HL

134



THERMOCORD 130°C

135



THERMOCORD TPR

136



THERMOCORD NEOPRENE 150°C - 1S

137



THERMOCORD NEOPRENE 150°C - 2S

138



THERMOCORD SILICONE 300°C - 1S

139



THERMOCORD SILICONE 300°C - 2S

140



ARTIC / ESP

141



## MANGUERAS PARA MATERIALES ABRASIVOS BULK MATERIAL HOSES

### 142



CORDFLEX AIR PU

143



CORDFLEX AIR PU ANTIESTÁTICO / ANTISTATIC

144



AEROCORD PU / ECO

145



AEROCORD PU

146



AEROCORD PU-H

147



SABBIA / HD 12

148



SABBIA / HD 18

149



ABRABETON / 12

150



ABRABETON / 40

151



CORDFLEX PU LÍQUIDOS

152



CORDFLEX PU PESADO / HEAVY

153



CEMENTO / HD

154



CEMENTO / SP

155



ABRAELASTIC / SP

156



ABRABETON UC 85

157



ASPHALT / SP

158



STREET SWEEPER

159



SILO / HD

160



SILO / SP

161



ASPIRDUST / SP

162



FLOSTER PARA / HD

163



FLOSTER EPDM / HD

162



## MANGUERAS PARA GAS Y SOLDADURA

165

GAS AND WELDING HOSES

●	OSSIGENO / LB ISO 3821	166
●	ACETILENE / LR ISO 3821	167
●	BINATO / LB+LR ISO 3821	168
●	PROPANO / LA ISO 3821	169
●	GPL / HD	170
●	GPL / SP	171
●	GAS AUTO	172
●	ARGON / LN ISO 3821	173
●	PRESSCORD METANO UNI CIG	174
●	PRESSCORD GPL UNI CIG	175



## MANGUERAS PARA ACERERÍAS

176

STEEL MILL HOSES

●	ACQUA HD 40 AUTOEXTINGUIBLE / SELF-EXTINGUISHING	177
●	CFV HD 10 / 20 EPDM BLANCO / WHITE EPDM	178
●	CFV SP 10 / 20 SBR NEGRO / BLACK SBR	179
●	CFV HD 40 AUTOEXTINGUIBLE / SELF-EXTINGUISHING	180



## MANGUERAS PARA EL PASO DE PRODUCTOS QUÍMICOS

181

CHEMICAL DELIVERY HOSES

●	CHIMICO / HD	182
●	CHIMICO / SP	183
●	VERNICI / SP	184
●	CORDLINKED / HD	185
●	CORDLINKED / SP	186
●	CHIMICO / HD EN 12115	187
●	CHIMICO / SP EN 12115	188
●	CORDLINKED / SP EN 12115	189



## MANGUERAS INDUSTRIALES PARA USO NAVAL Y EMBARCACIONES DE PUERTO

190

MARINE INDUSTRIAL HOSES

●	CARBOMARINE / LN 10	191
●	CARBOMARINE / SP	192
●	CARBOMARINE / SP-C	193
●	CARBOMARINE / IT	194
●	MARINGAS / SP	195
●	SILMARINE / SP	196
●	SANITARI / WC ULTRAFLEX	197
●	CORDSTEEL / WC	198
●	SANIFLEX / WC	199
●	SANISTEEL / WC	200
●	ARTIC THERM	201
●	ARTIC ESP	202



## SATIBLOCK®

ABRAZADERAS Y COLLARES DE APRIETE

203

CLAMPS AND COLLARS

●	STF W1	204
●	STF W2	205
●	STF W4	206
●	STF W5	207
●	STC W2	208
●	STC W4	209
●	STC W5	210
●	MAGNUM W2	211
●	MAGNUM W4	212
●	STM	213
●	STS	214
●	SDB	215
●	SGT	216
●	SBS	217
●	SBV	218
●	SSS	219
●	DIN 3016 W1	220
●	BANDI BLOCK	221

## SÍMBOLOS / SYMBOLS



DIÁMETRO INTERIOR  
INSIDE DIAMETER



DIÁMETRO EXTERIOR  
OUTSIDE DIAMETER



SESPEOR DE LA PARED  
WALL THICKNESS



PRESIÓN DE EJERCICIO  
WORKING PRESSURE



PRESIÓN DE ROTURA  
BURST PRESSURE



ASPIRACIÓN  
VACUUM



PESO  
WEIGHT



RADIO DE CURVATURA  
BENDING RADIUS



LONGITUD  
LENGHT



TEMPERATURA DE EJERCICIO  
WORKING TEMPERATURE

RUBBER

MANGUERAS INDUSTRIALES  
DE CAUCHO  
INDUSTRIAL RUBBER HOSES

PVC

MANGUERAS FLEXIBLES DE PVC  
FLEXIBLE PVC HOSES



SATIBLOCK®  
ABRAZADERAS Y COLLARES DE APRIETE  
CLAMPS AND COLLARS

OTROS DIÁMETROS O PRESIONES DISPONIBLES  
BAJO PEDIDO.  
Las características y los datos técnicos  
están sujetos a cambios sin previo aviso.

OTHER DIAMETERS AND/OR PRESSURES ARE  
FEASIBLE UPON REQUEST.  
The characteristics and technical data  
could be changed without warning.



# MANGUERAS PARA AGUA Y FLUIDOS INERTES

WATER AND INERT  
FLUID HOSES





## RUBBER



### USO APPLICATIONS

Para la entrega de agua, aire y fluidos inertes cuando se requiere ligereza y flexibilidad. Se utiliza en muchas aplicaciones agrícolas e industriales. Sigue siendo muy flexible incluso en invierno.

For water, air and inert fluids delivery where it is necessary lightness and flexibility. Useful to agriculture and industrial sector. This hose is very flexible also during the winter season.



### ESTRUCTURA BODY

<b>A</b>	<b>Capa interior Tube</b>	Lisa en caucho SBR de color negro. Natural and synthetic black rubber.
<b>B</b>	<b>Refuerzos Reinforcement</b>	Textiles sintéticos. High tensile synthetic textile.
<b>C</b>	<b>Capa exterior Cover</b>	Lisa en caucho SBR de color negro resistente a la abrasión y a los agentes atmosféricos. Weather and abrasion resistant smooth synthetic rubber.
	<b>Superficie Surface</b>	Lisa. Smooth.



### ABRAZADERAS Y COLLARES DE APRIETE RECOMENDADOS RECOMMENDED CLAMP/COLLAR

STF - Abrazaderas de tornillo Hose clamps with screw (pag. 204-207)  
STC - Abrazaderas con perno Hose clamps with bolt (pag. 208-210)



mm	mm	bar	bar	bar	gr/mt	mm	m
5	10,5	10	30	-	92	50	100
8	15	10	30	-	173	80	100
10	16	10	30	-	190	100	100
10	17	10	30	-	204	100	100
12	18	10	30	-	186	120	100
13	19	10	30	-	210	130	100
15	21	10	30	-	236	150	50
16	23	10	30	-	297	160	50
19	26	10	30	-	344	190	50
20	30	10	30	-	540	200	50
22	30	10	30	-	460	220	50
25	33	10	30	-	530	250	50
25	35	10	30	-	700	250	50



**NORMAS** NORMS  
ISO 1307  
**MARCADOR** MARKING  
EUROCORD® WATER RUBBER HOSE P.E. 10 BAR  
ISO 1307  
**EMBALAJE** BOX  
EMBALAJE EN POLIETILENO NEGRO  
PACKAGING IN BLACK POLYETHYLENE



**-25°C / +70°C**  
**-13°F / +158°F**





PVC



**USO  
APPLICATIONS**

Para la entrega de agua, aire y fluidos inertes cuando se requiere ligereza y flexibilidad. Se utiliza en muchas aplicaciones agrícolas e industriales.

For water, air and inert fluids delivery where it is necessary lightness and flexibility. Useful to agriculture and industrial sector.



**ESTRUCTURA  
BODY**

<b>A</b>	<b>Capa interior</b> Tube	Lisa en PVC de color negro. Special synthetic PVC compound.
<b>B</b>	<b>Refuerzos</b> Reinforcement	Textiles sintéticos. High tensile synthetic textile.
<b>C</b>	<b>Capa exterior</b> Cover	Lisa en PVC de color negro, resistente a la abrasión y a los agentes atmosféricos. Abrasion and weather resistant special PVC compound.
	<b>Superficie</b> Surface	Lisa. Smooth.

mm	mm	bar	bar	bar	gr/mt	mm	m
8	15	10	30	-	191	-	100
10	17	10	30	-	224	-	100
12	17	10	30	-	171	-	100
13	19	10	30	-	225	-	100
15	21	10	30	-	254	-	50
16	23	10	30	-	321	-	50
19	26	10	30	-	372	-	50
20	30	10	30	-	550	-	50
22	30	10	30	-	465	-	50
25	33	10	30	-	510	-	50
25	35	10	30	-	650	-	50
25	33	10	30	-	530	250	50
25	35	10	30	-	700	250	50



**ABRAZADERAS Y COLLARES DE APRIETE  
RECOMENDADOS  
RECOMMENDED CLAMP/COLLAR**

STF - Abrazaderas de tornillo Hose clamps with screw (pag. 204-207)

SGT - Abrazaderas pinzables Stepp less (pag. 216)



**NORMAS** NORMS:  
ISO 1307  
**MARCADOR** MARKING:  
PRESSCORD® WATER HOSE WP 10BAR 16.05



**-10°C / +60°C**  
**+14°F / +140°F**

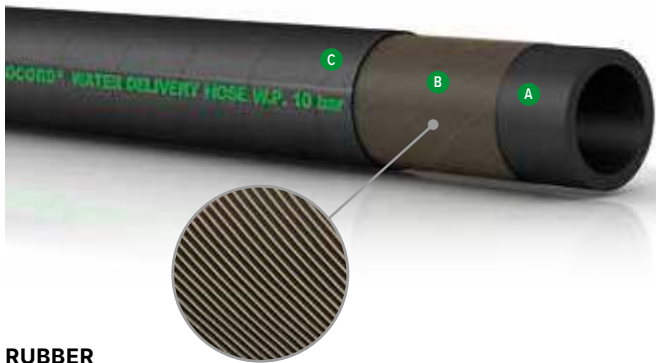

**RUBBER**



**USO APPLICATIONS**

Para la entrega de agua, aire y fluidos inertes cuando se requiere ligereza y flexibilidad. Se utiliza en muchas aplicaciones agrícolas e industriales. Sigue siendo muy flexible incluso en invierno.

For water, air and inert fluids delivery where it is necessary lightness and flexibility. Useful to agriculture and industrial sector. This hose is very flexible also during the winter season.



**ESTRUCTURA BODY**









<b>A</b>	<b>Capa interior Tube</b>	Lisa en caucho SBR de color negro. Natural and synthetic black rubber.
<b>B</b>	<b>Refuerzos Reinforcement</b>	Textiles sintéticos. High tensile synthetic textile.
<b>C</b>	<b>Capa exterior Cover</b>	Lisa en caucho SBR de color negro resistente a la abrasión y a los agentes atmosféricos. Weather and abrasion resistant smooth synthetic rubber.
	<b>Superficie Surface</b>	Lisa con impresión de tela. Smooth with fabric impression.



**ABRAZADERAS Y COLLARES DE APRIETE RECOMENDADOS RECOMMENDED CLAMP/COLLAR**

STF - Abrazaderas de tornillo Hose clamps with screw (pag. 204-207)  
 STC - Abrazaderas con perno Hose clamps with bolt (pag. 208-210)



 mm	 mm	 bar	 bar	 bar	 gr/mt	 mm	 m
25	34	10	30	-	546	254	40
30	42	10	30	-	958	300	40
32	44	10	30	-	1002	320	40
35	48	10	30	-	1207	350	40
38	52	10	30	-	1395	380	40
40	54	10	30	-	1484	400	40
45	61	10	30	-	1528	450	40
50	64	10	30	-	1639	500	40
60	78	10	30	-	3579	600	40
80	103	10	30	-	4558	800	20-40
100	126	10	30	-	6225	1000	20-40



**NORMAS NORMS:**  
 ISO 1307  
**MARCADOR MARKING:**  
 EUROCORD® WATER DELIVERY HOSE W.P. 10 BAR  
**EMBALAJE BOX:**  
 EMBALAJEEN POLIETILENO NEGRO  
 PACKAGING IN BLACK POLYETHYLENE



**-25°C / +70°C**  
**-13°F / +158°F**



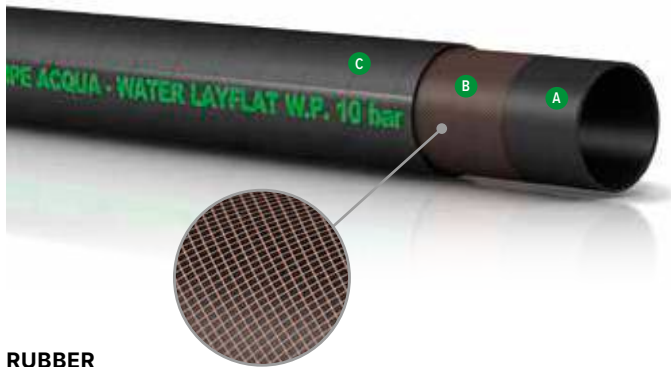

**RUBBER**

- Manguera plana.**  
**Flattenable.**

**USO APPLICATIONS**

Para entrega y descarga de agua y fluidos no corrosivos. Normalmente se utiliza para acompañar bombas sumergibles o la conducción de agua en drenajes de aguas subterráneas. Se puede aplanar y enrollar en bobinas.

For water and non corrosive fluids delivery. Used in support to submersible pumps or to conveying water in groundwater. It could be flattened or wrapped.



**ESTRUCTURA BODY**

<b>A</b>	<b>Capa interior Tube</b>	Lisa en caucho SBR de color negro. Natural and synthetic black rubber.
<b>B</b>	<b>Refuerzos Reinforcement</b>	Textiles sintéticos. High tensile synthetic textile.
<b>C</b>	<b>Capa exterior Cover</b>	Lisa en caucho SBR/EPDM de color negro resistente a la abrasión y a los agentes atmosféricos. Weather and abrasion resistant smooth synthetic rubber.
	<b>Superficie Surface</b>	Lisa con impresión de tela. Smooth with fabric impression.

25	31	10	30	-	338	-	40
30	36	10	30	-	411	-	40
40	46	10	30	-	558	-	40
45	51	10	30	-	663	-	40
50	57	10	30	-	751	-	40
60	67	10	30	-	990	-	40
70	77	10	30	-	1081	-	40
75	85	10	30	-	1173	-	40
80	87	10	30	-	1308	-	20-40
90	97	10	30	-	1464	-	20-40
100	108	10	30	-	1660	-	20-40

**ABRAZADERAS Y COLLARES DE APRIETE RECOMENDADOS RECOMMENDED CLAMP/COLLAR**

STC - Abrazaderas con perno Hose clamps with bolt (pag. 208-210)  
 BANDI BLOCK - Par de apriete Tightening torque (pag. 221)



**NORMAS NORMS:**  
ISO 1307

**MARCADOR MARKING:**  
EUROCORD® WATER FLAT HOSE W.P. 10 BAR

**EMBALAJE BOX:**  
EMBALAJE EN POLIETILENO NEGRO  
PACKAGING IN BLACK POLYETHYLENE

**-25°C / +70°C**  
**-13°F / +158°F**

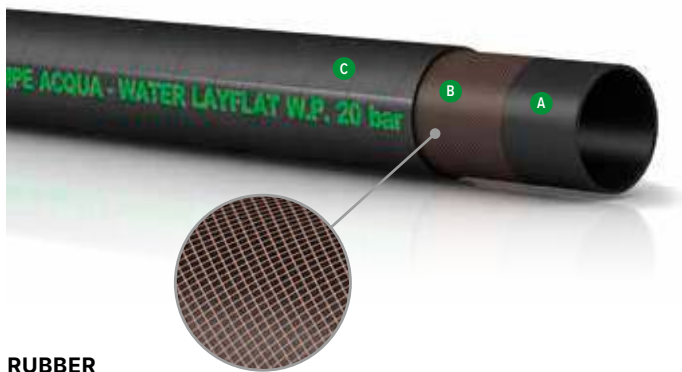

**RUBBER**



- **Manguera plana.**  
Flattenable.



**USO APPLICATIONS**

Para entrega y descarga de agua y fluidos no corrosivos. Normalmente se utiliza para acompañar bombas sumergibles o la conducción de agua en drenajes de aguas subterráneas. Se puede aplanar y enrollar en bobinas.

For water and non corrosive fluids delivery. Used in support to submersible pumps or to conveying water in groundwater. It could be flattened or wrapped.



**ESTRUCTURA BODY**









<b>A</b>	<b>Capa interior Tube</b>	Lisa en caucho SBR de color negro. Natural and synthetic black rubber.
<b>B</b>	<b>Refuerzos Reinforcement</b>	Textiles sintéticos. High tensile synthetic textile.
<b>C</b>	<b>Capa exterior Cover</b>	Lisa en caucho SBR/EPDM de color negro, resistente a la abrasión y a los agentes atmosféricos. Weather resistant synthetic rubber.
	<b>Superficie Surface</b>	Lisa con impresión de tela. Smooth with fabric impression.



**ABRAZADERAS Y COLLARES DE APRIETE RECOMENDADOS**  
**RECOMMENDED CLAMP/COLLAR**

STC - Abrazaderas con perno Hose clamps with bolt (pag. 208-210)  
BANDI BLOCK - Par de apriete Tightening torque (pag. 221)



 mm	 mm	 bar	 bar	 bar	 gr/mt	 mm	 m
25	36	20	60	-	714	-	40
30	40	20	60	-	747	-	40
32	42	20	60	-	782	-	40
40	50	20	60	-	945	-	40
42	52	20	60	-	998	-	40
45	55	20	60	-	1053	-	40
48	58	20	60	-	1080	-	40
50	60	20	60	-	1100	-	40
60	69	20	60	-	1274	-	40
70	79	20	60	-	1650	-	40
75	84	20	60	-	1717	-	40
80	90	20	60	-	1796	-	20-40
90	102	20	60	-	2444	-	20-40
102	113	20	60	-	2538	-	20-40
120	131	20	60	-	2930	-	20
153	164	20	60	-	3672	-	20



**NORMAS** NORMS:  
ISO 1307  
**MARCADOR** MARKING:  
EUROCORD® WATER RUBBER HOSE W.P. 20 BAR  
**EMBALAJE** BOX:  
EMBALAJE EN POLIETILENO NEGRO  
PACKAGING IN BLACK POLYETHYLENE



**-25°C / +70°C**  
**-13°F / +158°F**



PVC



- **Manguera plana.**  
Flattenable.

**USO APPLICATIONS**

Para entrega o descarga de agua y fluidos no corrosivos. Manguera extremadamente ligera, puede enrollarse y aplanarse después de su uso y es fácilmente transportable. Se utiliza sobre todo en la agricultura para el riego. También es excelente como vaina de protección.

For water and non corrosive fluids delivery. This hose is very light and could be wrapped or flattened after use. Easy to transport. Used in the agricultural sector and for the irrigation. Good also like a protection sleeve.



**ESTRUCTURA BODY**

<b>A</b> Capa interior Tube	Lisa en PVC de color negro. Flexible PVC lining.
<b>B</b> Refuerzos Reinforcement	Textiles sintéticos. High tensile synthetic textile.
<b>C</b> Capa exterior Cover	Lisa en PVC de color verde, resistente a la abrasión y a los agentes atmosféricos. Light chemicals and weather resistant PVC outer cover.
Superficie Surface	Verde o gris. Green or grey.

mm	mm	bar	bar	bar	gr/mt	mm	m
25	-	5	15	-	170	-	100
32	-	5	15	-	200	-	100
38	-	5	14	-	240	-	100
40	-	5	13	-	250	-	100
45	-	5	13	-	260	-	100
50	-	5	12	-	270	-	100
55	-	5	12	-	320	-	100
60	-	5	12	-	340	-	100
63	-	5	12	-	360	-	100
70	-	4	9	-	400	-	100
76	-	4	9	-	430	-	100
80	-	4	9	-	450	-	100
90	-	4	9	-	530	-	100
100	-	3	8	-	620	-	100
150	-	2	6	-	1100	-	100

**ABRAZADERAS Y COLLARES DE APRIETE RECOMENDADOS**  
RECOMMENDED CLAMP/COLLAR

- STC - Abrazaderas con perno Hose clamps with bolt (pag. 208-210)
- BANDI BLOCK - Par de apriete Tightening torque (pag. 221)



**NORMAS NORMS:**  
ISO 1307

**-5°C / +60°C**  
**+23°F / +140°F**



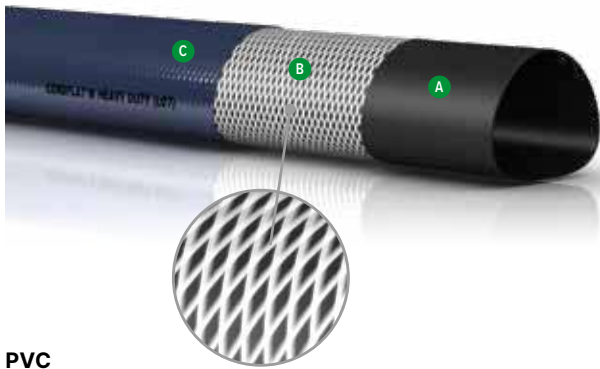

PVC



- **Manguera plana.**  
**Flattenable.**



**USO**  
**APPLICATIONS**

Para entrega o descarga de agua y fluidos no corrosivos. Manguera extremadamente ligera, puede enrollarse y aplanarse después de su uso y es fácilmente transportable. Se utiliza sobre todo en la agricultura para el riego. También es excelente como vaina de protección.

For water and non corrosive fluids delivery. This hose is very light and could be wrapped or flattened after use. Easy to transport. Used in the agricultural sector and for the irrigation. Good also like a protection sleeve.



**ESTRUCTURA**  
**BODY**

<b>A</b>	Capa interior Tube	Lisa en PVC de color negro. Flexible PVC lining.
<b>B</b>	Refuerzos Reinforcement	Textiles sintéticos. High tensile synthetic textile.
<b>C</b>	Capa exterior Cover	Lisa en PVC de color azul, resistente a la abrasión y a los agentes atmosféricos. Light chemicals and weather resistant PVC outer cover.
	Superficie Surface	Azul oscuro. Dark blue.



**ABRAZADERAS Y COLLARES DE APRIETE**  
**RECOMENDADOS**  
**RECOMMENDED CLAMP/COLLAR**

STC - Abrazaderas con perno Hose clamps with bolt (pag. 208-210)  
 BANDI BLOCK - Par de apriete Tightening torque (pag. 221)



mm	mm	bar	bar	bar	gr/mt	mm	m
32	-	8	20	-	220	-	50/100
38	-	7	18	-	260	-	50/100
40	-	7	18	-	280	-	50/100
45	-	7	18	-	310	-	50/100
50	-	7	18	-	360	-	50/100
60	-	6	16	-	430	-	50/100
63	-	6	16	-	440	-	50/100
70	-	6	16	-	470	-	50/100
76	-	6	16	-	520	-	50/100
80	-	6	16	-	560	-	50/100
90	-	6	14	-	640	-	50/100
100	-	4	14	-	760	-	50/100
150	-	3,5	9	-	1280	-	50/100
200	-	2,5	7	-	2000	-	50/100



NORMAS NORMS:  
 ISO 1307



-5°C / +60°C  
 +23°F / +140°F

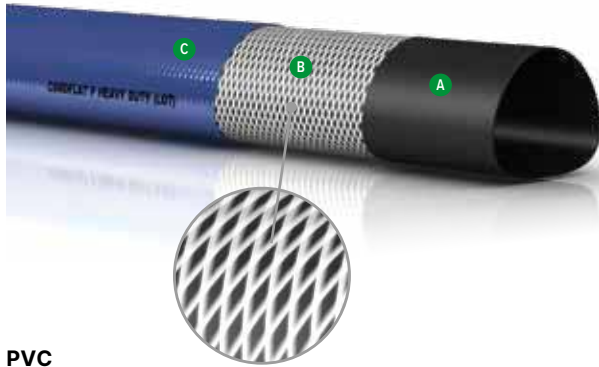

PVC



- **Manguera plana.**  
Flattenable.

**USO**  
APPLICATIONS

Para entrega o descarga de agua y fluidos no corrosivos. Manguera extremadamente ligera, puede enrollarse y aplanarse después de su uso y es fácilmente transportable. Se utiliza sobre todo en la agricultura para el riego. También es excelente como vaina de protección.

For water and non corrosive fluids delivery. This hose is very light and could be wrapped or flattened after use. Easy to transport. Used in the agricultural sector and for the irrigation. Good also like a protection sleeve.



**ESTRUCTURA**  
BODY

<b>A</b>	<b>Capa interior</b> Tube	Lisa en PVC de color negro. Flexible PVC lining.
<b>B</b>	<b>Refuerzos</b> Reinforcement	Textiles sintéticos. High tensile synthetic textile.
<b>C</b>	<b>Capa exterior</b> Cover	Lisa en PVC de color azul, resistente a la abrasión y a los agentes atmosféricos. Light chemicals and weather resistant PVC outer cover.
	<b>Superficie</b> Surface	Azul claro. Light blue.

mm	mm	bar	bar	bar	gr/mt	mm	m
25	-	12	35	-	225	-	50/100
30	-	10	30	-	250	-	50/100
32	-	10	30	-	260	-	50/100
35	-	10	25	-	280	-	50/100
38	-	10	25	-	300	-	50/100
40	-	10	25	-	320	-	50/100
45	-	10	25	-	350	-	50/100
51	-	9	25	-	410	-	50/100
60	-	9	25	-	540	-	50/100
63	-	9	25	-	560	-	50/100
70	-	9	25	-	620	-	50/100
76	-	9	25	-	680	-	50/100
80	-	9	25	-	740	-	50/100
90	-	9	25	-	860	-	50/100
100	-	8	23	-	1050	-	50/100
125	-	6	18	-	1350	-	50/100
152	-	4	11	-	1750	-	50/100
200	-	2,5	8	-	2400	-	50/100

**ABRAZADERAS Y COLLARES DE APRIETE**  
RECOMENDADOS  
RECOMMENDED CLAMP/COLLAR

- STC - Abrazaderas con perno Hose clamps with bolt (pag. 208-210)
- BANDI BLOCK - Par de apriete Tightening torque (pag. 221)



**NORMAS** NORMS:  
ISO 1307

**-5°C / +60°C**  
**+23°F / +140°F**

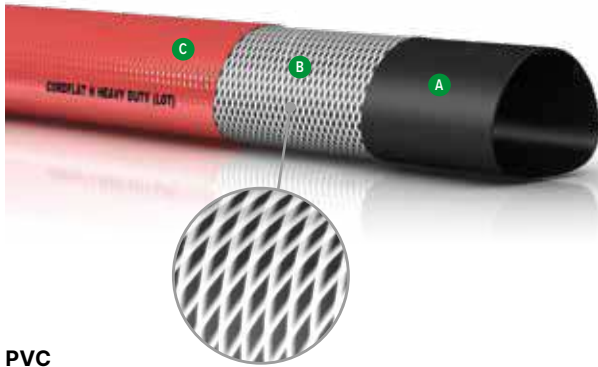

PVC



- **Manguera plana. Flattenable.**



**USO  
APPLICATIONS**

Para entrega o descarga de agua y fluidos no corrosivos. Manguera extremadamente ligera, puede enrollarse y aplanarse después de su uso y es fácilmente transportable. Se utiliza sobre todo en la agricultura para el riego. También es excelente como vaina de protección.

For water and non corrosive fluids delivery. This hose is very light and could be wrapped or flattened after use. Easy to transport. Used in the agricultural sector and for the irrigation. Good also like a protection sleeve.



**ESTRUCTURA  
BODY**

<b>A</b>	Capa interior Tube	Lisa en PVC de color negro. Flexible PVC lining.
<b>B</b>	Refuerzos Reinforcement	Textiles sintéticos. High tensile synthetic textile.
<b>C</b>	Capa exterior Cover	Lisa en PVC de color rojo, resistente a la abrasión y a los agentes atmosféricos. Light chemicals and weather resistant PVC outer cover.
	Superficie Surface	Rojo. Red.



**ABRAZADERAS Y COLLARES DE APRIETE  
RECOMENDADOS  
RECOMMENDED CLAMP/COLLAR**

STC - Abrazaderas con perno Hose clamps with bolt (pag. 208-210)  
BANDI BLOCK - Par de apriete Tightening torque (pag. 221)



mm	mm	bar	bar	bar	gr/mt	mm	m
38	-	16	48	-	450	-	50/100
40	-	16	48	-	490	-	50/100
45	-	16	48	-	520	-	50/100
51	-	16	48	-	600	-	50/100
63	-	16	48	-	840	-	50/100
76	-	13	33	-	960	-	50/100
80	-	13	13	-	1020	-	50/100
90	-	13	33	-	1150	-	50/100
100	-	13	33	-	1400	-	50/100
152	-	7	21	-	2750	-	50/100
200	-	5	15	-	3500	-	50/100
100	-	4	14	-	760	-	50/100
150	-	3,5	9	-	1280	-	50/100
200	-	2,5	7	-	2000	-	50/100



NORMAS NORMS:  
ISO 1307



-5°C / +60°C  
+23°F / +140°F



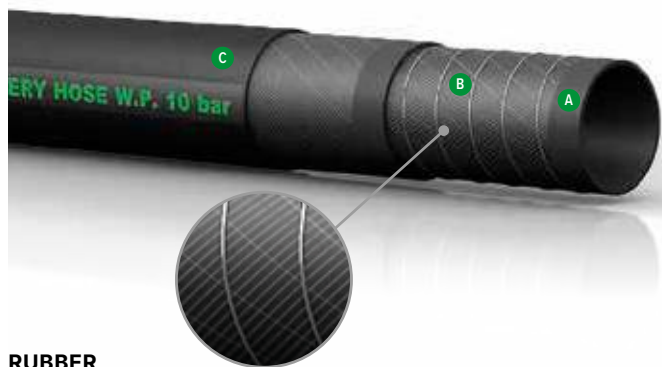

**RUBBER**



- **Manguera plana.**  
**Flattenable.**

**USO APPLICATIONS**

Para entrega y aspiración de agua y fluidos no corrosivos. Especialmente adecuada para diversos usos agrícolas e industriales.

For water and non corrosive fluids suction and delivery. Used in the agricultural and industrial sectors.



**ESTRUCTURA BODY**

<b>A</b>	<b>Capa interior Tube</b>	Caucho SBR de color negro. Natural and synthetic rubber.
<b>B</b>	<b>Refuerzos Reinforcement</b>	Textiles sintéticos y espiral metálica incorporada. High tensile synthetic textile and steel helix wire.
<b>C</b>	<b>Capa exterior Cover</b>	Lisa en caucho SBR/EPDM de color negro, resistente a la abrasión y a los agentes atmosféricos y al envejecimiento. Abrasion and weather resistant synthetic rubber
	<b>Superficie Surface</b>	Lisa con impresión de tela. Smooth with fabric impression.

mm	mm	bar	bar	bar	gr/mt	mm	m
19	29	10	30	0,8	575	152	40
25	36	10	30	0,8	741	200	40
30	41	10	30	0,8	909	240	40
32	43	10	30	0,8	961	256	40
35	46	10	30	0,8	1038	280	40
38	49	10	30	0,8	1240	304	40
40	51	10	30	0,8	1337	320	40
42	52	10	30	0,8	1380	336	40
45	57	10	30	0,8	1490	360	40
50	63	10	30	0,8	1745	408	40
60	73	10	30	0,8	2156	480	40
63	76	10	30	0,8	2325	504	40
70	84	10	30	0,8	2741	560	40
76	90	10	30	0,8	2963	608	40
80	94	10	30	0,8	3099	640	20-40
90	102	10	30	0,8	4238	720	20-40
100	114	10	30	0,8	4186	816	20-40
102	114	10	30	0,8	4186	816	20-40
110	126	10	30	0,8	4660	880	20
120	138	10	30	0,8	5981	960	20
127	144	10	30	0,8	5418	1016	20
150	172	10	30	0,8	8550	1216	20

**ABRAZADERAS Y COLLARES DE APRIETE RECOMENDADOS**  
**RECOMMENDED CLAMP/COLLAR**

STC - Abrazaderas con perno Hose clamps with bolt (pag. 208-210)  
BANDI BLOCK - Par de apriete Tightening torque (pag. 221)



**NORMAS NORMS:**  
ISO 1307  
**MARCADOR MARKING:**  
EUROCORD® RUBBER HOSE W.P. 10 BAR ISO 1307  
**EMBALAJE BOX:**  
EMBALAJE EN POLIETILENO NEGRO  
PACKAGING IN BLACK POLYETHYLENE



**-25°C / +70°C**  
**-13°F / +158°F**



**RUBBER**



**USO  
APPLICATIONS**

Adecuada para la aspiración y entrega de agua y fluidos no corrosivos. Fabricada en los tamaños específicos de aplicación con mangas lisas en los extremos para facilitar el montaje. Especialmente adecuada para diversos usos agrícolas e industriales.

For water and non corrosive fluids suction and delivery. Produced in various sizes with smooth cuffs ends, to help the installation. Normally used in agricultural and industrial uses.



**ESTRUCTURA  
BODY**

<b>A</b> Capa interior Tube	Caucho SBR de color negro. Natural and synthetic black rubber.
<b>B</b> Refuerzos Reinforcement	Textiles sintéticos y espiral metálica incorporada. High tensile synthetic textile and steel helix wire.
<b>C</b> Capa exterior Cover	Caucho SBR resistente al ozono y a los agentes atmosféricos. Weather and abrasion resistant smooth synthetic rubber.
Superficie Surface	Corrugada con impresión de tela con mangas en los extremos. Corrugated with fabric impression.



**ABRAZADERAS Y COLLARES DE APRIETE  
RECOMENDADOS  
RECOMMENDED CLAMP/COLLAR**

STC - Abrazaderas con perno Hose clamps with bolt (pag. 208-210)  
BANDI BLOCK - Par de apriete Tightening torque (pag. 221)



- Disponible en longitudes de aplicación.  
Available in different sizes.
- Mangas lisas en los extremos.  
With smooth cuff-ends.



mm	mm	mm	bar	bar	bar	gr/mt	mm	m
60	5	100	5	15	0,6	1645	180	2
76	5,5	100	5	15	0,6	2050	218	3
80	5	100	5	15	0,6	2236	240	2-3-6
102	7	120	5	15	0,6	3091	500	2-3-4-6
110	7	120	5	15	0,6	3633	550	2-3-5
120	7	120	5	15	0,6	4193	700	2-3-6
127	7	120	5	15	0,6	4397	750	2-3
133	7	80	5	9	0,6	4944	800	2/3
152	8	150	5	15	0,6	5976	950	2-3-4-6
203	9	180	3	9	0,6	9674	1200	2-3
254	9	200	3	9	0,6	11750	1500	2/3



**NORMAS** NORMS:  
ISO 1307  
**MARCADOR** MARKING:  
EUROCORD® ONDULATO SP W.P. 5 BAR  
**EMBALAJE** BOX:  
EMBALAJE EN POLIETILENO NEGRO  
PACKAGING IN BLACK POLYETHYLENE



**-25°C / +70°C**  
**-13°F / +158°F**



PVC



**USO  
APPLICATIONS**

Adecuada para entrega y la aspiración de líquidos inertes. Especialmente indicada para la agricultura, la construcción, etc. para acompañar a las bombas de aspiración.

For water and inert fluids suction and delivery. Normally used in the agricultural and industrial sectors in support of suction pumps.



**ESTRUCTURA  
BODY**

<b>A</b>	<b>Material</b>	PVC flexible. Strong, flexible and smooth plasticized PVC.
<b>B</b>	<b>Refuerzos</b> Reinforcement	Espiral en PVC antichoque. Shock resistant PVC spiral.
<b>C</b>	<b>Capa exterior</b> Cover	En PVC resistente a la abrasión, los agentes atmosféricos y el ozono. Crushing, chemical agents, abrasion and weather resistant, light corrugated outside.
	<b>Superficie</b> Surface	Ligeramente corrugada, de color verde transparente. Transparent green.

mm	mm	bar	bar	bar	gr/mt	mm	m
20	2,7	-	28	0,8	270	85	50
25	2,9	-	22	0,8	300	112	50
30	3,1	-	21	0,8	380	135	50
32	3,2	-	20	0,8	400	144	50
35	3,2	-	19	0,8	440	157	50
38	3,3	-	18	0,8	470	171	50
40	3,5	-	18	0,8	520	180	50
45	3,5	-	17	0,8	570	202	50
50	3,8	-	15	0,8	690	225	50
60	4	-	13	0,7	900	270	50
70	4,5	-	12	0,7	1080	315	50
75	4,6	-	12	0,7	1260	337	50
80	4,8	-	12	0,6	1440	360	50
90	5,1	-	11	0,6	1620	405	25
100	5,9	-	11	0,6	1980	459	25
110	6,1	-	11	0,5	2250	495	25
120	6,3	-	10	0,4	2520	540	25
125	6,6	-	10	0,4	2880	562	25
150	7	-	9	0,3	3870	675	25
200	8,5	-	7	0,2	5850	900	25



**ABRAZADERAS Y COLLARES DE APRIETE  
RECOMENDADOS  
RECOMMENDED CLAMP/COLLAR**

STF - Abrazaderas de tornillo Hose clamps with screw (pag. 204-207)

STC - Abrazaderas con perno Hose clamps with bolt (pag. 208-210)

BANDI BLOCK - Par de apriete Tightening torque (pag. 221)



NORMAS NORMS:  
ISO 1307



-5°C / +60°C  
+23°F / +140°F



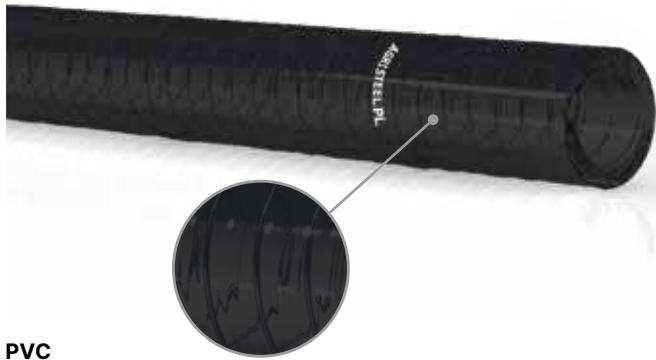

PVC



- **Manguera universal para entrega y aspiración de líquidos.**  
Liquids suction and delivery universal hose.
- **Extremadamente flexible.**  
Very flexible.



**USO APPLICATIONS**

Adecuada para entrega y excelente aspiración de líquidos. La espiral metálica le confiere una gran flexibilidad. Se emplea principalmente en sistemas de drenaje, máquinas agrícolas y bombas de aspiración.

Water and inert fluids suction and delivery. The steel spiral wire makes it very flexible. Used in agriculture applications, for the drainage systems, shipbuilding and suction pumps.



**ESTRUCTURA BODY**

<b>A</b>	<b>Material</b>	PVC flexible. PVC universal flexible hose.
<b>B</b>	<b>Refuerzos</b>	Espirál metálica incorporada. Steel spiral wire.
<b>C</b>	<b>Capa exterior</b>	En PVC resistente a la abrasión, los agentes atmosféricos y el ozono. Abrasion and weather resistant, PVC compound.
	<b>Superficie</b>	Lisa, de color negro opaco. Black, smooth.

mm	mm	bar	bar	bar	gr/mt	mm	m
12	3	7	-	0,85	180	25	60
13	3	6	-	0,85	190	27	60
14	3	6	-	0,85	200	30	60
16	3,1	6	-	0,85	225	35	60
18	3,1	6	-	0,85	280	40	60
20	3,1	5	-	0,85	340	50	60
22	3,2	5	-	0,85	370	55	60
25	3,2	5	-	0,85	510	60	60
30	3,5	4	-	0,85	600	70	60
32	3,9	4	-	0,85	650	75	30
35	4,2	4	-	0,85	730	80	30
38	4,4	4	-	0,85	800	90	30
40	4,5	3	-	0,85	870	95	30
45	5,1	3	-	0,8	1100	105	30
50	5,1	3	-	0,8	1200	125	30
60	6,5	2,5	-	0,7	1800	135	30



**ABRAZADERAS Y COLLARES DE APRIETE RECOMENDADOS**  
RECOMMENDED CLAMP/COLLAR

- STF - Abrazaderas de tornillo Hose clamps with screw (pag. 204-207)
- SGT - Abrazaderas pinzables Stepp less (pag. 216)
- SBS - Abrazaderas bifilares con resorte Double wire spring (pag. 217)



NORMAS NORMS:  
ISO 1307



-5°C / +60°C  
+23°F / +140°F

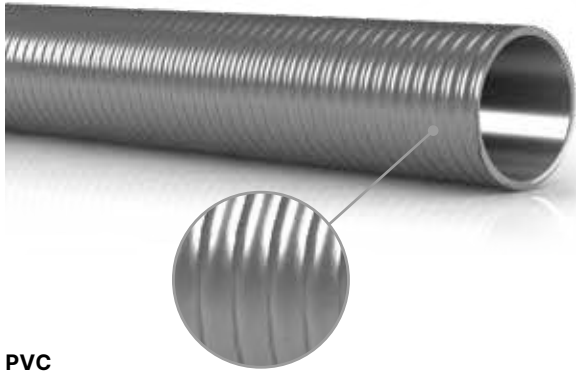

PVC



**USO**  
**APPLICATIONS**

Adecuada para entrega y aspiración de líquidos inertes y lodos. Estructura reforzada de alta resistencia. Especialmente indicada para los sectores del alcantarillado y la construcción.

For heavy-duty suction and delivery of water, salt water, light chemicals, liquids, etc. in agricultural, industrial applications and constructions.



**ESTRUCTURA**  
**BODY**

<b>A</b>	<b>Material</b>	PVC flexible. Strong, flexible and smooth plasticized PVC.
<b>B</b>	<b>Refuerzos</b> Reinforcement	Espiral en PVC antichoque. Shock resistant PVC spiral.
<b>C</b>	<b>Capa exterior</b> Cover	En PVC resistente a la abrasión, los agentes atmosféricos y el ozono. Crushing, chemical agents, abrasion and weather resistant, light corrugated outside.
	<b>Superficie</b> Surface	Ligeramente corrugada, de color gris metálico. Metallic grey, corrugated.



**ABRAZADERAS Y COLLARES DE APRIETE**  
**RECOMENDADOS**  
**RECOMMENDED CLAMP/COLLAR**

STC - Abrazaderas con perno Hose clamps with bolt (pag. 208-210)  
BANDI BLOCK - Par de apriete Tightening torque (pag. 221)



- **Estructura reforzada de alta resistencia.**  
Reinforced structure for heavy uses.



mm	mm	bar	bar	bar	gr/mt	mm	m
20	4,6	9	-	0,95	415	114	50
25	4,6	8	-	0,95	555	150	50
30	4,8	8	-	0,95	630	180	50
32	4,8	8	-	0,95	680	192	50
35	5	8	-	0,95	730	210	50
38	5	7	-	0,95	775	228	50
40	5	7	-	0,95	825	240	50
45	5,1	7	-	0,95	970	270	50
50	5,6	7	-	0,95	1165	300	50
60	5,9	7	-	0,95	1550	360	50
70	6,1	6	-	0,95	1845	420	50
75	6,2	6	-	0,95	1940	450	50
80	6,4	6	-	0,95	2135	480	50
90	6,6	6	-	0,95	2425	540	25
100	7,2	5	-	0,95	3200	600	25
110	7,8	5	-	0,95	3590	660	25
120	7,9	5	-	0,9	3880	720	25
125	8,3	5	-	0,9	4075	750	25
150	9,8	4	-	0,9	6110	900	25
200	12	3	-	0,9	8730	1200	25



**NORMAS** NORMS:  
ISO 1307



**-5°C / +60°C**  
**+23°F / +140°F**



PVC



- **Excelente flexibilidad y ligereza.**  
Great flexibility and lightness.



**USO**  
**APPLICATIONS**

Su especial estructura la hace extremadamente flexible y manejable. Especialmente diseñada por el vacío de alcantarillas y pozos negros, de hecho, se puede enrollar fácilmente en camiones cisterna. Buena resistencia a las fluctuaciones de temperatura.

Strong, flexible and smooth hose for medium duty suction and delivery of water, salt water, light chemicals, liquids, etc. in agricultural, industrial applications constructions, sewer purging, sludge, slurries, waste matter.



**ESTRUCTURA**  
**BODY**

<b>A</b>	<b>Material</b>	PVC super elástico. Special superelastic material.
<b>B</b>	<b>Refuerzos</b> Reinforcement	Espiral en PVC antichoque. Shock resistant PVC spiral.
<b>C</b>	<b>Capa exterior</b> Cover	En PVC resistente a la abrasión, los agentes atmosféricos y el ozono. Chemical agents, abrasion and weather resistant PVC compound.
	<b>Superficie</b> Surface	Ligeramente corrugada, de color verde/gris metálico. Metallic grey with green spiral, corrugated.



**ABRAZADERAS Y COLLARES DE APRIETE**  
**RECOMENDADOS**  
**RECOMMENDED CLAMP/COLLAR**

STC - Abrazaderas con perno Hose clamps with bolt (pag. 208-210)  
BANDI BLOCK - Par de apriete Tightening torque (pag. 221)



mm	mm	bar	bar	bar	gr/mt	mm	m
20	4	6	-	0,9	370	65	50
25	4	6	-	0,9	440	87	50
30	4,2	5,5	-	0,9	540	120	50
32	4,2	5,5	-	0,9	600	112	50
35	4,2	5,5	-	0,9	630	125	50
38	4,2	4,5	-	0,9	700	133	50
40	4,2	4,5	-	0,9	750	140	50
45	4,4	4,5	-	0,9	860	160	50
50	4,6	4,5	-	0,9	1010	176	50
60	5	4	-	0,9	1250	210	50
70	5,2	3,5	-	0,8	1580	245	50
75	5,4	3,5	-	0,8	1700	262	50
80	5,6	3,5	-	0,8	1830	280	50
90	5,7	3,5	-	0,8	2070	315	25
100	6,1	3	-	0,8	2600	357	25
110	6,3	3	-	0,8	3100	385	25
120	6,6	3	-	0,8	3450	420	25
125	6,7	3	-	0,8	3600	437	25
150	8	2	-	0,8	4800	525	25



**NORMAS** NORMS:  
ISO 1307



**-5°C / +60°C**  
**+23°F / +140°F**



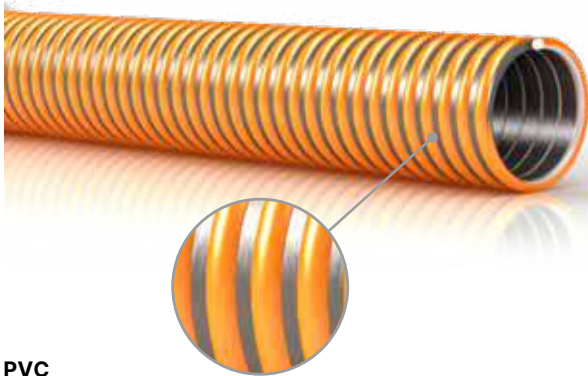

PVC



- **Resistencia a climas extremadamente fríos.**  
Low temperature resistant.



**USO APPLICATIONS**

Manguera lisa, ligera y flexible para trabajos medios de aspiración y entrega de agua, productos químicos ligeros, líquidos para uso doméstico, construcción, industria, purga, agricultura, sólidos abrasivos, especialmente para uso en climas extremadamente fríos.

Strong, flexible and smooth hose for medium duty suction and delivery of water, salt water, light chemicals, liquids, etc. in agricultural, industrial applications constructions, sewer purging, sludge, slurries, waste matter, sand and gravel, especially for use in cold climates.

**ESTRUCTURA BODY**

<b>A</b>	<b>Material</b>	Material especial superelástico. Special superelastic material.
<b>B</b>	<b>Refuerzos Reinforcement</b>	Espiral en PVC antichoque. Shock resistant PVC spiral.
<b>C</b>	<b>Capa exterior Cover</b>	En PVC resistente a la abrasión, los agentes atmosféricos y el ozono. Chemical agents, abrasion and weather resistant PVC compound.
	<b>Superficie Surface</b>	Ligeramente corrugada, de color naranja/gris. Metallic grey with orange spiral, corrugated.

mm	mm	bar	bar	bar	gr/mt	mm	m
19	-	-	16	0,9	360	65	50
25	-	-	16	0,9	480	80	50
30	-	-	14	0,9	560	90	50
32	-	-	13	0,9	580	95	50
35	-	-	12	0,9	640	105	50
38	-	-	12	0,9	670	115	50
40	-	-	11	0,9	700	120	50
45	-	-	11	0,9	870	140	50
51	-	-	11	0,9	975	155	50
55	-	-	11	0,9	1000	160	50
60	-	-	11	0,9	1250	185	50
63	-	-	10	0,9	1360	195	50
70	-	-	8	0,8	1580	220	50
76	-	-	8	0,8	1700	240	50
80	-	-	8	0,8	1800	250	30
90	-	-	7	0,8	2100	290	30
102	-	-	7	0,8	2600	320	30
110	-	-	7	0,8	2900	380	30
127	-	-	6	0,7	3860	500	30
152	-	-	6	0,7	5100	600	30
203	-	-	4	0,6	7850	800	10

**ABRAZADERAS Y COLLARES DE APRIETE RECOMENDADOS**  
**RECOMMENDED CLAMP/COLLAR**

STC - Abrazaderas con perno Hose clamps with bolt (pag. 208-210)  
BANDI BLOCK - Par de apriete Tightening torque (pag. 221)



**NORMAS** NORMS:  
ISO 1307

**-40°C / +50°C**  
**-40°F / +122°F**

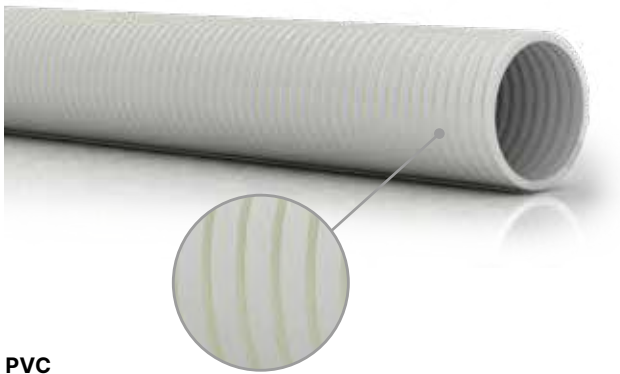

PVC



**USO  
APPLICATIONS**

Especialmente diseñada para transportar agua caliente al interior de bañeras de hidromasaje y piscinas. Su estructura especial, lisa por fuera, permite adherir fácilmente los racores correspondientes.

For transport of warm water in swimming pools, Jacuzzis, etc.











**ESTRUCTURA  
BODY**

<b>A</b>	<b>Material</b>	PVC resistente y flexible. Strong, flexible and smooth white hose in plasticized PVC.
<b>B</b>	<b>Refuerzos</b> Reinforcement	Espiral antiplastamiento en PVC. Shock resistant PVC spiral.
<b>C</b>	<b>Capa exterior</b> Cover	PVC. PVC.
	<b>Superficie</b> Surface	Blanco. White.



- **Estructura fácilmente conectable.**  
Easy fitted structure.



 mm	 mm	 bar	 bar	 bar	 gr/mt	 mm	 m
15	2,6	10	-	0,7	180	60	50
20	2,75	9	-	0,7	250	80	50
28	2	9	-	0,7	280	120	50
32	4	10	-	0,7	600	130	50
40	4	9	-	0,7	730	160	50
42	4	8	-	0,7	720	165	50
55	4	5	-	0,7	930	220	50



**NORMAS** NORMS:  
ISO 1307



**-5°C / +60°C**  
**+23°F / +140°F**

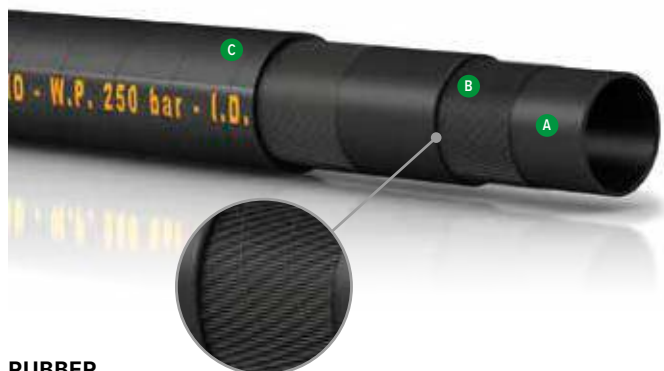

RUBBER



- Para la limpieza a alta presión.  
For high pressure cleaning.
- Puede suministrarse ya conectada.  
Available already with fittings.

### USO APPLICATIONS

Se utiliza habitualmente en la limpieza de alcantarillas a alta presión, incluso en condiciones de uso severas.

For high pressure water cleaning and rinsing of sewage systems.



### ESTRUCTURA BODY

<b>A</b>	<b>Capa interior Tube</b>	Caucho sintético especial. Special synthetic rubber.
<b>B</b>	<b>Refuerzos Reinforcement</b>	Refuerzo textil de alta tenacidad. High tensile synthetic textile.
<b>C</b>	<b>Capa exterior Cover</b>	Caucho sintético especial, liso, resistente a la abrasión, los aceites y a los agentes atmosféricos. Abrasion, oil and weather resistant smooth, special synthetic rubber.
	<b>Superficie Surface</b>	Lisa con impresión de tela. Smooth with fabric impression.

mm	mm	bar	bar	bar	gr/mt	mm	m
13	25	250	625	-	440	-	240
16	28	250	625	-	480	-	240
19	32	250	625	-	555	-	240
25	39	250	625	-	780	-	240
32	48	250	625	-	1060	-	200
38	54	250	625	-	1250	-	200

**NORMAS NORMS:**  
ISO 1307

**MARCADOR MARKING:**  
EUROCORD® WATER POWER HD - W.P. 250 BAR - I.D.

**EMBALAJE BOX:**  
EMBALAJE EN POLIETILENO NEGRO  
PACKAGING IN BLACK POLYETHYLENE

**-40°C / +50°C**  
**-40°F / +122°F**





### RUBBER



### USO APPLICATIONS

Se utiliza habitualmente para acompañar a los carretes en los vehículos contra incendios.

For fire fighting vehicles.



### ESTRUCTURA BODY

<b>A</b>	<b>Capa interior Tube</b>	Caucho natural y sintético. Natural and synthetic rubber.
<b>B</b>	<b>Refuerzos Reinforcement</b>	Refuerzo textil de alta tenacidad. High tensile synthetic textile.
<b>C</b>	<b>Capa exterior Cover</b>	Caucho sintético resistente a la llama, la abrasión, el ozono y los agentes atmosféricos. Flame, abrasion, weather and ozone resistant synthetic rubber.
	<b>Superficie Surface</b>	Lisa con impresión de tela. Smooth with fabric impression.

mm	mm	bar	bar	bar	gr/mt	mm	m
12,7	21,5	40	120	-	315	120	40-46-61
19	32,5	40	120	-	715	190	40-46-61
25,4	39	40	120	-	870	200	40-46-61
32	45	40	120	-	975	280	40-46-61



**NORMAS** NORMS:  
ISO 1307

**MARCADOR MARKING:**  
EUROCORD® FIGHTING HOSE TS EN ISO 1947:201  
- 2 TYPEC

**EMBALAJE BOX:**  
EMBALAJE EN POLIETILENO NEGRO  
PACKAGING IN BLACK POLYETHYLENE



**-25°C / +70°C**  
**-13°F / +158°F**

# MANGUERAS TRENZADAS PARA FUMIGACIÓN Y JARDINERÍA

BRAIDED SPRAYING AND GARDENING  
PVC HOSES

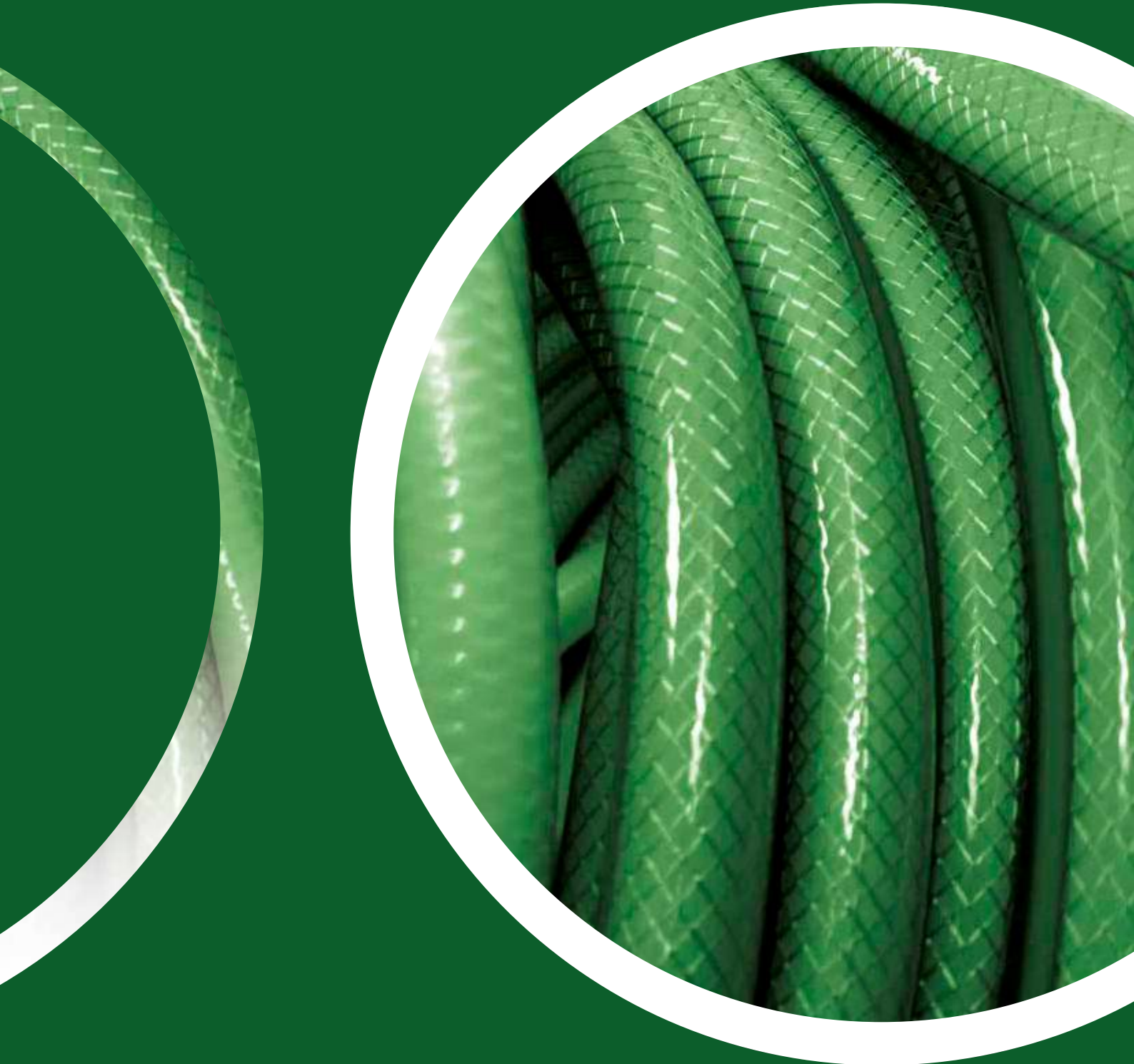



PVC



- Buena resistencia a los agentes atmosféricos. Weather resistant.
- Ideal para atomizadores o bombas manuales. Perfect for spraying machines or hand pumps.



**USO APPLICATIONS**

Adecuada para la fumigación en alta presión de fungicidas y herbicidas. Buena resistencia a los agentes atmosféricos. Especialmente indicada para acompañar pulverizadores o bombas manuales.

Suitable for high pressure of pesticides and fertilizers in agriculture. Weather resistant. Ideal for spraying machines or hand pumps.



**ESTRUCTURA BODY**

<b>A</b> Capa interior Tube	De color negro en PVC resistente a los fungicidas. Special PVC compound resistant to pesticides and fertilizers.
<b>B</b> Refuerzos Reinforcement	Textiles sintéticos. High tensile synthetic textile.
<b>C</b> Capa exterior Cover	Lisa en PVC resistente a la abrasión, los agentes atmosféricos y el ozono. Abrasion, ozone and weather resistant PVC.
Superficie Surface	Rojo - Negro con banda roja. Red - Black with red strip.



**ABRAZADERAS Y COLLARES DE APRIETE RECOMENDADOS RECOMMENDED CLAMP/COLLAR**

- STF - Abrazaderas de tornillo Hose clamps with screw (pag. 204-207)
- SBS - Abrazaderas bifilares con resorte Double wire spring (pag. 217)
- SGT - Abrazaderas pinzables Stepp less (pag. 216)



mm	mm	bar	bar	bar	gr/mt	mm	m
6	12	25	75	-	102	-	100
8	13	25	75	-	125	-	100
10	15	25	75	-	150	-	100
13	19	25	75	-	225	-	100
16	22	25	75	-	265	-	50
19	26	25	75	-	360	-	50



**NORMAS** NORMS:  
ISO 1307  
**MARCADOR** MARKING:  
FRUTCORD 25 BAR (LOT)



**-10°C / +60°C**  
**+14°F / +140°F**



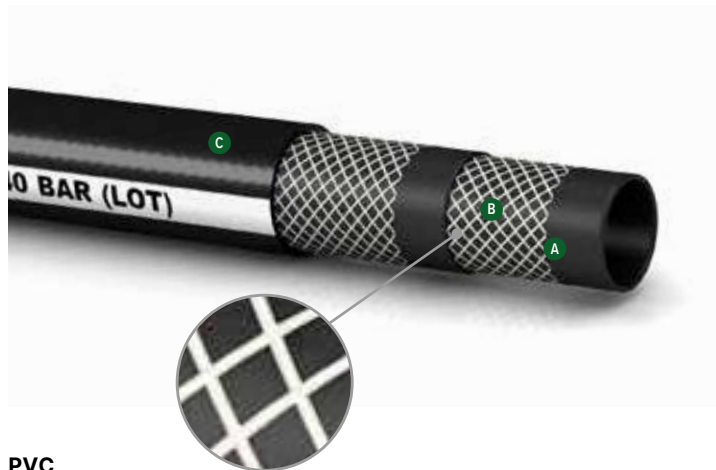

PVC



- Buena resistencia a los agentes atmosféricos. Weather resistant.
- Ideal para atomizadores o bombas manuales. Perfect for spraying machines or hand pumps.

**USO APPLICATIONS**

Adecuada para la fumigación en alta presión de fungicidas y herbicidas. Buena resistencia a los agentes atmosféricos. Especialmente indicada para acompañar pulverizadores o bombas manuales.

Suitable for high pressure of pesticides and fertilizers in agriculture. Weather resistant. Ideal for spraying machines or hand pumps.



**ESTRUCTURA BODY**

<b>A</b> Capa interior Tube	De color negro en PVC resistente a los fungicidas. Special PVC compound resistant to pesticides and fertilizers.
<b>B</b> Refuerzos Reinforcement	Textiles sintéticos. High tensile synthetic textile.
<b>C</b> Capa exterior Cover	Lisa en PVC resistente a la abrasión, los agentes atmosféricos y el ozono. Abrasion, ozone and weather resistant PVC.
Superficie Surface	Negro con banda blanca. Black with white strip.

mm	mm	bar	bar	bar	gr/mt	mm	m
8	14	40	120	-	158	-	100
10	16	40	120	-	185	-	100
13	19	40	120	-	225	-	100
16	23	40	120	-	300	-	50
19	26	40	120	-	360	-	50
25	34	40	120	-	565	-	50
32	44	40	120	-	723	-	50

**ABRAZADERAS Y COLLARES DE APRIETE RECOMENDADOS RECOMMENDED CLAMP/COLLAR**

STF - Abrazaderas de tornillo Hose clamps with screw (pag. 204-207)  
SGT - Abrazaderas pinzables Stepp less (pag. 216)



**NORMAS NORMS:**  
ISO 1307

**MARCADOR MARKING:**  
FRUCCORD 40 BAR (LOT)

**-10°C / +60°C**  
**+14°F / +140°F**



PVC



**USO  
APPLICATIONS**

Adecuada para la fumigación en alta presión de fungicidas y herbicidas. Buena resistencia a los agentes atmosféricos. Especialmente indicada para acompañar pulverizadores o bombas manuales.

Suitable for high pressure of pesticides and fertilizers in agriculture. Weather resistant. Ideal for spraying machines or hand pumps.



**ESTRUCTURA  
BODY**

<b>A</b> Capa interior Tube	De color negro en PVC resistente a los fungicidas. Special PVC compound resistant to pesticides and fertilizers.
<b>B</b> Refuerzos Reinforcement	Textiles sintéticos. High tensile synthetic textile.
<b>C</b> Capa exterior Cover	Lisa en PVC resistente a la abrasión, los agentes atmosféricos y el ozono. Abrasion, ozone and weather resistant PVC.
<b>Superficie Surface</b>	Azul oscuro - Negro con banda azul oscuro. Dark blue - Black with dark blue strip.



**ABRAZADERAS Y COLLARES DE APRIETE  
RECOMENDADOS  
RECOMMENDED CLAMP/COLLAR**

STF - Abrazaderas de tornillo Hose clamps with screw (pag. 204-207)  
SGT - Abrazaderas pinzables Stepp less (pag. 216)



- Buena resistencia a los agentes atmosféricos. Weather resistant.
- Ideal para atomizadores o bombas manuales. Perfect for spraying machines or hand pumps.



mm	mm	bar	bar	bar	gr/mt	mm	m
8	14	40	120	-	158	-	100
10	16	40	120	-	185	-	100
13	19	40	120	-	225	-	100
16	23	40	120	-	300	-	50
19	26	40	120	-	360	-	50
25	34	40	120	-	565	-	50
32	44	40	120	-	723	-	50



**NORMAS** NORMS:  
ISO 1307  
**MARCADOR** MARKING:  
FRUTCORD 40 BAR (LOT)



**-10°C / +60°C**  
**+14°F / +140°F**



PVC



- Buena resistencia a los agentes atmosféricos. Weather resistant.
- Ideal para atomizadores o bombas manuales. Perfect for spraying machines or hand pumps.



**USO APPLICATIONS**

Adecuada para la fumigación en alta presión de fungicidas y herbicidas. Buena resistencia a los agentes atmosféricos. Especialmente indicada para acompañar pulverizadores o bombas manuales.

Suitable for high pressure of pesticides and fertilizers in agriculture. Weather resistant. Ideal for spraying machines or hand pumps.

**ESTRUCTURA BODY**

<b>A</b> Capa interior Tube	De color negro en PVC resistente a los fungicidas. Special PVC compound resistant to pesticides and fertilizers.
<b>B</b> Refuerzos Reinforcement	Textiles sintéticos. High tensile synthetic textile.
<b>C</b> Capa exterior Cover	Lisa en PVC resistente a la abrasión, los agentes atmosféricos y el ozono. Abrasion, ozone and weather resistant PVC.
Superficie Surface	Beige - Negro con banda beige. Beige - Black with beige strip.

mm	mm	bar	bar	bar	gr/mt	mm	m
8	14,5	50	150	-	175	-	100
10	17	50	100	-	217	-	100

**ABRAZADERAS Y COLLARES DE APRIETE RECOMENDADOS RECOMMENDED CLAMP/COLLAR**

STF - Abrazaderas de tornillo Hose clamps with screw (pag. 204-207)  
SGT - Abrazaderas pinzables Stepp less (pag. 216)



**NORMAS NORMS:**  
ISO 1307

**MARCADOR MARKING:**  
FRUTCORD 50 BAR (LOT)

**-10°C / +60°C**  
**+14°F / +140°F**





PVC



- Buena resistencia a los agentes atmosféricos. Weather resistant.
- Ideal para atomizadores o bombas manuales. Perfect for spraying machines or hand pumps.



**USO APPLICATIONS**

Adecuada para la fumigación en alta presión de fungicidas y herbicidas. Buena resistencia a los agentes atmosféricos. Especialmente indicada para acompañar pulverizadores o bombas manuales.

Suitable for high pressure of pesticides and fertilizers in agriculture. Weather resistant. Ideal for spraying machines or hand pumps.



**ESTRUCTURA BODY**

<b>A</b> Capa interior Tube	De color negro en PVC resistente a los fungicidas. Special PVC compound resistant to pesticides and fertilizers.
<b>B</b> Refuerzos Reinforcement	Textiles sintéticos. High tensile synthetic textile.
<b>C</b> Capa exterior Cover	Lisa en PVC resistente a la abrasión, los agentes atmosféricos y el ozono. Abrasion, ozone and weather resistant PVC.
Superficie Surface	Verde oscuro - Negro con banda verde oscuro. Dark green - Black with dark green strip.



**ABRAZADERAS Y COLLARES DE APRIETE RECOMENDADOS RECOMMENDED CLAMP/COLLAR**

STF - Abrazaderas de tornillo Hose clamps with screw (pag. 204-207)  
SGT - Abrazaderas pinzables Stepp less (pag. 216)



mm	mm	bar	bar	bar	gr/mt	mm	m
8	15	80	200	-	185	-	100
10	18	80	200	-	245	-	100
13	22	80	200	-	260	-	100
16	25	80	160	-	402	-	50
19	29	80	160	-	580	-	50



**NORMAS** NORMS:  
ISO 1307  
**MARCADOR** MARKING:  
FRUTCORD 80 BAR (LOT)



**-10°C / +60°C**  
**+14°F / +140°F**



PVC



- Buena resistencia a los agentes atmosféricos. Weather resistant.
- Ideal para atomizadores o bombas manuales. Perfect for spraying machines or hand pumps.



**USO APPLICATIONS**

Adecuada para la fumigación en alta presión de fungicidas y herbicidas. Buena resistencia a los agentes atmosféricos. Especialmente indicada para acompañar pulverizadores o bombas manuales.

Suitable for high pressure of pesticides and fertilizers in agriculture. Weather resistant. Ideal for spraying machines or hand pumps.

**ESTRUCTURA BODY**

<b>A</b> Capa interior Tube	De color negro en PVC resistente a los fungicidas. Special PVC compound resistant to pesticides and fertilizers.
<b>B</b> Refuerzos Reinforcement	Textiles sintéticos. High tensile synthetic textile.
<b>C</b> Capa exterior Cover	Lisa en PVC resistente a la abrasión, los agentes atmosféricos y el ozono. Abrasion, ozone and weather resistant PVC.
Superficie Surface	Azul oscuro - Negro con banda azul oscuro. Dark blue - Black with dark blue strip.

**ABRAZADERAS Y COLLARES DE APRIETE RECOMENDADOS RECOMMENDED CLAMP/COLLAR**

STF - Abrazaderas de tornillo Hose clamps with screw (pag. 204-207)  
SGT - Abrazaderas pinzables Stepp less (pag. 216)



mm	mm	bar	bar	bar	gr/mt	mm	m
8	16	100	300	-	211	-	100
10	19	100	300	-	284	-	100
13	23	100	300	-	392	-	100

**NORMAS NORMS:**  
ISO 1307

**MARCADOR MARKING:**  
FRUTCORD 100 BAR (LOT)

**-10°C / +60°C**  
**+14°F / +140°F**

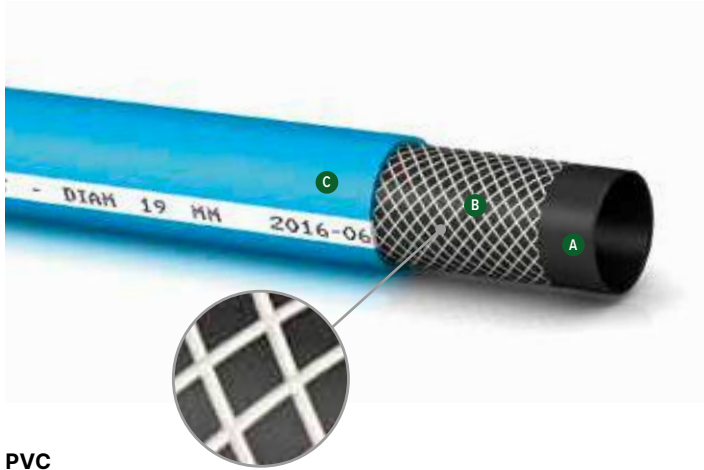

- **Extrema resistencia, suavidad y flexibilidad.**  
Extremely resistance, softness and flexibility.

PVC



**USO  
APPLICATIONS**

Manguera para jardinería con excelentes prestaciones. La colocación especial de los refuerzos textiles entre la capa exterior y la capa interior no permite que la manguera se anude o retuerza. Adecuada en el sector de la construcción, el naval, la agricultura y la floricultura.

Gardening hose with outstanding performances. The position of the high synthetic textile reinforcement between the cover and the sub layer doesn't permit the kinking of the hose. Suitable for the construction, marine, agricultural and flower growing industries.



**ESTRUCTURA  
BODY**

<b>A</b>	<b>Capa interior Tube</b>	PVC negro. Black plasticized PVC.
<b>B</b>	<b>Refuerzos Reinforcement</b>	Textiles sintéticos. High tensile synthetic textile.
<b>C</b>	<b>Capa exterior Cover</b>	Lisa en PVC resistente a la abrasión, los agentes atmosféricos y el ozono. Abrasion. ozone and weather resistant PVC.
	<b>Superficie Surface</b>	Azul claro con banda blanca. Light blue with white strip.

mm	mm	bar	bar	bar	gr/mt	mm	m
13	2,5	10	26	-	140	-	15/25/50
16	2,6	10	23	-	180	-	15/25/50
19	3,0	10	21	-	250	-	15/25/50
25	3,3	10	17	-	370	-	15/25/50



**ABRAZADERAS Y COLLARES DE APRIETE  
RECOMENDADOS  
RECOMMENDED CLAMP/COLLAR**

STF - Abrazaderas de tornillo Hose clamps with screw (pag. 204-207)



NORMAS NORMS:  
ISO 1307



-5°C / +60°C  
+23°F / +140°F



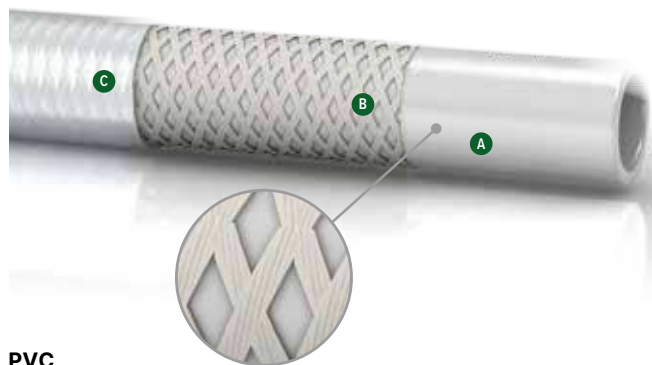

PVC



- **Resistente a las manchas.**  
Stain resistant.



**USO**  
**APPLICATIONS**









Manguera para jardinería. Extremadamente robusta y flexible. Especialmente adecuada en la industria y la construcción naval, ya que es resistente a las manchas.

Gardening, irrigation and general water discharge.



**ESTRUCTURA**  
**BODY**

<b>A</b>	<b>Capa interior</b> Tube	PVC blanco. White PVC.
<b>B</b>	<b>Refuerzos</b> Reinforcement	Textiles sintéticos. High tensile synthetic textile.
<b>C</b>	<b>Capa exterior</b> Cover	Lisa en PVC resistente a la abrasión, los agentes atmosféricos y el ozono. Abrasion, ozone and weather resistant PVC.
	<b>Superficie</b> Surface	Blanca. White plasticized PVC.

 mm	 mm	 bar	 bar	 bar	 gr/mt	 mm	 m
10	2,5	10	30	-	110	-	25/50
13	2,8	10	32	-	170	-	25/50
16	2,8	10	32	-	200	-	25/50
19	3,0	10	32	-	260	-	25/50
22	3,0	10	21	-	300	-	25/50
25	3,5	10	32	-	420	-	25/50
30	4,0	5	15	-	529	-	25/50



**ABRAZADERAS Y COLLARES DE APRIETE**  
**RECOMENDADOS**  
**RECOMMENDED CLAMP/COLLAR**

STF - Abrazaderas de tornillo Hose clamps with screw (pag. 204-207)



**NORMAS** NORMS:  
ISO 1307



**-5°C / +60°C**  
**+23°F / +140°F**

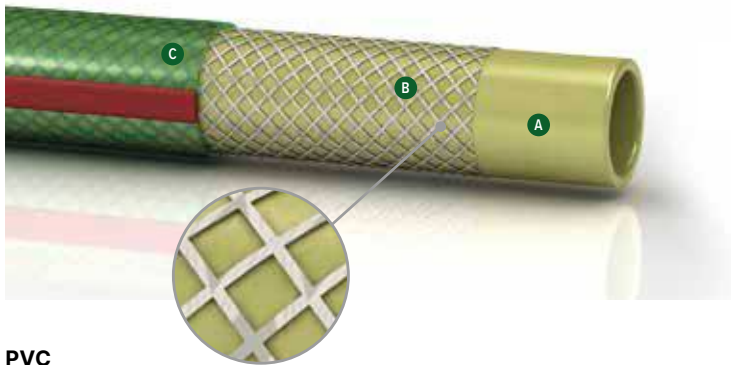

**PVC**



**USO  
APPLICATIONS**

Manguera para jardinería. Extremadamente robusta y flexible. Especialmente indicada para la industria naval, de la construcción y de la marina.

Gardening hose. Extremely strong and flexible. Suitable for the marine and construction industries.



**ESTRUCTURA  
BODY**









<b>A</b>	<b>Capa interior Tube</b>	PVC amarillo. Yellow plasticized PVC.
<b>B</b>	<b>Refuerzos Reinforcement</b>	Textiles sintéticos. High tensile synthetic textile.
<b>C</b>	<b>Capa exterior Cover</b>	Lisa en PVC resistente a la abrasión, los agentes atmosféricos y el ozono. Abrasion, ozone and weather resistant PVC.
	<b>Superficie Surface</b>	Verde con banda roja. Green with red strip.



**ABRAZADERAS Y COLLARES DE APRIETE  
RECOMENDADOS  
RECOMMENDED CLAMP/COLLAR**

STF - Abrazaderas de tornillo Hose clamps with screw (pag. 204-207)



 mm	 mm	 bar	 bar	 bar	 gr/mt	 mm	 m
10	2,5	10	30	-	110	-	25/50
13	2,8	10	32	-	170	-	25/50
16	2,8	10	32	-	200	-	25/50
19	3	10	32	-	260	-	25/50
22	3	10	21	-	300	-	25/50
25	3,5	10	32	-	420	-	25/50
30	4	5	15	-	529	-	25/50



**NORMAS NORMS:**  
ISO 1307



**-5°C / +60°C  
+23°F / +140°F**

# MANGUERAS PARA AIRE COMPRIMIDO

COMPRESSED AIR HOSES

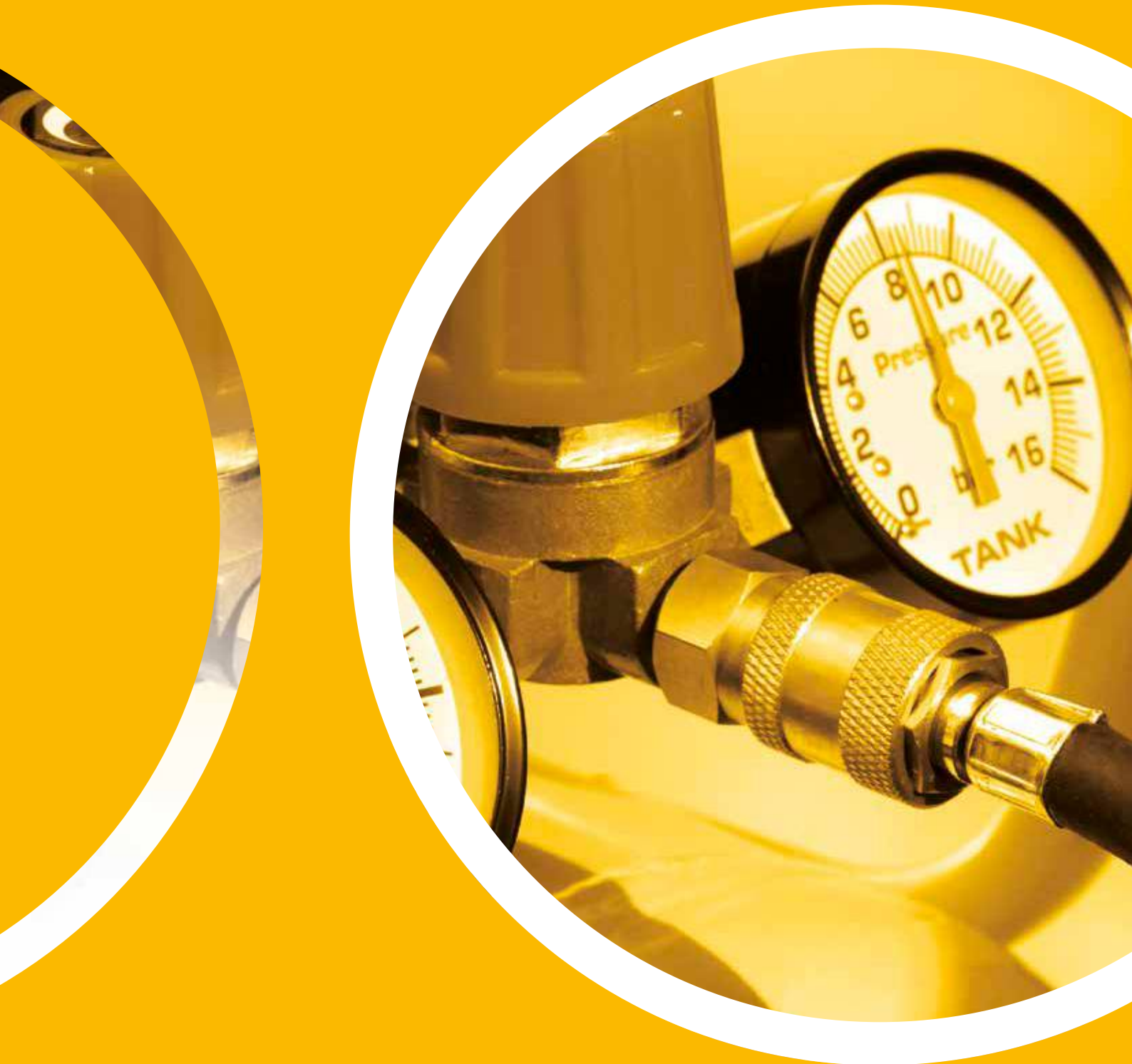





**RUBBER**



**USO  
APPLICATIONS**

Para entrega de aire comprimido, agua y líquidos no corrosivos, cuando se requiere ligereza y flexibilidad. Se utiliza en muchas aplicaciones agrícolas e industriales.

Medium duty service for air and pneumatic tools specially in industrial and agriculture applications.



**ESTRUCTURA  
BODY**









<b>A</b>	<b>Capa interior Tube</b>	Lisa en caucho SBR de color negro. Natural and synthetic black rubber.
<b>B</b>	<b>Refuerzos Reinforcement</b>	Textiles sintéticos. High tensile synthetic textile.
<b>C</b>	<b>Capa exterior Cover</b>	Lisa en caucho SBR/EPDM de color negro resistente a la abrasión y a los agentes atmosféricos. Abrasion, ozone and weather resistant smooth natural and synthetic rubber.
	<b>Superficie Surface</b>	Lisa. Smooth.



**ABRAZADERAS Y COLLARES DE APRIETE  
RECOMENDADOS  
RECOMMENDED CLAMP/COLLAR**

STF - Abrazaderas de tornillo Hose clamps with screw (pag. 204-207)  
SGT - Abrazaderas pinzables Stepp less (pag. 216)



 mm	 mm	 bar	 bar	 bar	 gr/mt	 mm	 m
6	14	20	60	-	190	60	100
7	16	20	60	-	245	70	100
8	17	20	60	-	265	80	100
10	19	20	60	-	310	100	100
13	23	20	60	-	425	130	100
16	26	20	60	-	495	160	50
19	30	20	60	-	635	190	50
25	37	20	60	-	800	250	50



**NORMAS NORMS:**  
ISO 1307  
**MARCADOR MARKING:**  
EUROCORD® RUBBER HOSE W.P. 20 BAR ISO 1307  
**EMBALAJE BOX:**  
EMBALAJE EN POLIETILENO AMARILLO  
PACKAGING IN YELLOW POLYETHYLENE



**-25°C / +70°C  
-13°F / +158°F**



PVC



- **Máxima ligereza.**  
Maximum lightness.

**USO APPLICATIONS**

Adecuada para entrega de agua y aire comprimido cuando se requiere ligereza y flexibilidad. Especialmente indicada en la agricultura, la construcción y la industria naval.

Medium duty service for air and pneumatic tools specially in industrial and agriculture applications.



**ESTRUCTURA BODY**

<b>A</b>	<b>Capa interior Tube</b>	Lisa en PVC de color negro. Special PVC resistant compound.
<b>B</b>	<b>Refuerzos Reinforcement</b>	Textiles sintéticos. High tensile synthetic textile.
<b>C</b>	<b>Capa exterior Cover</b>	Lisa en PVC de color negro resistente a la abrasión y a los agentes atmosféricos. Abrasion and weather resistant special thermorub compound.
	<b>Superficie Surface</b>	Negro. Black.

mm	mm	bar	bar	bar	gr/mt	mm	m
6	14	20	60	-	189	-	100
8	17	20	60	-	266	-	100
10	19	20	60	-	308	-	100
13	23	20	60	-	423	-	100
16	26	20	60	-	495	-	50
19	30	20	60	-	636	-	50
25	37	20	60	-	780	-	50

**ABRAZADERAS Y COLLARES DE APRIETE RECOMENDADOS RECOMMENDED CLAMP/COLLAR**

STF - Abrazaderas de tornillo Hose clamps with screw (pag. 204-207)

SGT - Abrazaderas pinzables Stepp less (pag. 216)



**NORMAS** NORMS:  
ISO 1307

**-10°C / +60°C**  
**+14°F / +140°F**

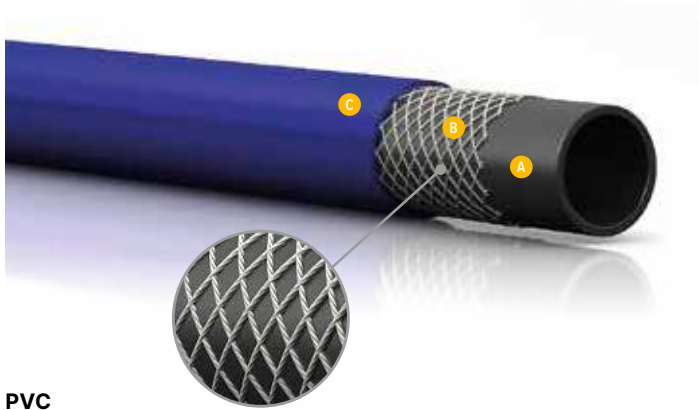

PVC



- **Mezcla especial en poliuretano antiabrasivo y PVC.**  
Special anti abrasive polyuretane compound and PVC.



**USO APPLICATIONS**

Adecuada para entrega de agua y aire comprimido cuando se requiere ligereza y flexibilidad. Especialmente indicada en la agricultura, la construcción y la industria naval.

Suitable for the water and air compressed delivery where it is necessary lightness and flexibility. Ideal for the industrial, agricultural, construction and marine industries.



**ESTRUCTURA BODY**

<b>A</b>	<b>Capa interior Tube</b>	Liso en PU de color negro. Smooth black PU compound.
<b>B</b>	<b>Refuerzos Reinforcement</b>	Textiles sintéticos. High tensile synthetic textile.
<b>C</b>	<b>Capa exterior Cover</b>	Lisa en PVC de color azul resistente a la abrasión y a los agentes atmosféricos. Abrasion, ozone and weather resistant PVC compound.
	<b>Superficie Surface</b>	Azul. Blue.

mm	mm	bar	bar	bar	gr/mt	mm	m
6	10	20	60	-	70	-	100
8	12	20	60	-	85	-	100
10	15	20	60	-	135	-	100
13	19	20	60	-	195	-	100



**ABRAZADERAS Y COLLARES DE APRIETE RECOMENDADOS**  
RECOMMENDED CLAMP/COLLAR

STF - Abrazaderas de tornillo Hose clamps with screw (pag. 204-207)  
SGT - Abrazaderas pinzables Stepp less (pag. 216)



NORMAS NORMS:  
ISO 1307



-10°C / +60°C  
+14°F / +140°F



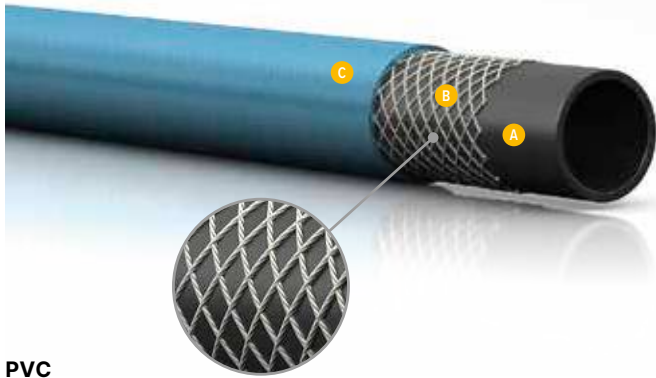

PVC



**USO  
APPLICATIONS**

Adecuada para entrega de agua y aire comprimido cuando se requiere ligereza y flexibilidad. Especialmente indicada en la agricultura, la construcción y la industria naval.

Suitable for the water and air compressed delivery where it is necessary lightness and flexibility. Ideal for the industrial, agricultural, construction and marine industries.



**ESTRUCTURA  
BODY**









<b>A</b>	<b>Capa interior</b> Tube	Mezcla termoplástica de color negro. Special thermorub compound.
<b>B</b>	<b>Refuerzos</b> Reinforcement	Textiles sintéticos. High tensile synthetic textile.
<b>C</b>	<b>Capa exterior</b> Cover	Mezcla termoplástica de color azul. Abrasion, weather and oil resistant special thermorub compound.
	<b>Superficie</b> Surface	Azul claro. Light blue.



**ABRAZADERAS Y COLLARES DE APRIETE  
RECOMENDADOS  
RECOMMENDED CLAMP/COLLAR**

STF - Abrazaderas de tornillo Hose clamps with screw (pag. 204-207)  
SGT - Abrazaderas pinzables Stepp less (pag. 216)



 mm	 mm	 bar	 bar	 bar	 gr/mt	 mm	 m
6	12	25	75	-	110	-	100
8	13	25	75	-	108	-	100
10	15	25	75	-	129	-	100
13	19	25	75	-	195	-	100



**NORMAS NORMS:**  
ISO 1307



**-10°C / +60°C**  
**+14°F / +140°F**



**RUBBER**



**USO APPLICATIONS**

Adecuada para entrega de aire a compresores, equipos de perforación y máquinas neumáticas en general. Se utiliza especialmente en obras, canteras y minas.

Suitable for the air delivery of compressors, and pneumatic tools. Ideal for building sites, caves or mines.



**ESTRUCTURA BODY**









<b>A</b>	Capa interior Tube	Caucho SBR de color negro. Natural and synthetic rubber.
<b>B</b>	Refuerzos Reinforcement	Textiles sintéticos. High tensile synthetic textile.
<b>C</b>	Capa exterior Cover	Caucho SBR/EPDM resistente a la abrasión, los agentes atmosféricos y al envejecimiento. Abrasion, ozone and weather resistant synthetic rubber.
	Superficie Surface	Lisa con impresión de tela. Smooth with fabric impression.



**ABRAZADERAS Y COLLARES DE APRIETE RECOMENDADOS RECOMMENDED CLAMP/COLLAR**

STF - Abrazaderas de tornillo Hose clamps with screw (pag. 204-207)  
 STC - Abrazaderas con perno Hose clamps with bolt (pag. 208-210)



 mm	 mm	 bar	 bar	 bar	 gr/mt	 mm	 m
8	17	20	60	-	247	80	40
10	19	20	60	-	286	100	40
13	23	20	60	-	397	130	40
16	26	20	60	-	435	160	40
19	30	20	60	-	550	190	40
25	37	20	60	-	757	250	40



**NORMAS** NORMS:  
 ISO 1307  
**MARCADOR** MARKING:  
 EUROCORD® AIR COMPRESSED HOSE W.P. 20 BAR  
**EMBALAJE** BOX:  
 EMBALAJE EN POLIETILENO AMARILLO  
 PACKAGING IN YELLOW POLYETHYLENE



**-25°C / +70°C**  
**-13°F / +158°F**



**RUBBER**



**USO APPLICATIONS**

Adecuada para entrega de aire a compresores, equipos de perforación y máquinas neumáticas en general. Se utiliza especialmente en obras, canteras y minas.

Suitable for the air delivery of compressors, and pneumatic tools. Ideal for building sites, caves or mines.



**ESTRUCTURA BODY**









<b>A</b> Capa interior Tube	Caucho SBR de color negro. Natural and synthetic rubber.
<b>B</b> Refuerzos Reinforcement	Textiles sintéticos. High tensile synthetic textile.
<b>C</b> Capa exterior Cover	Caucho SBR/EPDM resistente a la abrasión, los agentes atmosféricos y al envejecimiento. Abrasion, ozone and weather resistant synthetic rubber.
Superficie Surface	Lisa con impresión de tela. Smooth with fabric impression.



**ABRAZADERAS Y COLLARES DE APRIETE RECOMENDADOS  
RECOMMENDED CLAMP/COLLAR**

STF - Abrazaderas de tornillo Hose clamps with screw (pag. 204-207)  
STC - Abrazaderas con perno Hose clamps with bolt (pag. 208-210)



 mm	 mm	 bar	 bar	 bar	 gr/mt	 mm	 m
19	32	25	75	-	695	190	40
25	39	25	75	-	929	250	40
32	48	25	75	-	1423	320	40
38	54	25	75	-	1570	380	40
40	56	25	75	-	1630	400	40
50	69	25	75	-	2333	510	40
60	83	25	75	-	3637	600	40
76	96	25	75	-	3766	760	40



**NORMAS NORMS:**  
ISO 1307  
**MARCADOR MARKING:**  
EUROCORD® AIR COMPRESSED HOSE W.P. 25 BAR  
**EMBALAJE BOX:**  
EMBALAJE EN POLIETILENO AMARILLO  
PACKAGING IN YELLOW POLYETHYLENE



**-25°C / +70°C**  
**-13°F / +158°F**





**RUBBER**



**USO APPLICATIONS**

Adecuada para entrega de aire a compresores, equipos de perforación y máquinas neumáticas en general. Se utiliza especialmente en obras, canteras y minas.

Suitable for the air delivery of compressors, and pneumatic tools. Ideal for building sites, caves or mines.



**ESTRUCTURA BODY**









<b>A</b> Capa interior Tube	Caucho NBR de color negro, adecuado para entrega de aire y neblina de aceite. Synthetic NBR rubber, resistant to high pressure and inert fluids.
<b>B</b> Refuerzos Reinforcement	Refuerzos de acero de alta resistencia. High tensile synthetic textile.
<b>C</b> Capa exterior Cover	Caucho sintético microperforado resistente a la abrasión, los agentes atmosféricos y el envejecimiento. Abrasion, ozone and weather resistant synthetic rubber.
<b>Superficie Surface</b>	Lisa con impresión de tela. Smooth with fabric impression.



**ABRAZADERAS Y COLLARES DE APRIETE RECOMENDADOS RECOMMENDED CLAMP/COLLAR**

STF - Abrazaderas de tornillo Hose clamps with screw (pag. 204-207)  
STC - Abrazaderas con perno Hose clamps with bolt (pag. 208-210)



 mm	 mm	 bar	 bar	 bar	 gr/mt	 mm	 m
12,7	23	40	160	-	640	153	40
19	30	40	160	-	666	228	40
25,4	36	40	160	-	884	305	40
32	43	40	160	-	1138	384	40
38	50	40	160	-	1600	456	40
51	66	40	160	-	2450	612	40
63,5	80	35	140	-	3560	762	40
76,2	94	30	120	-	4740	915	40
102	122	30	120	-	6232	1219	40



**NORMAS NORMS:**  
ISO 1307  
**MARCADOR MARKING:**  
EUROCORD® AIR COMPRESSED HOSE W.P. 40 BAR  
**EMBALAJE BOX:**  
EMBALAJE EN POLIETILENO AMARILLO  
PACKAGING IN YELLOW POLYETHYLENE



**-25°C / +70°C**  
**-13°F / +158°F**

# MANGUERAS PARA ACEITES, ÓLEO Y CARBURANTES

OIL AND FUEL HOSES



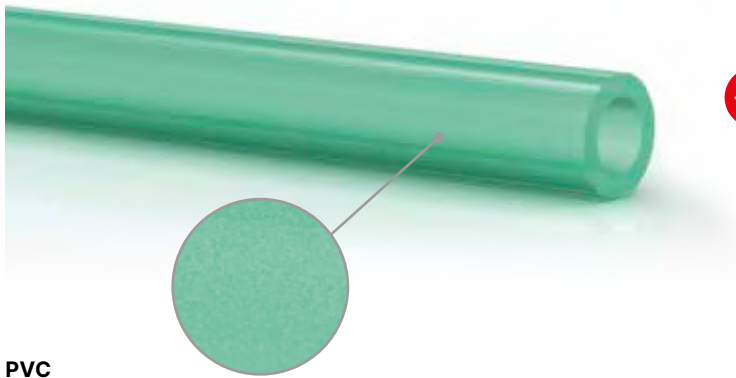

PVC



• Puede suministrarse en bobina.  
Available also on reel.



**USO  
APPLICATIONS**

Adecuada para entrega de aceites minerales, óleo y carburantes y gasolina verde, lubricación y engranaje de maquinaria; especialmente indicada cuando se requiere ligereza y flexibilidad.

Suitable for delivery of mineral oils, fuels, lubricant and machinery gear; particularly suitable where they are required of lightness and flexibility characteristics.



**ESTRUCTURA  
BODY**

<b>A</b>	Capa interior Tube	PVC verde transparente. Transparent green PVC.
<b>B</b>	Refuerzos Reinforcement	---
<b>C</b>	Capa exterior Cover	Lisa con impresión de tela. Smooth with fabric impression.
	Superficie Surface	Verde transparente. Transparent green PVC.



**ABRAZADERAS Y COLLARES DE APRIETE  
RECOMENDADOS  
RECOMMENDED CLAMP/COLLAR**

- STF - Abrazaderas de tornillo Hose clamps with screw (pag. 204-207)
- SGT - Abrazaderas pinzables Stepp less (pag. 216)
- SBS - Abrazaderas bifilares con resorte Double wire spring (pag. 217)



 mm	 mm	 bar	 bar	 bar	 gr/mt	 mm	 m
4	7	5	15	-	31	-	25
5	9	5	15	-	53	-	25
7	12	5	15	-	91	-	25
8	13	5	15	-	100	-	25
9	14	5	15	-	111	-	25
10	15	4	12	-	120	-	25



NORMAS NORMS:  
ISO 1307



-5°C / +60°C  
+23°F / +140°F





RUBBER



- Resistente a aceites, óleo y carburantes con un contenido de aromáticos de hasta el 40%.  
Oils and fuels with 40% aromatic contents resistant.
- Puede suministrarse en bobina.  
Available also on reel.



**USO APPLICATIONS**

Adecuada para suministro de combustibles en motores de combustión interna, lubricación y engrase de maquinaria; especialmente indicada cuando se requiere ligereza y flexibilidad.

For delivery of fuels in internal combustion engines for lubrication and greasing services. Particularly recommended where it is necessary flexibility and lightness.



**ESTRUCTURA BODY**

<b>A</b> Capa interior Tube	Lisa en caucho NBR de color negro resistente a aceites, óleo y carburantes con un contenido aromático de hasta el 40%. Natural and synthetic black rubber.
<b>B</b> Refuerzos Reinforcement	Textiles sintéticos. High tensile synthetic textile.
<b>C</b> Capa exterior Cover	Lisa en caucho NBR resistente al aceite y al carburante. Oil and Diesel resistant smooth synthetic rubber.
Superficie Surface	Lisa. Smooth.

mm	mm	bar	bar	bar	gr/mt	mm	m
4	9	10	30	-	70	40	100
5	12	10	30	-	124	50	100
6	12	10	30	-	113	60	100
8	15	10	30	-	169	80	100
10	17	10	30	-	198	100	100
13	20	10	30	-	244	130	100
15	23	10	30	-	321	150	50
19	27	10	30	-	389	190	50
25	35	10	30	-	630	250	50

**ABRAZADERAS Y COLLARES DE APRIETE RECOMENDADOS RECOMMENDED CLAMP/COLLAR**

- STF - Abrazaderas de tornillo Hose clamps with screw (pag. 204-207)
- STM - Abrazaderas de apriete Hose clamps (pag. 213)
- SGT - Abrazaderas pinzables Stepp less (pag. 216)



**NORMAS** NORMS:  
ISO 1307  
**MARCADOR** MARKING:  
EUROCORD® OIL RUBBER HOSE P.E. 10 BAR - ISO 1307  
**EMBALAJE** BOX:  
EMBALAJE EN POLIETILENO ROJO  
PACKAGING IN RED POLYETHYLENE



**-35°C / +70°C**  
**-31°F / +158°F**



**RUBBER**



- **Resistente a aceites, óleo y carburantes con un contenido de aromáticos de hasta el 40%.  
Oils and fuels with 40% aromatic contents resistant.**



**USO  
APPLICATIONS**

Adecuada para suministro de combustibles en motores de combustión interna, lubricación y engrase de maquinaria; especialmente indicada cuando se requiere ligereza y flexibilidad.

For delivery of fuels in internal combustion engines for lubrication and greasing services. Particularly recommended where it is necessary flexibility and lightness.



**ESTRUCTURA  
BODY**









<b>A</b> <b>Capa interior Tube</b>	Lisa en caucho NBR de color negro resistente a aceites, óleo y carburantes con un contenido aromático de hasta el 40%. Natural and synthetic black rubber.
<b>B</b> <b>Refuerzos Reinforcement</b>	Textiles sintéticos. High tensile synthetic textile.
<b>C</b> <b>Capa exterior Cover</b>	Lisa en caucho NBR resistente al aceite y al carburante. Oil and Diesel resistant smooth synthetic rubber.
<b>Superficie Surface</b>	Lisa. Smooth.



**ABRAZADERAS Y COLLARES DE APRIETE  
RECOMENDADOS  
RECOMMENDED CLAMP/COLLAR**

- STF - Abrazaderas de tornillo Hose clamps with screw (pag. 204-207)
- STM - Abrazaderas de apriete Hose clamps (pag. 213)
- SGT - Abrazaderas pinzables Stepp less (pag. 216)



 mm	 mm	 bar	 bar	 bar	 gr/mt	 mm	 m
6	14	20	60	-	168	60	100
8	17	20	60	-	237	80	100
10	19	20	60	-	275	100	100



**NORMAS** NORMS: ISO 1307  
**MARCADOR MARKING:**  
 EUROCORD® OIL RUBBER HOSE P.E. 20 BAR - ISO 1307  
**EMBALAJE BOX:**  
 EMBALAJE EN POLIETILENO ROJO  
 PACKAGING IN RED POLYETHYLENE



**-35°C / +70°C**  
**-31°F / +158°F**



**RUBBER**



- **Resistente a aceites, óleo y carburantes con un contenido de aromáticos de hasta el 40%.  
Oils and fuels with 40% aromatic contents resistant.**

**USO APPLICATIONS**

Adecuada para suministro de combustibles en motores de combustión interna, lubricación y engrase de maquinaria; especialmente indicada cuando se requiere ligereza y flexibilidad.

For delivery of fuels in internal combustion engines for lubrication and greasing services. Particularly recommended where it is necessary flexibility and lightness.



**ESTRUCTURA BODY**

<b>A</b> Capa interior Tube	Lisa en caucho NBR de color negro resistente a aceites, óleo y carburantes con un contenido aromático de hasta el 40%. Fuel and oil resistant, smooth nbr rubber.
<b>B</b> Refuerzos Reinforcement	Textiles sintéticos. High tensile synthetic textile.
<b>C</b> Capa exterior Cover	Lisa en caucho NBR resistente al aceite y al carburante. Abrasion, ozone, weather and oil resistant special synthetic rubber.
Superficie Surface	Lisa. Smooth.

mm	mm	bar	bar	bar	gr/mt	mm	m
6	14	25	75	-	168	120	100
8	16	25	75	-	228	180	100
10	18	25	75	-	275	100	100
13	21	25	75	-	300	130	50
16	25	25	75	-	392	160	50
19	29	25	75	-	490	190	50
25	36	25	75	-	539	210	50

**ABRAZADERAS Y COLLARES DE APRIETE RECOMENDADOS RECOMMENDED CLAMP/COLLAR**

- STF - Abrazaderas de tornillo Hose clamps with screw (pag. 204-207)
- STM - Abrazaderas de apriete Hose clamps (pag. 213)
- SGT - Abrazaderas pinzables Stepp less (pag. 216)



**NORMAS NORMS:**  
ISO 1307

**MARCADOR MARKING:**  
EUROCORD® OIL RUBBER HOSE P.E. 25 BAR - ISO 1307

**EMBALAJE BOX:**  
EMBALAJE EN POLIETILENO ROJO  
PACKAGING IN RED POLYETHYLENE

**-35°C / +70°C**  
**-31°F / +158°F**



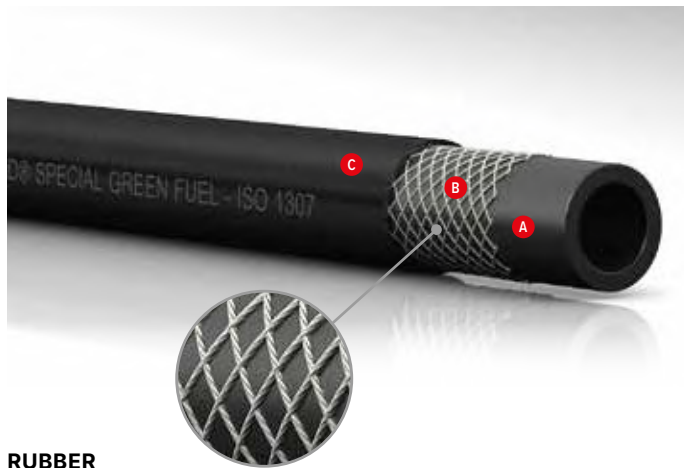

**RUBBER**



**USO APPLICATIONS**

Para entrega de carburantes, gasóleo, gasolina sin plomo, gasóleo ecológico y lubricantes en general. Se utiliza en motores de combustión interna de turismos, vehículos industriales, tractores y motores marinos.

For delivery of fuels, diesel & fuel, unleaded petrol fuels, eco diesel and lubricants in general. Used for the cars, industrial vehicles, tractors and marine motors combustion engines.



**ESTRUCTURA BODY**

<b>A</b> Capa interior Tube	Lisa en caucho NBR negro, resistente a aceites minerales, carburantes con un contenido aromático no superior al 50% y gasolina sin plomo con un contenido de MTBE no superior al 5%. Fuel and oil resistant, smooth NBR rubber.
<b>B</b> Refuerzos Reinforcement	Textiles sintéticos. High tensile synthetic textile.
<b>C</b> Capa exterior Cover	Caucho negro (CR/NBR) resistente a lubricantes, carburantes, a la abrasión y a los agentes atmosféricos. Weather and abrasion resistant smooth synthetic rubber.
Superficie Surface	Lisa. Smooth.



**ABRAZADERAS Y COLLARES DE APRIETE RECOMENDADOS RECOMMENDED CLAMP/COLLAR**

- STF - Abrazaderas de tornillo Hose clamps with screw (pag. 204-207)
- STM - Abrazaderas de apriete Hose clamps (pag. 213)
- SGT - Abrazaderas pinzables Stepp less (pag. 216)



- Resistente a aceites, óleo y carburantes con un contenido de aromáticos de hasta el 50%.  
Oils and fuels with 50% aromatic contents resistant.
- Resistente a la gasolina sin plomo con MTBE hasta el 5%.  
Unleaded petrol fuels with 5% MTPE resistant.
- Puede suministrarse en bobina.  
Available also on reel.



mm	mm	bar	bar	bar	gr/mt	mm	m
4	9	10	30	-	60	40	100
5	10	10	30	-	80	50	100
6	13	10	30	-	140	60	100
7	13	10	30	-	130	70	100
8	14,5	10	30	-	160	80	100
10	16	10	30	-	170	100	100



**NORMAS** NORMS:  
ISO 1307  
**MARCADOR** MARKING:  
EUROCORD® SPECIAL GREEN FUEL - ISO 1307  
**EMBALAJE** BOX:  
EMBALAJE EN POLIETILENO TRANSPARENTE  
PACKAGING IN TRANSPARENT POLYETHYLENE



**-35°C / +70°C**  
**-31°F / +158°F**



RUBBER



- **Resistente a aceites, óleo y carburantes con un contenido de aromáticos de hasta el 50%.  
Oils and fuels with 50% aromatic contents resistant.**
- **Resistente a la gasolina sin plomo con MTBE hasta el 5%.  
Unleaded petrol fuels with 5% MTPE resistant.**

**USO APPLICATIONS**

Adecuada para entrega de gasóleo y carburante en los sectores de la automoción y la marina.

Suitable for transfer diesel and fuel in automotive and marine engine.



**ESTRUCTURA BODY**

<b>A</b> Capa interior Tube	NBR negro, liso, resistente a los hidrocarburos, con hasta un 50% de contenido aromático. NBR black oil/fuel rubber, smooth, resistant to maximum 50% aromatic contents.
<b>B</b> Refuerzos Reinforcement	Textiles sintéticos de alta tenacidad. High tensile synthetic textile.
<b>C</b> Capa exterior Cover	Lisa en caucho sintético, resistente a la llama, la abrasión y a los agentes atmosféricos. Resistente al calor y al aceite. Synthetic rubber compound, flame resistant, abrasion, ozone, weather, heat and oil resistant rubber.
Superficie Surface	Lisa. Smooth.

mm	mm	bar	bar	bar	gr/mt	mm	m
4	9	10	30	-	0,078	40	100
6	12	10	30	-	0,118	60	100
7	13	10	30	-	0,133	70	100
8	15	10	30	-	0,176	80	100
10	17	10	30	-	0,208	100	100
13	20	10	30	-	0,254	120	100
16	24	10	30	-	0,352	160	50
19	27	10	30	-	0,404	190	50

**ABRAZADERAS Y COLLARES DE APRIETE RECOMENDADOS RECOMMENDED CLAMP/COLLAR**

STF - Abrazaderas de tornillo Hose clamps with screw (pag. 204-207)

STM - Abrazaderas de apriete Hose clamps (pag. 213)

SGT - Abrazaderas pinzables Stepp less (pag. 216)



**NORMAS NORMS:**  
94/25/ CE, AMEND. DIRECT. 2003/44/CE - ISO 7840:2013- A1 AND LLOYD'S - NMMA APPROVED

**MARCADOR MARKING:** EUROCORD® EN ISO 7840:2013 A1 E E10/B10 - COMPATIBLE R.I.N.A APPROVED - CE - YEAR - FUEL HOSE SAE J 1527:2011 USCG R1 - LLOYD'S APPROVED

**EMBALAJE BOX:**  
EMBALAJE EN POLIETILENO TRANSPARENTE  
PACKAGING IN TRANSPARENT POLYETHYLENE



**-35°C / +110°C**  
**-31°F / +230°F**



RUBBER



- Conforme con las normas DIN 73379. DIN 73379 approved.



### USO APPLICATIONS

Para entrega de carburante en motores de combustión interna o para lubricación y engrase en diversos servicios.

For delivery of fuels in internal combustion engines for lubrication and greasing services.



### ESTRUCTURA BODY

<b>A</b>	<b>Capa interior Tube</b>	Caucho NBR negro liso, resistente a aceites, óleo y carburantes. Fuel and oil resistant, smooth NBR rubber.
<b>B</b>	<b>Refuerzos Reinforcement</b>	Refuerzo textil de alta tenacidad. High tensile synthetic textile.
<b>C</b>	<b>Capa exterior Cover</b>	Caucho especial CR negro liso, resistente a aceites, óleo y carburantes, a la abrasión y a los agentes atmosféricos. Abrasion, flame, ozone, weather and oil resistant special CR rubber.
	<b>Superficie Surface</b>	Lisa. Smooth.



### ABRAZADERAS Y COLLARES DE APRIETE RECOMENDADOS RECOMMENDED CLAMP/COLLAR

- STF - Abrazaderas de tornillo Hose clamps with screw (pag. 204-207)  
 STM - Abrazaderas de apriete Hose clamps (pag. 213)  
 SGT - Abrazaderas pinzables Stepp less (pag. 216)



mm	mm	bar	bar	bar	gr/mt	mm	m
3,5	9,5	10	30	-	85	45	50
4	10	10	30	-	90	45	50
4,5	10,5	10	30	-	100	50	50
4,5	11,5	10	30	-	120	50	50
5	11	10	30	-	105	55	50
5	12	10	30	-	130	55	50
5,5	11,5	10	30	-	110	60	50
6	12	10	30	-	115	60	50
6	13	10	30	-	105	60	50
7	12	10	30	-	105	60	50
7	13	10	30	-	130	70	50
7,3	13,3	10	30	-	135	70	50
7,3	14,3	10	30	-	165	70	50
7,5	14,5	10	30	-	135	80	50
8	14	10	30	-	145	80	50
8	15	10	30	-	175	80	50
9	15	10	30	-	155	80	50
9,5	15,3	10	30	-	155	80	50
10	16	10	30	-	170	80	50
10	17	10	30	-	205	80	50
11	17	10	30	-	185	80	50
11	18	10	30	-	220	80	50
11,5	18,5	10	30	-	230	80	50
12,5	20	10	30	-	265	80	50
14	22	10	30	-	315	100	50
16	24	10	30	-	350	100	50



**NORMAS** NORMS:  
DIN 73379 TYPE 2A - ISO 1307

**MARCADOR MARKING:**  
EUROCORD® DIN 73379 2A FUEL&OIL MM . NBR/CR

**EMBALAJE BOX:**  
EMBALAJE EN POLIETILENO ROJO  
PACKAGING IN RED POLYETHYLENE



**-30°C / +90°C**  
**-22°F / +194°F**



**RUBBER**

**USO APPLICATIONS**









Manguera para entrega en presión de fluidos a base de urea acuosa AUS 32 (ADBLUE) en una concentración no superior al 33%. Puede utilizarse en equipos e instalaciones de diversos tipos.

Flexible hose for delivery of AUS 32 (ADBLUE) up to 33%.



**ESTRUCTURA BODY**

<b>A</b> Capa interior Tube	Lisa, negra, en mezcla con base de alta calidad de EPDM. Smooth black EPDM rubber.
<b>B</b> Refuerzos Reinforcement	Textiles sintéticos. High tensile synthetic textile.
<b>C</b> Capa exterior Cover	Lisa en caucho EPDM de color negro, resistente a la temperatura, a la abrasión, a los agentes atmosféricos y al ozono. Abrasion, heat, ozone and weather resistant, smooth EPDM rubber.
Superficie Surface	Lisa. Smooth.

 mm	 mm	 bar	 bar	 bar	 gr/mt	 mm	 m
13	20	10	30	-	280	130	50-100
19	27	10	30	-	340	190	50-100
25	35	10	30	-	550	250	50-100

**ABRAZADERAS Y COLLARES DE APRIETE RECOMENDADOS**  
**RECOMMENDED CLAMP/COLLAR**

- STF - Abrazaderas de tornillo Hose clamps with screw (pag. 204-207)
- STM - Abrazaderas de apriete Hose clamps (pag. 213)
- SGT - Abrazaderas pinzables Stepp less (pag. 216)



**NORMAS** NORMS:  
ISO 1307 - ISO 22241-2

**MARCADOR** MARKING:  
EUROCORD® POWERBLUE WP 10 BAR ISO 22241-2

**EMBALAJE** BOX:  
EMBALAJE EN POLIETILENO TRANSPARENTE  
PACKAGING IN TRANSPARENT POLYETHYLENE

**-40°C / +100°C**  
con picos de hasta  
with peaks up to  
+120°C

**-22°F / +194°F**  
con picos de hasta  
with peaks up to  
+230°F



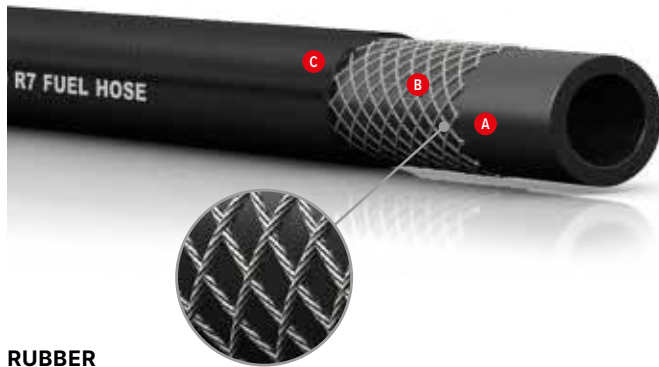

**RUBBER**



**USO  
APPLICATIONS**

Adecuada para entrega de fluidos hidráulicos, aceites minerales, lubricantes, gasóleo, gasolina.

Can be used as a fuel line. Suitable for the delivery of unleaded fuels and diesel oils especially in the automotive sectors.



**ESTRUCTURA  
BODY**









<b>A</b>	<b>Capa interior Tube</b>	Caucho sintético de color negro. Black synthetic rubber.
<b>B</b>	<b>Refuerzos Reinforcement</b>	1 trenza de hilo sintético de alta resistencia. 1 spiral textile.
<b>C</b>	<b>Capa exterior Cover</b>	Caucho sintético resistente a los agentes atmosféricos, la abrasión, los aceites, óleo y carburantes. Black and smooth synthetic rubber, ozone, abrasion and oil resistant.
	<b>Superficie Surface</b>	Lisa. Smooth.



**ABRAZADERAS Y COLLARES DE APRIETE  
RECOMENDADOS  
RECOMMENDED CLAMP/COLLAR**

- STF - Abrazaderas de tornillo Hose clamps with screw (pag. 204-207)
- STM - Abrazaderas de apriete Hose clamps (pag. 213)
- SGT - Abrazaderas pinzables Stepp less (pag. 216)



 mm	 mm	 bar	 bar	 bar	 gr/mt	 mm	 m
5	11	10	30	-	95	50	100
6	12	10	30	-	120	60	100
7	13	10	30	-	130	70	100
8	14	10	30	-	150	80	100
10	16	10	30	-	200	100	100
13	20	10	30	-	290	130	50
16	24	10	30	-	352	160	50
19	27	10	30	-	405	190	50
25	35	10	30	-	660	250	50



**NORMAS** NORMS:  
ISO 1307 - SAE J30 R7  
**MARCADOR** MARKING:  
EUROCORD® SAE J30 R7 FUEL HOSE  
**EMBALAJE** BOX:  
EMBALAJE EN POLIETILENO ROJO  
PACKAGING IN RED POLYETHYLENE



**-30°C / +120°C**  
**-22°F / +248°F**



RUBBER

**USO  
APPLICATIONS**

Adecuada para entrega de carburante sin plomo (EN 228:2017) y diésel (EN 590:2017) para turismos, camiones y tractores. Apta para B100 (100 % biodiésel = RME), B20, B7 (EN 590:2017), E5 (EN 228:2017), E10, E85 y E100. El revestimiento utilizado también cumple la clase A de la RMA.

Suitable for the delivery of unleaded fuels (EN 228:2017) and diesel oils (EN 590:2017) for cars, trucks and tractors. Suitable for B100 (100% biodiesel = RME), B20, B7 (EN 590:2017), E5 (EN 228:2017), E10, E85 and E100. The used liner fulfills RMA class A.



**ESTRUCTURA  
BODY**

<b>A</b>	<b>Capa interior Tube</b>	Caucho NBR de color negro. Black NBR rubber.
<b>B</b>	<b>Refuerzos Reinforcement</b>	Textiles. Spiral textile.
<b>C</b>	<b>Capa exterior Cover</b>	Caucho sintético negro liso resistente al ozono, la abrasión y los aceites. Black and smooth syntetic rubber, ozone, abrasion and oil resistant.
	<b>Superficie Surface</b>	Lisa. Smooth.

mm	mm	bar	bar	bar	gr/mt	mm	m
5	11	12	36	-	95	30	50
6	12	12	36	-	120	36	50
7	13	12	36	-	130	42	50
8	14	12	36	-	150	48	50
10	16	12	36	-	200	60	50

**ABRAZADERAS Y COLLARES DE APRIETE  
RECOMENDADOS  
RECOMMENDED CLAMP/COLLAR**

STF - Abrazaderas de tornillo Hose clamps with screw (pag. 204-207)

STM - Abrazaderas de apriete Hose clamps (pag. 213)

SGT - Abrazaderas pinzables Stepp less (pag. 216)



**NORMAS NORMS:**  
SAE J30R2 - SAE J30R6  
**MARCADOR MARKING:**  
EUROCORD® SAE J30 R2 SAE J30R6 W.P 12 BAR  
**EMBALAJE BOX:**  
EMBALAJE EN POLIETILENO ROJO  
PACKAGING IN RED POLYETHYLENE



**-30°C / +100°C  
-22°F / +212°F**

# EASY LOCK/LN SAE 100 R6

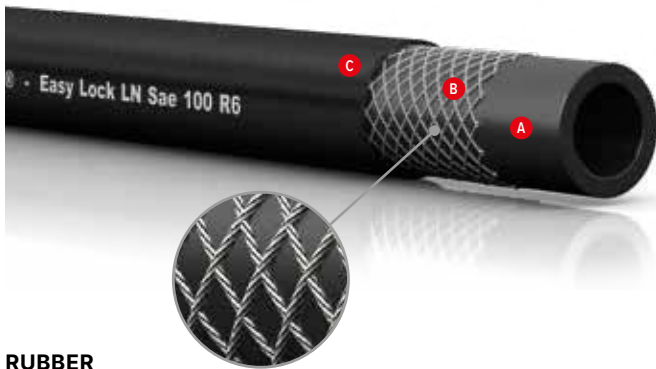

**RUBBER**



- Especialmente diseñada para sistemas de unión Push Lock. Suitable for Push Lock connection systems.



## USO APPLICATIONS









Para el paso a baja presión de fluidos hidráulicos a base de aceite mineral, petróleo crudo, agua y aire comprimido, etc.

For hydraulic control lines, discharge under low pressure of hydraulic fluids, fuel oil, grease, air and water.



## ESTRUCTURA BODY

<b>A</b> Capa interior Tube	Caucho sintético especial, resistente a los aceites hidráulicos. Hydraulic oil resistant special synthetic rubber.
<b>B</b> Refuerzos Reinforcement	1 trenza sintética, resistente a los aceites hidráulicos.i. 1 high tensile sythetic textile braid.
<b>C</b> Capa exterior Cover	Caucho sintético especial resistente al aceite, al ozono, a la abrasión y a los agentes atmosféricos. Oil, abrasion, ozone and weather resistant special synthetic rubber.
Superficie Surface	Lisa. Smooth.

 mm	 mm	 bar	 bar	 bar	 gr/mt	 mm	 m
4,8	10,7	34	136	-	90	50	>10
6,4	12,3	28	112	-	110	65	>10
8	13,9	28	112	-	130	80	>10
9,5	15,5	28	112	-	150	80	>10
12,7	19,5	28	112	-	220	100	>10
16	22,6	24	96	-	260	125	>10
19	25,8	21	84	-	310	150	>10
25,4	33,234	20	80	-	460	170	>10



**NORMAS** NORMS:  
SAE 100 R6 - ISO 1307 - EN854 TYPE R6 - TS6388  
EN854 TIP36 - ISO4079-1 R6

**MARCADOR** MARKING:  
EUROCORD® EASY LOCK LN SAE 100 R6

**EMBALAJE** BOX:  
EMBALAJE EN POLIETILENO ROJO  
PACKAGING IN RED POLYETHYLENE



**-40°C / +100°C**  
**-40°F / +212°F**



**RUBBER**

- **Antiestático.**  
Antistatic.

**USO APPLICATIONS**

Adecuada para entrega de aceites minerales, gasóleo, gasolina y carburantes. Especialmente adecuada para la descarga y carga solamente por impulsión de camiones cisterna, en refinerías y estaciones de servicio.

Suitable for mineral oils, diesel fuels, and fuels in general delivery. Particularly used for the unloading and loading of gas stations.

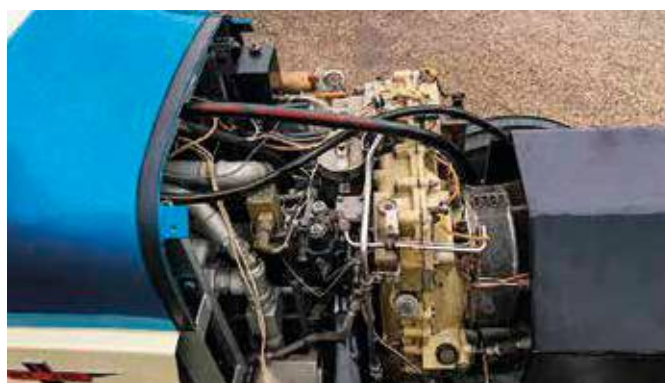

**ESTRUCTURA BODY**

<b>A</b> Capa interior Tube	Caucho NBR de color negro, resistente al carburante, con un contenido aromático no superior al 50%. Oil and petrol resistant, black NBR.
<b>B</b> Refuerzos Reinforcement	Textiles y sintéticos con cordón de cobre para garantizar la disipación de la electricidad estática. High tensile synthetic textile and antistatic copper wire.
<b>C</b> Capa exterior Cover	Caucho NBR/SBR resistente a los combustibles, aceites, ozono y a los agentes atmosféricos. Abrasion, ozone, weather and oil resistant special synthetic rubber.
Superficie Surface	Lisa con impresión de tela. Smooth with fabric impression.

mm	mm	bar	bar	bar	gr/mt	mm	m
19	27	10	30	-	380	190	40
22	30	10	30	-	424	220	40
25	35	10	30	-	615	250	40
30	40	10	30	-	693	300	40
32	42	10	30	-	751	320	40
35	45	10	30	-	880	350	40
40	50	10	30	-	914	400	40
45	56	10	30	-	1137	450	40
50	62	10	30	-	1280	500	40
60	72	10	30	-	1598	600	40

**ABRAZADERAS Y COLLARES DE APRIETE RECOMENDADOS**  
RECOMMENDED CLAMP/COLLAR

STF - Abrazaderas de tornillo Hose clamps with screw (pag. 204-207)  
STC - Abrazaderas con perno Hose clamps with bolt (pag. 208-210)



**NORMAS** NORMS:  
ISO 1307

**MARCADOR** MARKING:  
EUROCORD® OIL DELIVERY HOSE W.P. 10 BAR

**EMBALAJE** BOX:  
EMBALAJE EN POLIETILENO ROJO  
PACKAGING IN RED POLYETHYLENE

**-35°C / +70°C**  
**-31°F / +158°F**



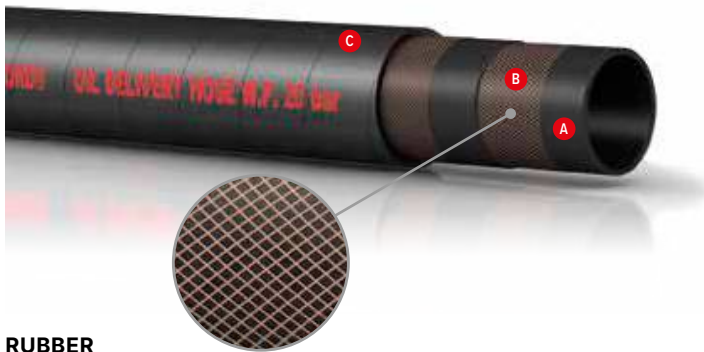

**RUBBER**



- **Antiestático.**  
Antistatic.



**USO  
APPLICATIONS**

Para entrega y la aspiración ligera de aceites minerales, gasóleo, gasolina y carburantes. Su particular estructura está diseñada para ser enrollada en bobinas para la carga y descarga de carburantes de camiones cisterna. Estructura resistente al aplastamiento y a la ovalización.

For the delivery and light suction of petroleum products from tanker vehicles. Can be wound on reels. Excellent resistance to crushing.



**ESTRUCTURA  
BODY**

<b>A</b> <b>Capa interior Tube</b>	Lisa en caucho NBR de color negro resistente a carburantes con un contenido de aromáticos de hasta el 50%. Smooth black NBR rubber, resistant to oil and petrol with aromatic content up to 50%.
<b>B</b> <b>Refuerzos Reinforcement</b>	Fibras sintéticas de alta resistencia e hilo de cobre incorporado para garantizar la disipación de la electricidad estática. High tensile synthetic textile and antistatic copper wire.
<b>C</b> <b>Capa exterior Cover</b>	Caucho negro PVC/NBR resistente a la abrasión, aceites, óleo y carburantes, agentes atmosféricos, ozono. Smooth black PVC/nbr rubber resistant to oils, petrol, abrasion, ozone and weather conditions.
<b>Superficie Surface</b>	Lisa con impresión de tela. Smooth with fabric impression.



**ABRAZADERAS Y COLLARES DE APRIETE  
RECOMENDADOS  
RECOMMENDED CLAMP/COLLAR**

STF - Abrazaderas de tornillo Hose clamps with screw (pag. 204-207)  
STC - Abrazaderas con perno Hose clamps with bolt (pag. 208-210)



mm	mm	bar	bar	bar	gr/mt	mm	m
19	32	20	60	-	668	190	40
25	38	20	60	-	804	254	40
32	45	20	60	-	1008	320	40
38	52,5	20	60	-	1282	380	40
40	54,5	20	60	-	1338	400	40
45	58	20	60	-	1416	445	40
50	64,5	20	60	-	1535	508	40



**NORMAS** NORMS:  
ISO 1307  
**MARCADOR** MARKING:  
EUROCORD® OIL DELIVERY HOSE W.P. 20 BAR  
**EMBALAJE** BOX:  
EMBALAJE EN POLIETILENO ROJO  
PACKAGING IN RED POLYETHYLENE



**-20°C / +70°C**  
**-4°F / +158°F**



**RUBBER**



- **Conforme con la norma EN 1360 Tipo 1. EN1360 type 1 approved.**

**USO APPLICATIONS**

Específica para dispensar carburantes en gasolineras (gasolina, gasolina verde y gasóleo).

For all types of gasoline dispensing applications. (Regular, premium gasoline and diesel).



**ESTRUCTURA BODY**

<b>A</b> Capa interior Tube	Caucho nitrílico negro, resistente a los productos derivados del petróleo. Oil, gasoline and diesel resistant smooth, black, nitrile rubber.
<b>B</b> Refuerzos Reinforcement	Refuerzo textil de alta tenacidad. e cordicella di rame antistatica. High tensile synthetic textile and antistatic copper wire.
<b>C</b> Capa exterior Cover	Caucho especial resistente al aceite, la llama, el ozono, la abrasión y los agentes atmosféricos. Flame, oil, fuel, abrasion, ozone, heat and weather resistant, synthetic rubber.
Superficie Surface	Lisa. Smooth.

mm	mm	bar	bar	bar	gr/mt	mm	m
12,7	21,5	16	48	-	295	50	>6
16	26	16	48	-	425	70	>6
19	29	16	48	-	475	95	>6
25,4	36,5	16	48	-	690	130	>6

<p><b>NORMAS NORMS:</b> EN 1360 TYPE 1 - ISO 1307</p> <p><b>MARCADOR MARKING:</b> EUROCORD® CARBO STATION EN 1360 TYPE - 1</p> <p><b>EMBALAJE BOX:</b> EMBALAJE EN POLIETILENO ROJO PACKAGING IN RED POLYETHYLENE</p>	<p><b>-30°C / +55°C</b> <b>-22°F / +158°F</b></p>

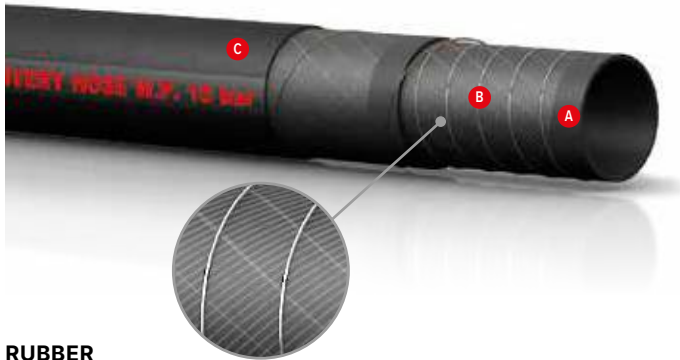

**RUBBER**



**USO APPLICATIONS**

Adecuada para entrega y la aspiración de aceites minerales, gasóleo, gasolina y carburantes. Especialmente adecuada para la descarga y carga de camiones cisterna, en gasolineras y refinerías.

Suitable for the mineral oils, diesel fuels, and fuels in general suction and delivery. Particularly used for the unloading and loading of tankers.



**ESTRUCTURA BODY**









<b>A</b> Capa interior Tube	Caucho NBR de color negro, resistente al carburante, con un contenido aromático no superior al 50%. Oil and petrol resistant, black NBR.
<b>B</b> Refuerzos Reinforcement	Espiral metálica incorporada con refuerzos textiles sintéticos e hilo de cobre para garantizar la disipación de la electricidad estática. High tensile synthetic textile, steel wire helix and antistatic copper wire.
<b>C</b> Capa exterior Cover	Caucho NBR/SBR resistente a los combustibles, al ozono y a los agentes atmosféricos. Oil, weather, ozone, abrasion resistant special synthetic rubber.
Superficie Surface	Lisa con impresión de tela. Smooth with fabric impression.



**ABRAZADERAS Y COLLARES DE APRIETE RECOMENDADOS RECOMMENDED CLAMP/COLLAR**

STF - Abrazaderas de tornillo Hose clamps with screw (pag. 204-207)  
STC - Abrazaderas con perno Hose clamps with bolt (pag. 208-210)



 mm	 mm	 bar	 bar	 bar	 gr/mt	 mm	 m
19	29	10	30	0,8	540	75	40
25	36	10	30	0,8	710	100	40
30	41	10	30	0,8	871	120	40
32	44	10	30	0,8	1014	130	40
35	46	10	30	0,8	993	140	40
38	49	10	30	0,8	1070	150	40
40	52	10	30	0,8	1249	160	40
45	57	10	30	0,8	1522	190	40
48	58	10	30	0,8	1314	200	40
51	63	10	30	0,8	1752	250	40
60	73	10	30	0,8	2132	310	40
70	83	10	30	0,8	2605	400	40
80	94	10	30	0,8	2983	475	20-40
90	104	10	30	0,8	3326	522	20
98	104	10	30	0,8	3326	522	20
100	117	10	30	0,8	4133	610	20-40
120	138	10	30	0,8	7400	720	20



**NORMAS** NORMS: ISO 1307  
**MARCADOR** MARKING: EUROCORDER® OIL SUCTION DELIVERY HOSE W.P. 10 BAR  
**EMBALAJE** BOX: EMBALAJE EN POLIETILENO ROJO PACKAGING IN RED POLYETHYLENE



**-35°C / +70°C**  
**-31°F / +158°F**

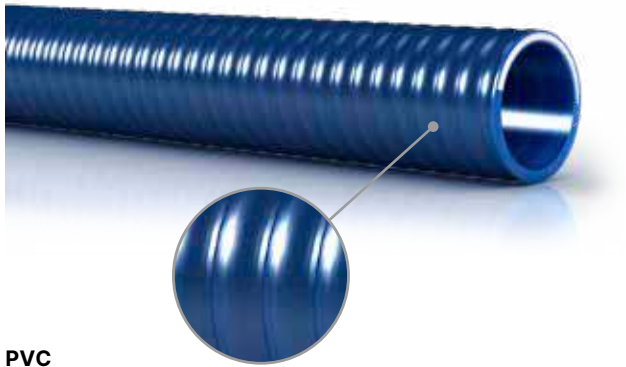

**PVC**



**USO  
APPLICATIONS**

Adecuada para la aspiración y entrega de productos petrolíferos. Su estructura especial la rinde muy resistente en condiciones de trabajo extremas (por ejemplo, purgas industriales). Se puede enrollar fácilmente en carretes.

For medium duty suction and delivery of industrial oils and fuels for use in cold climates. Crushing, chemical agents, abrasion and weather resistant.



**ESTRUCTURA  
BODY**

<b>A</b>	<b>Capa interior</b> Tube	Mezcla especial en PVC resistente al aceite y al carburante. Strong, flexible and smooth oil resistant PVC/nbr compound.
<b>B</b>	<b>Refuerzos</b> Reinforcement	Espiral en PVC antiplastamiento. Anti crushing PVC spiral.
<b>C</b>	<b>Capa exterior</b> Cover	En PVC ligeramente corrugado. Light corrugated outside.
	<b>Superficie</b> Surface	Azul oscuro. Blue matt.



**ABRAZADERAS Y COLLARES DE APRIETE  
RECOMENDADOS  
RECOMMENDED CLAMP/COLLAR**

STC - Abrazaderas con perno Hose clamps with bolt (pag. 208-210)  
BANDI BLOCK - Par de apriete Tightening torque (pag. 221)



mm	mm	bar	bar	bar	gr/mt	mm	m
20	4,6	8	-	0,8	450	80	50
25	4,6	8	-	0,8	580	100	50
30	4,8	8	-	0,8	650	120	50
32	4,8	8	-	0,8	670	128	50
35	5	7	-	0,8	720	140	50
38	5	7	-	0,8	770	152	50
40	5	7	-	0,8	815	160	50
45	5,1	7	-	0,8	960	180	50
50	5,6	7	-	0,8	1150	200	50
60	5,9	6	-	0,8	1530	240	50
63	6	6	-	0,8	1580	252	50
70	6,1	6	-	0,8	1820	280	50
75	6,2	5	-	0,8	1920	300	50
80	6,4	4	-	0,8	2100	320	50/30
90	6,6	4	-	0,8	2400	360	30/25
100	7,2	3	-	0,8	3200	400	30/25
120	7,9	3	-	0,7	3800	480	30/25
152	9,8	2,5	-	0,7	6150	608	30/25



NORMAS NORMS:  
ISO 1307



-25°C / +60°C  
-13°F / +140°F



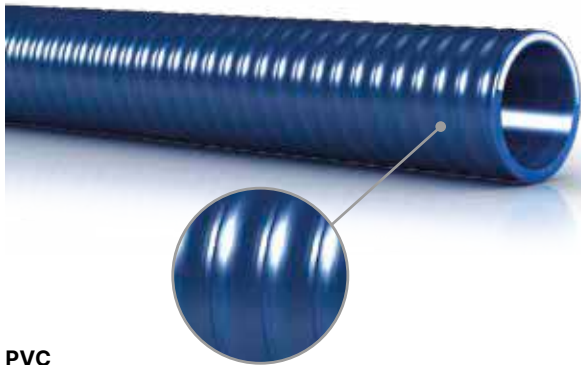

PVC



- **Antiestático.**  
Antistatic.



**USO  
APPLICATIONS**









Adecuada para la aspiración y entrega de productos petrolíferos. Su estructura especial la rinde muy resistente en condiciones de trabajo extremas (por ejemplo, purgas industriales). Se puede enrollar fácilmente en carretes.

For industrial oils and fuel suction and delivery. Its particularly structure makes it resistant to extreme working conditions. it is easy to roll up it on reels.



**ESTRUCTURA  
BODY**

<b>A</b> Capa interior Tube	Mezcla especial en PVC resistente al aceite y al carburante. Strong, flexible and smooth oil resistant PVC/nbr compound.
<b>B</b> Refuerzos Reinforcement	Espiral en PVC antiplastamiento e hilo de cobre para la disipación de la electricidad estática. Anti crushing PVC spiral and longitudinal copper wire.
<b>C</b> Capa exterior Cover	En PVC ligeramente corrugado. Light corrugated outside.
Superficie Surface	Azul oscuro. Blue matt.

 mm	 mm	 bar	 bar	 bar	 gr/mt	 mm	 m
20	4,6	8	-	0,8	450	80	50
25	4,6	8	-	0,8	580	100	50
30	4,8	8	-	0,8	650	120	50
32	4,8	8	-	0,8	670	128	50
35	5	7	-	0,8	720	140	50
38	5	7	-	0,8	770	152	50
40	5	7	-	0,8	815	160	50
45	5,1	7	-	0,8	960	180	50
50	5,6	7	-	0,8	1150	200	50
60	5,9	6	-	0,8	1530	240	50
63	6	6	-	0,8	1580	252	50
70	6,1	6	-	0,8	1820	280	50
75	6,2	5	-	0,8	1920	300	50
80	6,4	4	-	0,8	2100	320	50
90	6,6	4	-	0,8	2400	360	25
100	7,2	3	-	0,8	3200	400	25
120	7,9	3	-	0,7	3800	480	25
152	9,8	2,5	-	0,7	6150	608	25



**ABRAZADERAS Y COLLARES DE APRIETE  
RECOMENDADOS  
RECOMMENDED CLAMP/COLLAR**

STC - Abrazaderas con perno Hose clamps with bolt (pag. 208-210)  
BANDI BLOCK - Par de apriete Tightening torque (pag. 221)



NORMAS NORMS:  
ISO 1307



**-25°C / +60°C**  
**-13°F / +140°F**

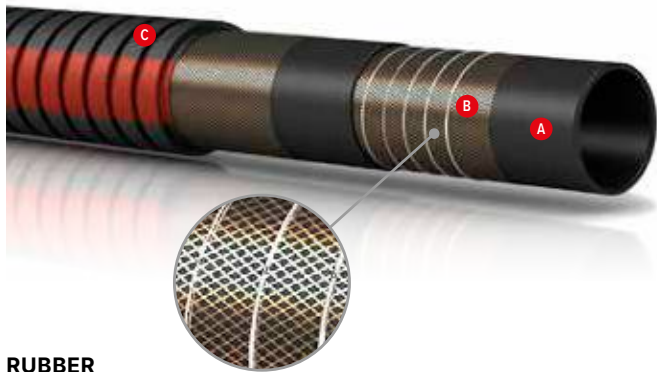

RUBBER



- **Ideal para el sector automovilístico y vehículos industriales.**  
**Ideal for the automotive sector and for the industrial vehicles.**

**USO APPLICATIONS**

Para la aspiración y entrega de aceites parafínicos, aire, agua y glicol. Especialmente adecuada para aplicaciones en las que se requieren pequeños radios de curvatura; se utiliza ampliamente en los sectores automovilístico y los vehículos industriales como manguera polivalente.

For paraffinic oils, air, water and glycol suction and delivery. Particularly used where it is necessary a small band radius. Suitable for the automotive sector and for the industrial vehicles.



**ESTRUCTURA BODY**

<b>A</b> Capa interior Tube	Caucho NBR negro resistente a aceites, óleo y carburantes, contenido aromático no superior al 50%. Oil and petrol resistant, black NBR, with aromatic content up to 50%.
<b>B</b> Refuerzos Reinforcement	Textiles sintéticos de alta tenacidad y espiral metálica incorporada, hilo de cobre. High tensile synthetic textile, steel wire helix and antistatic copper wire.
<b>C</b> Capa exterior Cover	Caucho EPDM. Oil, weather, ozone, abrasion resistant special synthetic rubber.
Superficie Surface	Acanalada en impresión en tela. Greccato with fabric impression.

mm	mm	bar	bar	bar	gr/mt	mm	m
19	29	10	30	0,8	540	75	40
25	36	10	30	0,8	710	100	40
30	41	10	30	0,8	871	120	40
32	44	10	30	0,8	1014	130	40
35	46	10	30	0,8	993	140	40
38	49	10	30	0,8	1070	150	40
40	52	10	30	0,8	1249	160	40
45	57	10	30	0,8	1522	190	40
48	58	10	30	0,8	1314	200	40
51	63	10	30	0,8	1752	250	40
60	73	10	30	0,8	2132	310	40
70	83	10	30	0,8	2605	400	40
80	94	10	30	0,8	2983	475	20-40
90	104	10	30	0,8	3326	522	20
98	104	10	30	0,8	3326	522	20
100	117	10	30	0,8	4133	610	20-40
120	138	10	30	0,8	7400	720	20

**ABRAZADERAS Y COLLARES DE APRIETE RECOMENDADOS**  
**RECOMMENDED CLAMP/COLLAR**

- STF - Abrazaderas de tornillo Hose clamps with screw (pag. 204-207)
- SDB - Abrazaderas de tensión constante SAE Constant tension clamps SAE (pag. 215)
- STC - Abrazaderas con perno Hose clamps with bolt (pag. 208-210)
- STS - Abrazaderas de tensión constante SAE Constant tension clamps SAE (pag. 214)



**NORMAS NORMS:**  
ISO 1307

**MARCADOR MARKING:**  
EUROCORD® OIL SUCTION DELIVERY HOSE W.P. 10 BAR

**EMBALAJE BOX:**  
EMBALAJE EN POLIETILENO NEGRO  
PACKAGING IN BLACK POLYETHYLENE



**-35°C / +100°C**  
**-31°F / +212°F**

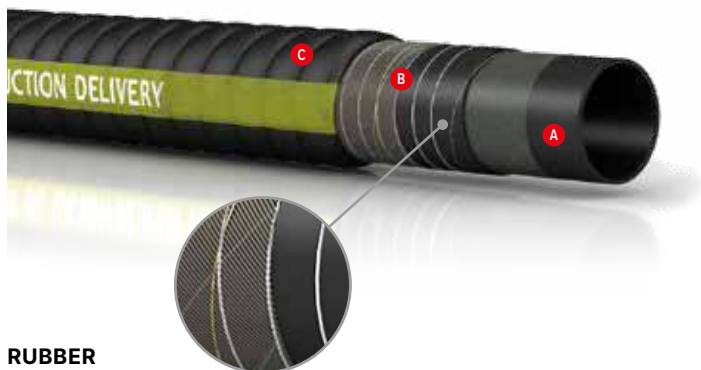

**RUBBER**



**USO  
APPLICATIONS**

Adecuada para entrega y la aspiración de aceites minerales, gasóleo, gasolina y carburantes. Especialmente adecuada para la descarga y carga de camiones cisterna, en gasolineras y refinerías.

Suitable for the mineral oils, diesel fuels, and fuels in general suction and delivery. Particularly used for the unloading and loading of gas stations.



**ESTRUCTURA  
BODY**









<b>A</b> <b>Capa interior Tube</b>	Caucho NBR de color negro, resistente al carburante, con un contenido aromático no superior al 50%. Synthetic NBR oil and petrol resistant for aromatic content up to 50%.
<b>B</b> <b>Refuerzos Reinforcement</b>	Espiral metálica incorporada con refuerzos textiles sintéticos e hilo de cobre para garantizar la disipación de la electricidad estática. High tensile synthetic textile, steel wire helix and antistatic copper wire.
<b>C</b> <b>Capa exterior Cover</b>	Caucho NBR/SBR resistente a los combustibles, al ozono y a los agentes atmosféricos. Oil, weather, ozone, abrasion resistant, corrugated special synthetic rubber.
<b>Superficie Surface</b>	Corrugada en impresión en tela. Corrugated with fabric impression.



**ABRAZADERAS Y COLLARES DE APRIETE  
RECOMENDADOS  
RECOMMENDED CLAMP/COLLAR**

STC - Abrazaderas con perno Hose clamps with bolt (pag. 208-210)



 mm	 mm	 bar	 bar	 bar	 gr/mt	 mm	 m
40	51	5	15	0,5	1076	160	40
45	56	5	15	0,5	1195	180	40
50	61	5	15	0,5	1344	200	40
50	64	5	15	0,5	1764	220	40
80	94	5	15	0,5	2615	320	20
102	116	5	15	0,5	3439	400	20



**NORMAS** NORMS:  
ISO 1307  
**MARCADOR** MARKING:  
EUROCORD® OIL SUCTION DELIVERY  
**EMBALAJE** BOX:  
EMBALAJE EN POLIETILENO ROJO  
PACKAGING IN RED POLYETHYLENE



**-35°C / +70°C**  
**-31°F / +158°F**

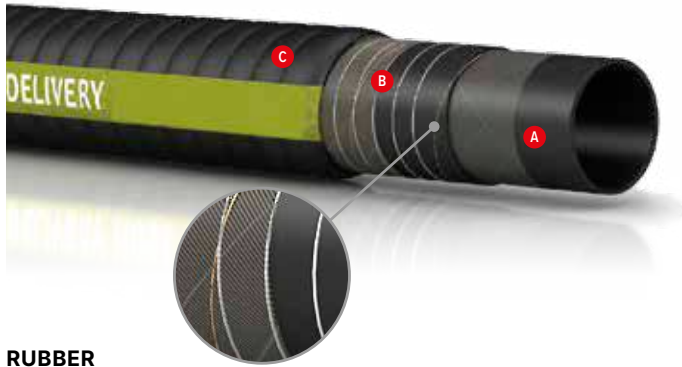

**RUBBER**

- **Se suministra con manguitos flexibles en los extremos para facilitar la conexión.**  
Provided with soft cuffs-ends.
- **Disponible en longitudes de aplicación.**  
Available in different sizes.

**USO APPLICATIONS**

Adecuada para entrega y la aspiración de aceites minerales, gasóleo, gasolina y carburantes. Especialmente adecuada para la descarga y carga de camiones cisterna, en gasolineras y refinerías. La manguera se suministra con manguitos flexibles en el extremo para facilitar la conexión con abrazadera.

Suitable for the mineral oils, diesel fuels, and fuels in general suction and delivery. Particularly used for the unloading and loading of gas stations.



**ESTRUCTURA BODY**

<b>A</b> Capa interior Tube	Caucho NBR de color negro, resistente al carburante, con un contenido aromático no superior al 50%. Synthetic NBR oil and petrol resistant for aromatic content up to 50%.
<b>B</b> Refuerzos Reinforcement	Espiral metálica incorporada con refuerzos textiles sintéticos e hilo de cobre para garantizar la disipación de la electricidad estática. High tensile synthetic textile, steel wire helix and antistatic copper wire.
<b>C</b> Capa exterior Cover	Caucho NBR/SBR resistente a los combustibles, al ozono y a los agentes atmosféricos. Oil, weather, ozone, abrasion resistant, corrugated special synthetic rubber.
Superficie Surface	Corrugada en impresión en tela. Corrugated with fabric impression.

40	51	5	15	0,5	1076	160	2-3-4
50	62	5	15	0,5	1744	200	2-3-4
80	93	5	15	0,5	2582	320	2-3-4
102	116	5	15	0,5	3335	400	2-3-4

**ABRAZADERAS Y COLLARES DE APRIETE RECOMENDADOS**  
**RECOMMENDED CLAMP/COLLAR**

STC - Abrazaderas con perno Hose clamps with bolt (pag. 208-210)



<p><b>NORMAS NORMS:</b> ISO 1307</p> <p><b>MARCADOR MARKING:</b> EUROCORD® OIL SUCTION DELIVERY</p> <p><b>EMBALAJE BOX:</b> EMBALAJE EN POLIETILENO ROJO PACKAGING IN RED POLYETHYLENE</p>	<p><b>-35°C / +70°C</b> <b>-31°F / +158°F</b></p>
--	---



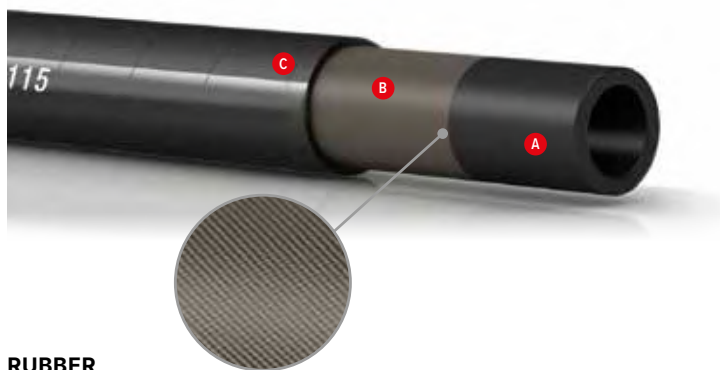

### RUBBER



#### USO APPLICATIONS

Adecuada para la aspiración y entrega de productos petrolíferos con un contenido aromático de hasta el 50%.

For discharge of petroleum products with aromatic content up to 50%.



#### ESTRUCTURA BODY

<b>A</b>	<b>Capa interior Tube</b>	Caucho NBR de color negro, conductor, resistente a los productos derivados del petróleo. Oil and petrol resistant, conductive NBR.
<b>B</b>	<b>Refuerzos Reinforcement</b>	Textiles de alta tenacidad e hilo de cobre antiestático. High tensile synthetic textile, antistatic copper wire.
<b>C</b>	<b>Capa exterior Cover</b>	Caucho sintético especial, resistente al aceite, la llama, el ozono, la abrasión, los agentes atmosféricos y el agua de mar. Oil, weather, ozone, abrasion and flame resistant, special synthetic rubber.
	<b>Superficie Surface</b>	Lisa con impresión de tela. Smooth with fabric impression.



#### ABRAZADERAS Y COLLARES DE APRIETE RECOMENDADOS RECOMMENDED CLAMP/COLLAR

STF - Abrazaderas de tornillo Hose clamps with screw (pag. 204-207)



mm	mm	bar	bar	bar	gr/mt	mm	m
19	31	16	64	-	673	125	40
25,4	37	16	64	-	842	150	40
32	44	16	64	-	1037	175	40
38	51	16	64	-	1408	225	40
50,8	67	16	64	-	2205	275	40
63,5	79	16	64	-	2739	300	40
76,2	92	16	64	-	3304	350	40
101,6	118	16	64	-	4542	450	40



**NORMAS** NORMS:  
EN 12115  
**MARCADOR** MARKING:  
EUROCORD® TANK TRUCK HD EN 12115

**EMBALAJE** BOX:  
EMBALAJE EN POLIETILENO TRANSPARENTE  
PACKAGING IN TRANSPARENT POLYETHYLENE



**20°C / +70°C**  
**-4°F / +158°F**



RUBBER

### USO APPLICATIONS

Adecuada para la aspiración y entrega de productos petrolíferos con un contenido aromático de hasta el 50%.

For discharge of petroleum products with aromatic content up to 50%.



### ESTRUCTURA BODY

<b>A</b> Capa interior Tube	Caucho NBR de color negro, conductor, resistente a los productos derivados del petróleo. Oil and petrol resistant, conductive NBR.
<b>B</b> Refuerzos Reinforcement	Textiles de alta tenacidad con espiral de acero y dos hilos de cobre antiestáticos. High tensile synthetic textile, antistatic copper wire.
<b>C</b> Capa exterior Cover	Caucho sintético especial, resistente al aceite, la llama, el ozono, la abrasión, los agentes atmosféricos y el agua de mar. Oil, weather, ozone, abrasion and flame resistant, special synthetic rubber.
Superficie Surface	Lisa con impresión de tela. Smooth with fabric impression.

19	31	16	64	0,92	673	125	40
25,4	37	16	64	0,92	842	150	40
32	44	16	64	0,92	1037	175	40
38	51	16	64	0,92	1408	225	40
50,8	67	16	64	0,92	2205	275	40
63,5	79	16	64	0,92	2739	300	40
76,2	92	16	64	0,80	3304	350	40
101,6	118	16	64	0,80	4542	450	40

### ABRAZADERAS Y COLLARES DE APRIETE RECOMENDADOS RECOMMENDED CLAMP/COLLAR

STF - Abrazaderas de tornillo Hose clamps with screw (pag. 204-207)



**NORMAS NORMS:**  
EN 12115  
**MARCADOR MARKING:** EUROCORD® TANK TRUCK SP EN 12115  
**EMBALAJE BOX:**  
EMBALAJE EN POLIETILENO TRANSPARENTE  
PACKAGING IN TRANSPARENT POLYETHYLENE



**20°C / +70°C**  
**-4°F / +158°F**

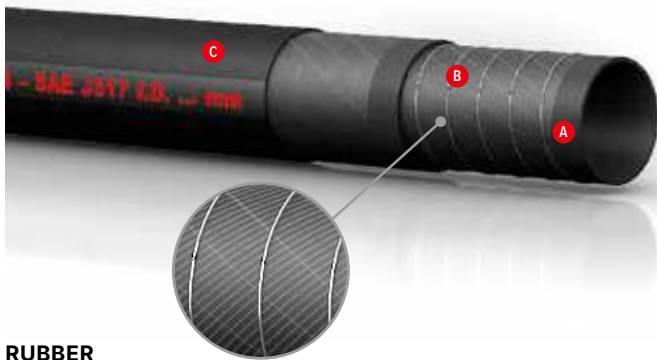

**RUBBER**



- **Ideal para los sectores hidráulico, agrícola e industrial.**  
Ideal for the oleodynamic, industrial and agricultural sectors.
- **Conforme con la norma SAE J517 100R4.**  
SAE J517 100R4 approved.



**USO  
APPLICATIONS**

Adecuada para entrega y la aspiración de aceites hidráulicos en sistemas hidráulicos. Especialmente utilizada en la agricultura y la industria; instalada y conectada a maquinaria agrícola, máquinas industriales, prensas, etc.

Suitable for hydraulic oils suction and delivery in hydraulic plants. Particularly used in agricultural and industrial sectors.



**ESTRUCTURA  
BODY**

<b>A</b>	<b>Capa interior Tube</b>	Caucho NBR negro resistente a los aceites hidráulicos. Oil and petrol resistant, conductive NBR.
<b>B</b>	<b>Refuerzos Reinforcement</b>	Espiral metálica con refuerzos textiles sintéticos e hilo de cobre. High tensile synthetic textile, antistatic copper wire.
<b>C</b>	<b>Capa exterior Cover</b>	Caucho NEOPRENO resistente al ozono, a los agentes atmosféricos y al carburante. Oil, weather, ozone, abrasion and Diesel resistant, special synthetic neoprene rubber.
	<b>Superficie Surface</b>	Lisa con impresión de tela. Smooth with fabric impression.



**ABRAZADERAS Y COLLARES DE APRIETE  
RECOMENDADOS  
RECOMMENDED CLAMP/COLLAR**

STF - Abrazaderas de tornillo Hose clamps with screw (pag. 204-207)  
STC - Abrazaderas con perno Hose clamps with bolt (pag. 208-210)



mm	mm	bar	bar	bar	gr/mt	mm	m
19	29	21	84	0,8	541	50	40
22	32	17	68	0,8	616	60	40
25,4	35	17	68	0,8	683	65	40
28	39	17	68	0,8	834	78	40
30	41	17	68	0,8	866	82	40
32	42	14	56	0,8	848	85	40
35	46	14	56	0,8	1021	90	40
38	49	10	40	0,8	1202	95	40
40	52	10	40	0,8	1256	100	40
42	54	10	40	0,8	1455	110	40
45	57	10	40	0,8	1555	110	40
50,8	62	7	28	0,8	1525	135	40
60	72	4	16	0,8	2009	175	40
63,5	75,5	4	16	0,8	2277	180	40
70	84	4	16	0,8	2725	240	40
76,2	88	4	16	0,8	2618	225	40
80	94	4	16	0,8	2950	240	20
90	103	3	12	0,8	3291	270	20-40
101,6	115	2	8	0,8	3775	400	20-40



**NORMAS NORMS:**  
ISO 1307  
**MARCADOR MARKING:**  
EUROCORD® SAE 100 R4 - SAE J517 I. D. A.MM  
**EMBALAJE BOX:**  
EMBALAJE EN POLIETILENO ROJO  
PACKAGING IN RED POLYETHYLENE



**-40°C / +100°C**  
**-40°F / +212°F**

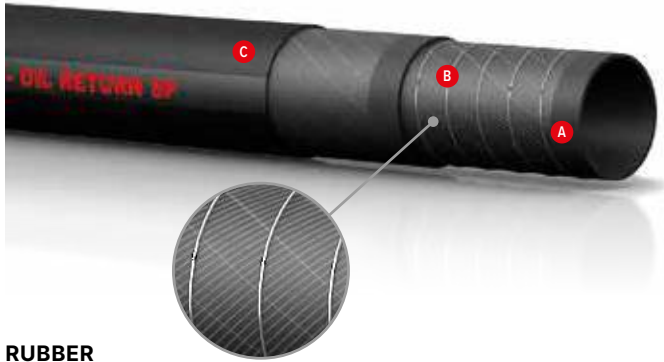

**RUBBER**



- **Ideal para los sectores hidráulico, agrícola e industrial.**  
Ideal for the oleodynamic, industrial and agricultural sectors.

**USO APPLICATIONS**

Adecuada para entrega y la aspiración de aceites hidráulicos en sistemas hidráulicos. Especialmente utilizada en la agricultura y la industria; instalada y conectada a maquinaria agrícola, máquinas industriales, prensas, etc.

Suitable for hydraulic oils suction and delivery in hydraulic plants. Particularly used in agricultural and industrial sectors.



**ESTRUCTURA BODY**

<b>A</b> Capa interior Tube	Caucho NBR/SBR resistente a los aceites hidráulicos. Hydraulic oil resistant special synthetic rubber.
<b>B</b> Refuerzos Reinforcement	Espiral metálica con refuerzos textiles sintéticos. High tensile synthetic textile and steel wire helix.
<b>C</b> Capa exterior Cover	Caucho SBR resistente al ozono y a los agentes atmosféricos. Oil, heat, abrasion, ozone and weather resistant special synthetic rubber.
Superficie Surface	Lisa con impresión de tela. Smooth with fabric impression.

mm	mm	bar	bar	bar	gr/mt	mm	m
19	-	10	30	0,8	555	75	61
25	-	10	30	0,8	726	100	61
30	-	10	30	0,8	824	120	61
32	-	10	30	0,8	941	150	61
35	-	10	30	0,8	1004	170	61
38	-	10	30	0,8	1169	180	61
42	-	10	30	0,8	1254	190	61
51	-	10	30	0,8	1806	250	61
60	-	10	30	0,8	2050	300	61

**ABRAZADERAS Y COLLARES DE APRIETE RECOMENDADOS RECOMMENDED CLAMP/COLLAR**

- STF - Abrazaderas de tornillo Hose clamps with screw (pag. 204-207)
- STC - Abrazaderas con perno Hose clamps with bolt (pag. 208-210)



**NORMAS NORMS:**  
ISO 1307

**MARCADOR MARKING:**  
EUROCORD® TYPE SAE 100R4 - OIL RETURN SP

**EMBALAJE BOX:**  
EMBALAJE EN POLIETILENO ROJO  
PACKAGING IN RED POLYETHYLENE

**-40°C / +100°C**  
**-40°F / +212°F**



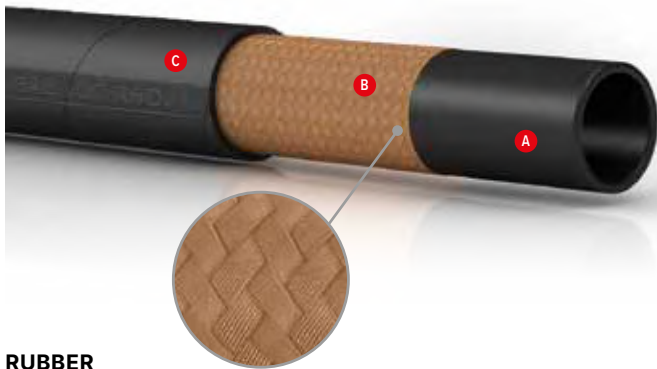

**RUBBER**



- **Conforme con las normas SAE J517 100R6 EN 854 tipo R6. SAE J517 100R6 approved.**



**USO APPLICATIONS**

Adecuada para entrega de fluidos hidráulicos, aceites minerales, lubricantes y carburante diésel. Conforme con las normas SAE J517 100R6 EN 854 tipo R6.

Suitable to the hydraulic fluids, mineral oils, lubricants and diesel fuels delivery. SAE J517 100R6 EN854 type R6 approved.



**ESTRUCTURA BODY**

<b>A</b>	<b>Capa interior Tube</b>	Lisa en caucho NBR de color negro. Oil and petrol resistant, conductive NBR.
<b>B</b>	<b>Refuerzos Reinforcement</b>	1 trenza de hilo sintético de alta resistencia. 1 high tensile synthetic textile, antistatic copper wire.
<b>C</b>	<b>Capa exterior Cover</b>	Caucho NEOPRENO resistente al ozono, a los agentes atmosféricos y al carburante. Oil, weather, ozone, abrasion and Diesel resistant, special synthetic neoprene rubber.
	<b>Superficie Surface</b>	Lisa con impresión de tela. Smooth with fabric impression.

mm	inch	mm	bar	bar	bar	gr/mt	mm	m
4,8	3/16	11,9	34	-	-	99	50	10-100
6,4	1/4	13,5	28	-	-	100	65	10-100
7,9	5/16	15,1	28	-	-	125	75	10-100
9,5	3/8	16,7	28	-	-	150	75	10-100
12,7	1/2	20,6	28	-	-	200	100	10-100
15,9	5/8	23,8	24	-	-	250	125	10-100
19	3/4	27,8	21	-	-	300	150	10-100
25,4	1	33,4	12	-	-	450	135	10-100



**NORMAS** NORMS:  
SAE J517 100 R6 - EN 854 TYPE R6 - ISO 1307

**MARCADOR** MARKING:  
EUROCORD® EN 854 - SAE 100 R 6 -DIAMETER-  
PRODUCTION QUARTER

**EMBALAJE** BOX:  
EMBALAJE EN POLIETILENO ROJO  
PACKAGING IN RED POLYETHYLENE



**-40°C / +100°C**  
**-40°F / +212°F**

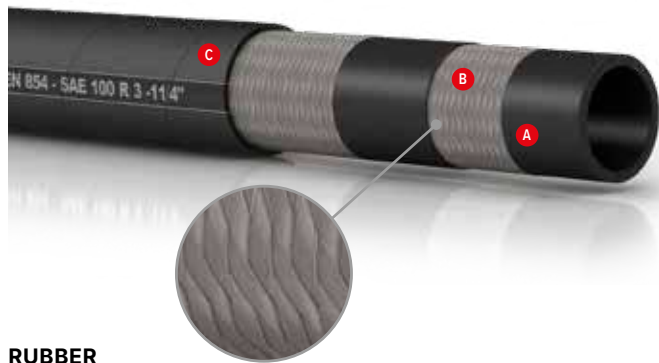

**RUBBER**



- **Conforme con las normas SAE J517 100R3 EN 854 tipo R3.**  
SAE J517 100R3 EN 854 approved.

**USO APPLICATIONS**

Adecuada para entrega de fluidos hidráulicos, aceites minerales, lubricantes y carburante diésel. Conforme con las normas SAE J517 100R3 EN 854 tipo R3

Suitable to the hydraulic fluids, mineral oils, lubricants and diesel fuels delivery. SAE J517 100R3 EN854 type R3 approved.



**ESTRUCTURA BODY**

<b>A</b>	<b>Capa interior Tube</b>	Lisa en caucho NBR de color negro. Oil and petrol resistant, conductive NBR.
<b>B</b>	<b>Refuerzos Reinforcement</b>	2 trenzas de hilos sintéticos de alta resistencia. 2 high tensile synthetic textile, antistatic copper wire.
<b>C</b>	<b>Capa exterior Cover</b>	Caucho CR resistente a los agentes atmosféricos, la abrasión, los aceites, óleo y carburantes. Oil, abrasion, ozone and weather resistant black synthetic rubber.
	<b>Superficie Surface</b>	Lisa con impresión de tela. Smooth with fabric impression.

mm	inch	mm	bar	bar	bar	gr/mt	mm	m
4,8	3/16	12,7	-	-	-	160	60	10-100
6,4	1/4	14,3	-	-	-	180	80	10-100
7,9	5/16	17,5	-	-	-	265	100	10-100
9,5	3/8	19,1	-	-	-	295	100	10-100
12,7	1/2	23,7	-	-	-	425	125	10-100
15,9	5/8	27	-	-	-	500	140	10-100
19	3/4	31,8	-	-	-	700	150	10-100
25,4	1	38,1	-	-	-	845	205	10-100
31,8	1 1/4	44,5	-	-	-	990	255	10-100

**NORMAS NORMS:**  
SAE J517 100 R3 - EN 854 TYPE R3 - ISO 1307

**MARCADOR MARKING:**  
EUROCORD® EN 854 - SAE 100 R 3 - DIAMETER-  
PRODUCTION QUARTER

**EMBALAJE BOX:**  
EMBALAJE EN POLIETILENO ROJO  
PACKAGING IN RED POLYETHYLENE

**-40°C / +100°C**  
**-40°F / +212°F**

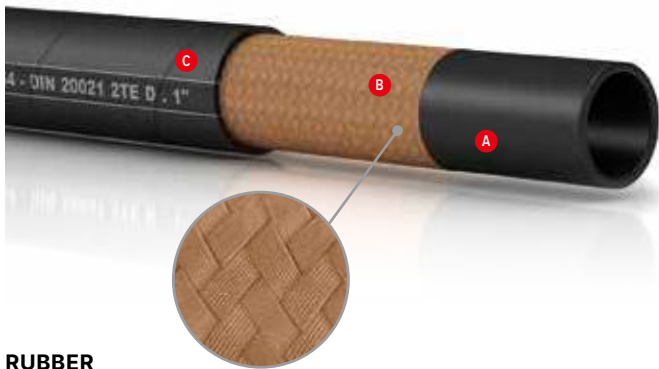

RUBBER



- **Conforme con las normas EN 854 DIN 20021.**  
EN 854 DIN 20021 approved.



### USO APPLICATIONS

Adecuada para entrega de fluidos hidráulicos, aceites minerales, lubricantes y carburante diésel. Conforme con las normas EN 854 DIN 20021.

For hydraulic control lines, discharge under low pressure of hydraulic fluids, fuel oil, grease, air and water.  
EN 854 DIN 20021 approved.



### ESTRUCTURA BODY

<b>A</b> <b>Capa interior Tube</b>	Lisa en caucho CR especial resistente a los aceites hidráulicos. Hydraulic Oil resistant special synthetic rubber.
<b>B</b> <b>Refuerzos Reinforcement</b>	1 trenza textil de alta tenacidad. 1 high tensile synthetic textile braid.
<b>C</b> <b>Capa exterior Cover</b>	Caucho CR resistente a los agentes atmosféricos, la abrasión, los aceites, óleo y carburantes. Oil, abrasion, ozone and weather resistant special synthetic rubber.
<b>Superficie Surface</b>	Lisa con impresión de tela. Smooth with fabric impression.

mm	inch	mm	bar	bar	bar	gr/mt	mm	m
4,8	3/16	11,8	80	320	-	114	25	10-80
6,4	1/4	13,4	75	300	-	144	40	10-80
7,9	5/16	14,9	68	272	-	165	50	10-80
9,5	3/8	16,5	63	252	-	185	60	10-80
12,7	1/2	19,8	58	232	-	237	70	10-80
15,9	5/8	23,9	50	200	-	322	90	10-80
19	3/4	27	45	180	-	382	110	10-80
25,4	1	34,4	40	160	-	557	150	10-80



**NORMAS NORMS:**  
EN 854 TYPE 2TE - DIN 20021 2TE - ISO 4079-1  
2TE - ISO 1307

**MARCADOR MARKING:**  
EUROCORD® EN 854 - DIN 20021 2TE (DIAM. INCH)

**EMBALAJE BOX:**  
EMBALAJE EN POLIETILENO ROJO  
PACKAGING IN RED POLYETHYLENE



**-40°C / +100°C**  
**-40°F / +212°F**

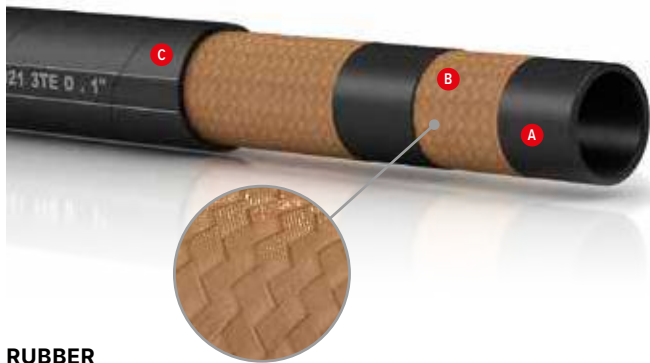

**RUBBER**



- **Conforme con las normas EN 854 DIN 20021.**  
**EN 854 DIN 20021 approved.**

**USO APPLICATIONS**

Adecuada para entrega de fluidos hidráulicos, aceites minerales, lubricantes y carburante diésel. Conforme con las normas EN 854 DIN 20021.

For hydraulic control lines, discharge under low pressure of hydraulic fluids, fuel oil, grease, air and water.  
EN 854 DIN 20021 approved.



**ESTRUCTURA BODY**

<b>A</b> <b>Capa interior Tube</b>	Lisa en caucho CR especial resistente a los aceites hidráulicos. Hydraulic Oil resistant special synthetic rubber.
<b>B</b> <b>Refuerzos Reinforcement</b>	2 trenzas textiles de alta tenacidad. 2 high tensile synthetic textile braid.
<b>C</b> <b>Capa exterior Cover</b>	Caucho CR resistente a los agentes atmosféricos, la abrasión, los aceites, óleo y carburantes. Oil, abrasion, ozone and weather resistant special synthetic rubber.
<b>Superficie Surface</b>	Lisa con impresión de tela. Smooth with fabric impression.

mm	inch	mm	bar	bar	bar	gr/mt	mm	m
4,8	3/16	12,8	160	640	-	156	40	10-80
6,4	1/4	14,4	145	580	-	187	45	10-80
7,9	5/16	16,9	130	520	-	244	55	10-80
9,5	3/8	18,5	110	440	-	269	70	10-80
12,7	1/2	21,7	93	372	-	335	85	10-80
15,9	5/8	25,9	80	320	-	434	105	10-80
19	3/4	29	70	280	-	500	130	10-80
25,4	1	36	55	220	-	667	150	10-80
31,8	1 1/4	42,3	45	180	-	827	190	10-80
38,1	1 1/2	49,6	40	160	-	1048	240	10-80

**NORMAS NORMS:**  
EN 854 TYPE 3TE - DIN 20021 3TE - ISO 4079-1  
3TE - ISO 1307

**MARCADOR MARKING:**  
EUROCORD® EN 854 - DIN 20021 3TE (DIAM. INCH)

**EMBALAJE BOX:**  
EMBALAJE EN POLIETILENO ROJO  
PACKAGING IN RED POLYETHYLENE

**-40°C / +100°C**  
**-40°F / +212°F**



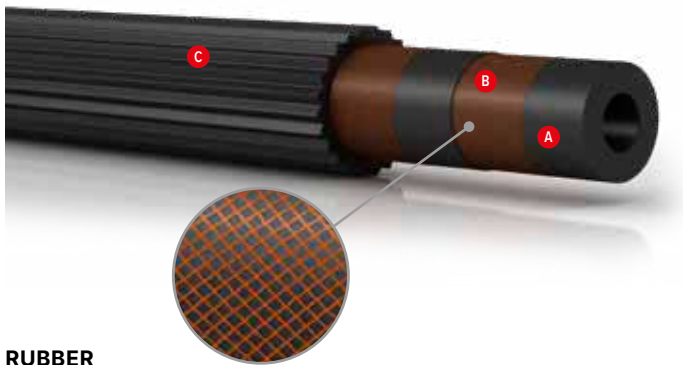

**RUBBER**



- **Conforme con las normas SAE J 1401.**  
SAE J 1401 approved.



**USO  
APPLICATIONS**

Adecuada para sistemas de frenos de automóviles y fluidos hidráulicos. Conforme con las normas SAE J 1401

Suitable for the hydraulic brake systems in the automotive sector. SAE J 1401 approved.



**ESTRUCTURA  
BODY**

<b>A</b> <b>Capa interior</b> Tube	Lisa en caucho NBR de color negro. Hydraulic brake fluid resistant special synthetic rubber.
<b>B</b> <b>Refuerzos</b> Reinforcement	Un trenzado textil de alta tenacidad. High tensile synthetic textile.
<b>C</b> <b>Capa exterior</b> Cover	Caucho CR resistente a los agentes atmosféricos, la abrasión, los aceites, óleo y carburantes. Abrasion, ozone and weather resistant special synthetic rubber.
<b>Superficie</b> Surface	Rallado. Braided.

mm	inch	mm	bar	bar	bar	gr/mt	mm	m
3,2	1/8	10,5	276	490	-	91	30	10-80
5	3/16	13	276	345	-	129	50	10-80



**NORMAS** NORMS:  
ISO 1307 - SAE J 1401  
**EMBALAJE** BOX:  
EMBALAJE EN POLIETILENO ROJO  
PACKAGING IN RED POLYETHYLENE



**-45°C / +80°C**  
**-49°F / +176°F**

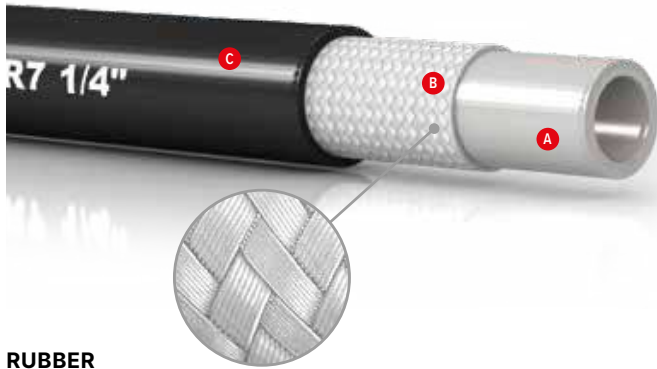

**RUBBER**



- **Conforme con las normas SAE J517 FEB98 100R7.**  
SAE J 517 FEB98 100R7 approved.
- **Manguera termoplástica adecuada para el sector náutico.**  
Thermoplastic hose suitable for the marine sector.

**USO APPLICATIONS**

Manguera termoplástica de alta presión para aplicaciones hidráulicas, especialmente indicada para el sector náutico.

Flexible and thermoplastic hose for high pressure used for hydraulic applications, particularly suitable in marine sector.

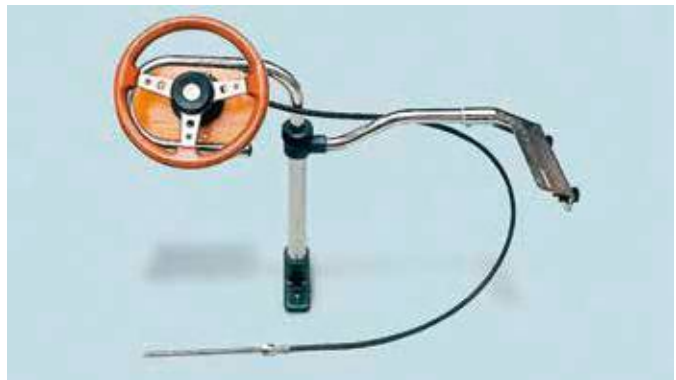

**ESTRUCTURA BODY**

<b>A</b> Capa interior Tube	Mezcla especial de poliéster sin color. Special polyester compound.
<b>B</b> Refuerzos Reinforcement	2 trenzas de fibra sintética de alta resistencia. 2 high resistant braids of synthetic fibers.
<b>C</b> Capa exterior Cover	Negro liso semibrillante microperforado en mezcla especial de poliuretano resistente al aceite, a la abrasión, a los agentes atmosféricos y al agua de mar, con marcador longitudinal en tinta blanca. Black smooth perforated. It has a special oil resistant and anti abrasion polyurethane compound.
Superficie Surface	Lisa. Smooth.

mm	inch	mm	bar	bar	bar	gr/mt	mm	m
5	3/16	9,3	220	880	-	60	26	10-80
6,6	1/4	12,5	215	860	-	100	30	10-80
8	5/16	14,3	195	780	-	140	40	10-80
9,7	3/8	16,5	187	750	-	170	70	10-80
13	1/2	20,5	157	630	-	230	90	10-80

**NORMAS NORMS:**  
EN 855:1996 R7  
ISO 3949:2004/R7-1 - SAE J517 FEB98 100R7

**MARCADOR MARKING:**  
EUROCORD® SAE 100 R7 1/4"

**EMBALAJE BOX:**  
EMBALAJE EN POLIETILENO TRANSPARENTE  
PACKAGING IN TRANSPARENT POLYETHYLENE

**-40°C / +100°C**  
**-40°F / +212°F**

# VAINAS Y ESPIRALES DE PROTECCIÓN

SPIRAL PROTECTION  
PVC HOSES

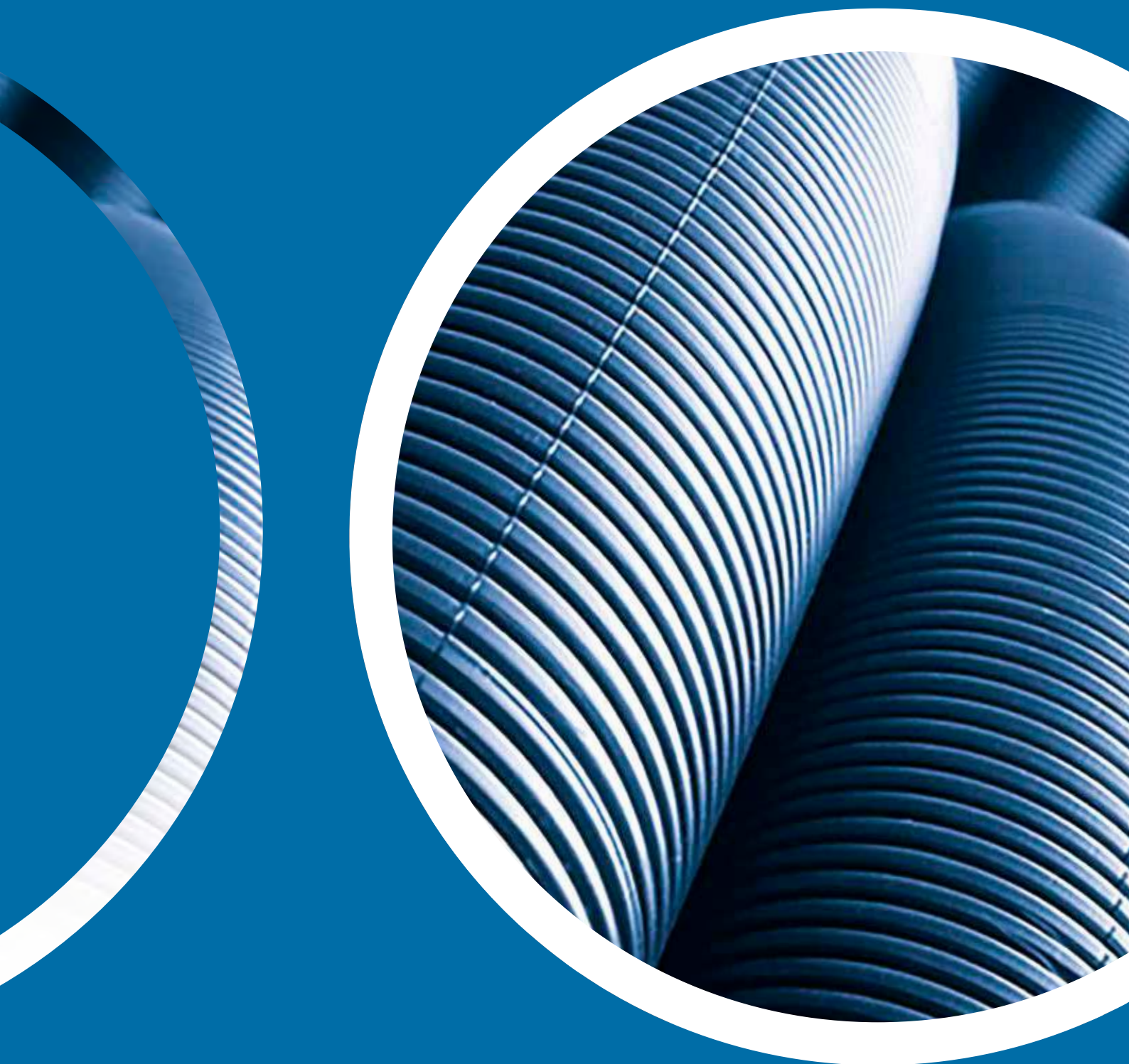
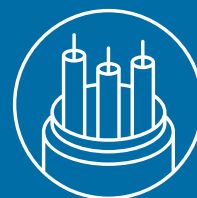



**PVC**

- 
**Resistente a la abrasión.**  
**Abrasion resistant.**

**USO APPLICATIONS**





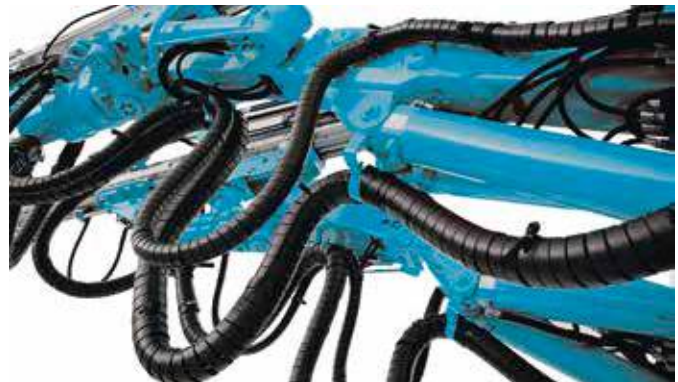

Vaina de protección en PVC rígido, para mangueras hidráulicas y cableados de mangueras múltiples. Resistente a la abrasión según ISO 4649 <150 mm<sup>3</sup>.



PVC rigid antiabrasion spiral for the protection of hydraulic hoses and multiple electric conduits. Abrasion resistant according to ISO 4649 <150 mm<sup>3</sup>.



**ESTRUCTURA BODY**

<b>A</b>	<b>Material</b>	PVC rígido. PVC rigid.
<b>B</b>	<b>Refuerzos</b> Reinforcement	--
<b>C</b>	<b>Capa exterior</b> Cover	--
	<b>Superficie</b> Surface	Negro. Black.

NOMINAL mm	 mm	 mm	 mm	 gr/mt	 mm	 m
13×16	13	15,4	1,2	50	10	20-50
16×20	16	18,4	1,2	62	12	20-50
20×25	20	23,6	1,8	120	14,5	20-50
24×29	23,5	27,3	1,9	160	15	20-50
27×32	27	30,8	1,9	195	16	20-50
30×35	30	34,4	2,2	230	18	20-50
35×40	35,5	40	2,2	280	20,5	20-50
44×50	43,5	48	2,3	400	23	20
56×63	56	61,5	2,7	570	26	20
65×75	66	73	3,5	770	30	20
80×90	82	90	3,8	1070	34	20
100×111	103	111	4,3	1550	46	20
120×131	124	132	5,4	2050	50	20

 <p><b>NORMAS</b> NORMS: ISO 1307</p> <p><b>AUTOEXTINGUIBLE</b> SELF-EXTINGUISHING: UL 94 V0</p> <p><b>DUREZA</b> HARDNESS: SH. 78 ± 3</p> <p><b>MARCADOR</b> MARKING: MOLLAFLEX (Ø INT X Ø EST) MADE IN ITALY</p>	 <p><b>-5°C / +60°C</b> <b>+23°F / +140°F</b></p>
--	--





PVC



- **Resistente a la abrasión.**  
Abrasion resistant.



**USO**  
**APPLICATIONS**

Vaina de protección resistente a la abrasión fabricada con material plástico especial, adecuada para proteger mangueras hidráulicas y cableado en maquinaria agrícola e industrial.

PVC rigid antiabrasion spiral for the protection of hydraulic hoses and multiple electric conduits.



**ESTRUCTURA**  
**BODY**

<b>A</b>	<b>Material</b>	PVC rígido. PVC rigid.
<b>B</b>	<b>Refuerzos</b>	--
<b>C</b>	<b>Capa exterior</b>	--
	<b>Superficie</b>	Varios colores. Various colors.

NOMINAL mm						
mm	mm	mm	mm	gr/mt	mm	m
7,5×10	7,5	10	1.2	35	-	20-50
9,5×12,5	9,5	12,5	1.5	48	-	20-50
13×16	13	16	1.5	60	-	20-50
16×20	16	20	2.0	75	-	20-50
20×25	20	25	2.5	140	-	20-50
24×29	24	29	2.5	180	-	20-50
27×32	27	32	2.5	220	-	20-50
30×35	30	35	2.5	250	-	20-50
35×40	35	40	2.5	310	-	20-50
44×50	44	50	3.0	430	-	20
56×63	56	63	3.5	610	-	20
65×75	65	75	5.0	820	-	20
80×90	80	90	5.0	1110	-	20
100×110	100	110	5.0	1650	-	20
150×159	150	162	6	2380	-	20



**NORMAS** NORMS:  
ISO 1307  
**DUREZA** HARDNESS:  
SH. 78 ± 3  
**MARCADOR** MARKING:  
MOLLAFLEX (Ø INT X Ø EST) MADE IN ITALY



**-20°C / +70°C**  
**+4°F / +158°F**

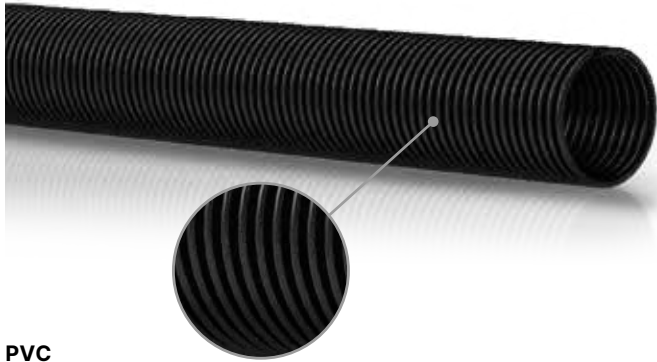

PVC



- **Adecuada para la protección de otras mangueras.**  
Suitable for hoses protection.



**USO APPLICATIONS**

Normalmente se utiliza como vaina de protección para otras mangueras. También se utiliza para el paso de aire en el sector del automóvil.

Used as protective covering for other hoses, for air delivery in the car sector.



**ESTRUCTURA BODY**

<b>A</b>	<b>Material</b>	Polipropileno corrugado. Polypropylene outside corrugated.
<b>B</b>	<b>Refuerzos</b> Reinforcement	--
<b>C</b>	<b>Capa exterior</b> Cover	--
	<b>Superficie</b> Surface	Negro. Black.



mm	mm	bar	bar	bar	gr/mt	mm	m
7,2	10	-	-	-	18	10	50
9,4	11,4	-	-	-	20	11	50
10,4	13,4	-	-	-	22	13	100
11,4	15,1	-	-	-	25	15	50
14,4	18,1	-	-	-	35	18	50
17	21,2	-	-	-	40	21	50
20	24,5	-	-	-	50	24	100
26,5	30,5	-	-	-	69	30	50
28	32,2	-	-	-	74	32	50
30,5	35	-	-	-	85	35	50
35	40,5	-	-	-	100	40	50
40,5	47,5	-	-	-	110	47	50
50,5	57,8	-	-	-	175	57	50
61	68	-	-	-	225	68	50
70	78	-	-	-	265	78	50
80	89,5	-	-	-	310	89	25
90,5	99,5	-	-	-	350	99	25
100	110,5	-	-	-	410	110	25
120	129	-	-	-	515	129	25
140	155	-	-	-	650	155	25



**NORMAS** NORMS:  
ISO 1307



**-5°C / +100°C**  
**+23°F / +212°F**



PVC



- **Vaina de protección de polipropileno para la protección de mangueras.**  
Polypropylene textile hose to the hoses protection.



**USO  
APPLICATIONS**



Se utiliza ampliamente para proteger mangueras hidráulicas, mangueras de goma, tuberías en PVC y cableados en maquinaria. Este tipo de vaina también puede utilizarse en campos industriales.

The tight woven construction can provide excellent abrasion resistance and high degree of burst resistance. It is widely used to protect hydraulic pipes, rubber hose, plastic pipes, wire harness from damage, this kind of sleeve can also be used in industrial and construction fields where outstanding hose productions are needed.



**ESTRUCTURA  
BODY**

<b>Material</b>	<b>Material</b>	Vaina de polipropileno, material resistente a los ácidos y a los álcalis. La construcción de tejido apretado puede proporcionar una excelente resistencia a la abrasión y un alto grado de resistencia a la rotura. Polypropylene textile hose sleeve is produced from polypropylene which is very hard-wearing and recyclable. Polypropylene is generally acid and alkali resistant.
<b>Superficie</b>	<b>Surface</b>	Negro. Black.

 FLAT - m	 mm	 m
30	18	100
35	21	100
40	24	100
45	28	100
50	31	100
55	35	100
60	37	100
65	41	100
80	50	50
90	56	50
100	62	50
120	76	50
150	95	50



Posibilidad de suministro en otros colores y tamaños.  
It is possible to receive the delivery in other colors or sizes.  
Longitudes especiales disponibles bajo pedido.  
Special lengths are only possible on request.  
Posibilidad de personalizar con logotipos previa solicitud.  
Personalization with logos possible on request.



**INFLAMABILIDAD MELTING POINT:**  
VW-1  
**PUNTO DE FUSIÓN FLAMMABILITY:**  
+125°C  
**ESPESOR ESTÁNDAR STANDARD THICKNESS:**  
1,2 mm



**-40°C / + 80°C**  
**-40°F / +176°F**



PVC



- **Funda protectora de nailon para proteger tuberías.**  
Nylon protective sleeve is made by nylon multifilament for hoses protection.



**USO APPLICATIONS**

Se utiliza habitualmente para proteger salas y maquinaria de posibles derrames de aceite hidráulico de la manguera. Se utiliza ampliamente para proteger mangueras hidráulicas, mangueras de goma, mangueras en PVC, este tipo de funda también se puede utilizar en campos industriales para proteger mangueras flexibles.



It is used to protect people, environment and machinery against any possible hydraulic hose oil leakage or spill. It is widely used to protect hydraulic pipes, rubber hose, wear harness from damage, this kind of sleeve can also be used in industrial and construction fields where outstanding hose productions are needed.



**ESTRUCTURA BODY**

<b>Material</b>	Material	Funda de protección de nylon multifilamento. La construcción de tejido apretado proporciona una excelente resistencia a la abrasión y un alto grado de resistencia a la rotura. Nylon protective sleeve is made by nylon multifilament. The tight woven construction can provide excellent abrasion resistance and high degree of burst resistance.
<b>Superficie</b>	Surface	Negro. Black.



 FLAT - m	 mm	 m
20	12	100
25	14	100
30	17	100
35	20	50
40	23	50
45	26	50
50	31	50
60	37	50
70	44	50
80	50	50
90	56	50
100	62	50
115	72	50
145	90	50
176	110	50



**INFLAMABILIDAD MELTING POINT:**  
VW-1  
**PUNTO DE FUSIÓN FLAMMABILITY:**  
+260°C  
**ESPESOR ESTÁNDAR STANDARD THICKNESS:**  
1,2 mm



**-60°C / + 160°C**  
**-76°F / +320°F**



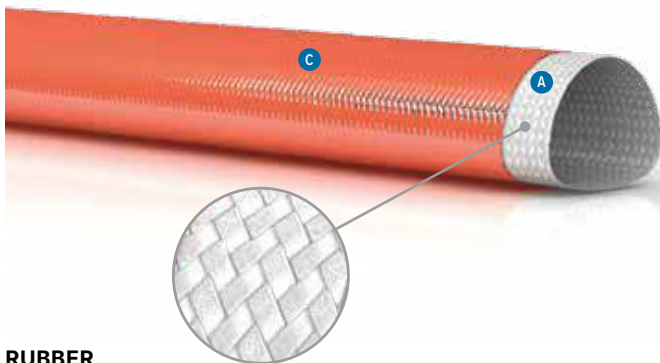

**RUBBER**



**USO APPLICATIONS**

Se utiliza para aislar trazadores de líneas de vapor en refinerías de petróleo, como aislamiento térmico y eléctrico para la industria de alambres y cables, en creaciones de vidrio, para tapas de extremos de acabados metálicos, fundiciones y acerías, y cualquier otra aplicación en la que se requiera una barrera protectora contra altas temperaturas.

It is used to insulate steam tracer lines in oil refineries, as thermal and electrical insulation for the wire and cable industry, in glass manufacturing, for covering tines in metal refining, foundries and steel mills, and wherever else a high temperature barrier might be required.



**ESTRUCTURA BODY**

**A**

**Capa interior Tube**

La funda en fibra de vidrio con silicona está formada por hilos de fibra de vidrio «E» y se utiliza en situaciones ambientales en las que las temperaturas superan los 538 °C (1000 °F). Gracias a esta construcción única, la fibra de vidrio se adapta fácilmente a mangueras y cables. Proporciona un mayor espesor de pared y, por tanto, ofrece un mejor aislamiento del calor.

Protech/SIL is a braided sleeving which is manufactured from E-fiberglass yarn. It is used in demanding environments where temperatures reach up to 1000 degrees F (538 degrees C.). Due to its unique construction, wall thickness at a nominal weight increase thereby providing better insulation against heat.

**B**

**Refuerzos Reinforcement**

--

**C**

**Capa exterior Cover**

Silicona.  
Silicon.

**Superficie Surface**

Exterior brillante.  
Shiny exterior.



- **Resistente a las altas temperaturas.**  
High temperature resistant.

Filamento en fibra de vidrio Fiberglass filament	Tipo Type "E"
Diámetro de la fibra de vidrio Fiberglass diameter	9 Micron
Resistencia a las llamas Fire resistance	Autoestinguente (V2) Self-extinguishes
Resistente al desgarro Rip resistance	19 kN/m
Carga de rotura Tensile strength	10 MPa
Alargamiento a la rotura Continuous operating temperature	260%
Rigidez dieléctrica Dielectric strength	26 kV/mm
Densidad a 23°C Density at 23°C	1,16 g/cm <sup>3</sup>

	PARED DE CRISTAL FIBERGLASS	PARED DE SILICONA SILICON COVER		
mm	mm	mm	gr/mt	m
10	2,5	1,0	-	20
12	2,5	1,0	-	20
15	2,5	1,0	-	20
20	2,5	1,0	-	20
25	2,5	1,0	-	20
30	2,5	1,0	-	20
35	2,5	1,0	-	20
38	2,5	1,0	-	20
40	2,5	1,0	-	20
42,5	2,5	1,0	-	20
45	2,5	1,0	-	15
50	2,5	1,0	-	15
60	2,5	1,0	-	15
65	2,5	1,0	-	15
70	2,5	1,0	-	15
75	2,5	1,0	-	15
80	2,5	1,0	-	15
85	2,5	1,0	-	15
90	2,5	1,0	-	15
100	2,5	1,0	-	15
115	2,5	1,0	-	15
125	2,5	1,0	-	15



**NORMAS NORMS:**  
R.I.N.A APPROVED ACCORDING TO ISO 15540:199(E) AND ISO 15541-199 (E) - UL 1441 VW-1



**+260°C**  
**+500°F**

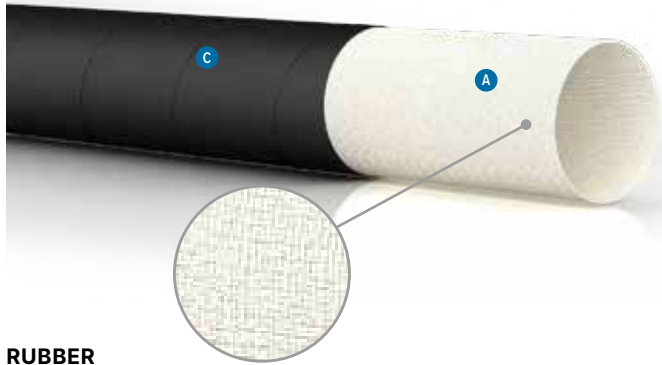

**RUBBER**



- **Vaina de protección para cables eléctricos.**  
Protection sleeve for electrical cables.

**USO APPLICATIONS**

Vaina para la protección de cables eléctricos y tuberías de máquinas de soldar y en todas las aplicaciones en las que se requiere una protección especialmente resistente.

Cable protection in industrial applications and welding machines.



**ESTRUCTURA BODY**

<b>A</b>	<b>Capa interior Tube</b>	Caucho NR CBR de color negro. Special synthetic rubber.
<b>B</b>	<b>Refuerzos Reinforcement</b>	Textiles sintéticos de alta resistencia. High tensile synthetic textile
<b>C</b>	<b>Capa exterior Cover</b>	Caucho NR/SBR de color negro, resistente a la abrasión, a los agentes atmosféricos y al envejecimiento. Abrasion, ozone and weather resistant special synthetic rubber.
	<b>Superficie Surface</b>	Lisa con impresión de tela. Smooth with fabric impression.

mm	mm	bar	bar	bar	gr/mt	mm	m
16	19	-	-	-	105	-	40
19	22	-	-	-	125	-	40
20	23	-	-	-	131	-	40
22	25	-	-	-	143	-	40
25	28	-	-	-	164	-	40
28	31	-	-	-	180	-	40
30	33	-	-	-	192	-	40
32	35	-	-	-	204	-	40
35	38	-	-	-	223	-	40
38	41	-	-	-	241	-	40
40	43	-	-	-	253	-	40
42	45	-	-	-	266	-	40
51	54	-	-	-	319	-	40
57	60	-	-	-	357	-	40

**NORMAS** NORMS:  
ISO 1307

**-30°C / +80°C**  
**-22°F / +176°F**

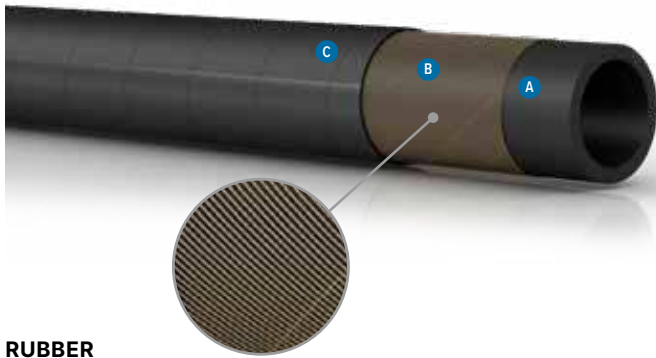

**RUBBER**



**USO  
APPLICATIONS**







Para vibradores neumáticos o eléctricos, para nivelar vertidos de hormigón. El caucho utilizado confiere a la manguera unas propiedades excepcionales de alargamiento y tracción, y la estructura especialmente gruesa garantiza que se evite la formación de cúspides, incluso en caso de radios de curvatura muy cerrados.

Utilized on submerged vibrators to prevent air bubbles in the concrete liquid projected by hand vibrating. Excellent traction and elongation characteristics thanks to its special rubber. The thickened structure avoid hose kinking.



**ESTRUCTURA  
BODY**

<b>A</b>	<b>Capa interior Tube</b>	Caucho NR SBR de color negro. Special synthetic rubber.
<b>B</b>	<b>Refuerzos Reinforcement</b>	Textiles sintéticos de alta resistencia. High tensile synthetic textile
<b>C</b>	<b>Capa exterior Cover</b>	Caucho NR/SBR de color negro, resistente a la abrasión, a los agentes atmosféricos y al envejecimiento. Abrasion, ozone and weather resistant special synthetic rubber.
	<b>Superficie Surface</b>	Lisa con impresión de tela. Smooth with fabric impression.

 mm	 mm	 bar	 bar	 bar	 gr/mt	 mm	 m
19	30	10	30	-	587	190	40-60
22	30	10	30	-	430	220	40-60
25	36	10	30	-	682	250	40-60
25	39	10	30	-	926	250	40-60
25	42	10	30	-	1190	250	40-60
28	44	10	30	-	1245	280	40-60
38	54	10	30	-	1318	380	40-60
40	54	10	30	-	1419	400	40-60



**NORMAS** NORMS:  
ISO 1307  
**EMBALAJE** BOX:  
EMBALAJE EN POLIETILENO AMARILLO  
PACKAGING IN YELLOW POLYETHYLENE



**-40°C / +70°C**  
**-40°F / +158°F**

# MANGUERAS TRENZADAS DE ACERO

TEXTILE AND STEEL WIRE HOSES

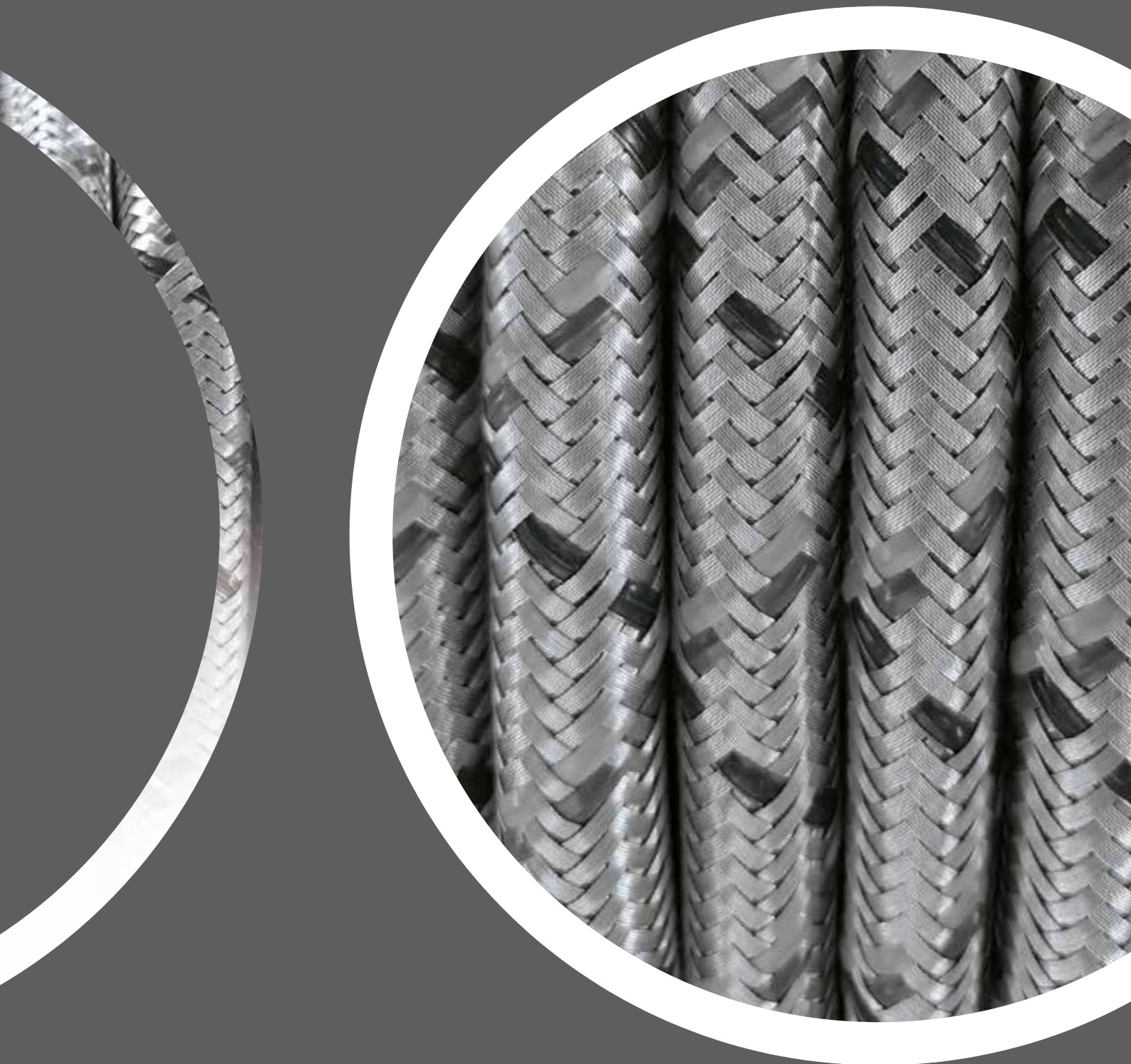
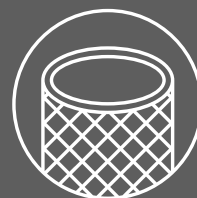



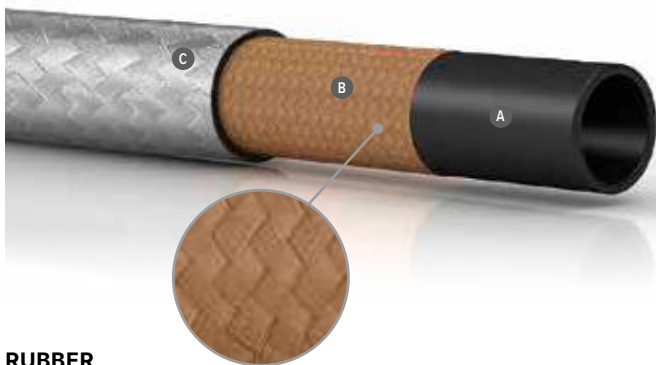

RUBBER



- **Manguera trenzada para entrega de fluidos hidráulicos.**  
Galvanized steel wire hose for the hydraulic fluids delivery.
- **Ideal en el sector hidráulico.**  
Ideal for the hydraulic sector.



### USO APPLICATIONS

Manguera en caucho trenzado de acero galvanizado adecuada para el suministro de fluidos hidráulicos, aceites minerales, lubricantes, gasóleo, nafta y aire.

Galvanized steel wire rubber hose suitable for delivery of hydraulic fluid, oils, lubricants and air.

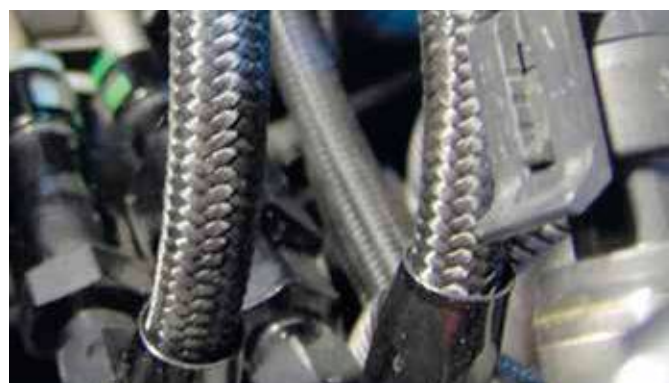

### ESTRUCTURA BODY

<b>A</b> Capa interior Tube	Lisa en caucho NBR de color negro. Black, smooth NBR rubber.
<b>B</b> Refuerzos Reinforcement	Trenzas de hilo sintético de alta resistencia. High tensile synthetic textile braid.
<b>C</b> Capa exterior Cover	Lisa impresión tela de caucho CR resistente a los aceites, a la abrasión y a los agentes atmosféricos. Smooth, fabric finished, black, abrasion, oils and weather resistant CR rubber.
<b>Superficie Surface</b>	Trenzado de acero galvanizado. Galvanized braided finished.

mm	mm	bar	bar	bar	gr/mt	mm	m
4,8	11,9	34	136	-	99	50	10-100
6,4	13,5	28	112	-	100	65	10-100
7,9	15,1	28	112	-	125	75	10-100
9,5	16,7	28	112	-	150	75	10-100
12,7	20,6	28	112	-	200	100	10-100
15,9	23,8	24	96	-	250	125	10-100
19	27,8	21	84	-	300	150	10-100
25,4	33,4	12	48	-	450	135	10-100



**NORMAS** NORMS:  
SAE J 517 - SAE 100 R6 - EN 854 TYPE R6 - ISO 1307  
**EMBALAJE** BOX:  
EMBALAJE DE CARTÓN  
CARTON BOXES



**-40°C / +100°C**  
**-40°F / +212°F**

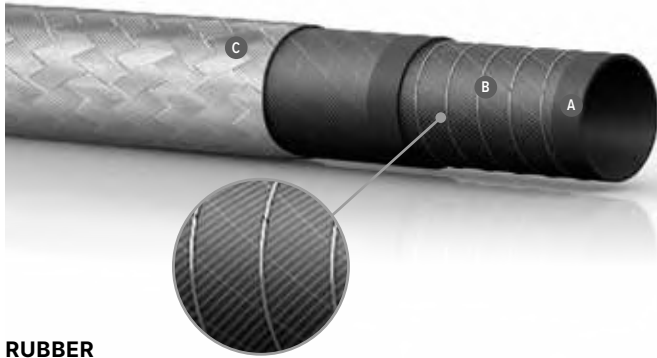

**RUBBER**



- **Manguera trenzada para entrega de fluidos hidráulicos.**  
Galvanized steel wire hose for the hydraulic fluids delivery.
- **Ideal en el sector hidráulico.**  
Ideal for the hydraulic sector.



**USO APPLICATIONS**





Manguera de caucho en espiral trenzada de acero galvanizado adecuada para la aspiración y entrega de fluidos hidráulicos, aceites minerales y carburantes.

Galvanized steel wire rubber hose suitable for suction and delivery of hydraulic fluids, mineral oils and fuels.



**ESTRUCTURA BODY**

<b>A</b> <b>Capa interior Tube</b>	Lisa en caucho NBR de color negro resistente a los productos de petróleo con un contenido de aromáticos de hasta el 40%. Black, smooth, petroleum products up to 40% aromatic content resistant NBR rubber.
<b>B</b> <b>Refuerzos Reinforcement</b>	Espiral metálica incorporada con tejidos sintéticos de alta resistencia, hilo de cobre. Steel wire helix with high strength synthetic textile plies. Copper wire.
<b>C</b> <b>Capa exterior Cover</b>	Lisa impresión tela en caucho negro CR/NBR resistente a los aceites, a la abrasión, a los carburantes, a los agentes atmosféricos y al calor. Oil, heat, abrasion, ozone and weather resistant special synthetic rubber.
<b>Superficie Surface</b>	Trenzado de acero galvanizado. Galvanized braided finished.

 mm	 mm	 bar	 bar	 bar	 gr/mt	 mm	 m
19	30,2	21	84	0,8	840	115	40
22	31,2	10	30	0,8	910	130	40
25,4	36,2	17	68	0,8	1080	150	40
28	40,2	10	68	0,8	1160	170	40
32	43,2	14	56	0,8	1440	190	40
35	47,2	10	30	0,8	1630	210	40
38	50,2	10	40	0,8	1670	230	40
40	53,2	10	30	0,8	1800	240	40
42	57,2	10	30	0,8	2030	255	40
45	58,2	10	30	0,8	2190	270	40
50,8	63,2	10	30	0,8	2310	305	40
60	73,2	10	30	0,8	2970	360	40
63,5	76,7	10	30	0,8	3250	380	40
70	85,2	10	30	0,8	3950	420	40
76,2	89,2	10	30	0,8	4210	460	40
90	104,2	10	30	0,8	5010	540	20-40
102	116,2	10	30	0,8	5680	610	20-40



**NORMAS** NORMS:  
SAE J 517 - SAE 100 R4 - ISO 1307  
**EMBALAJE** BOX:  
EMBALAJE DE CARTÓN  
CARTON BOXES



**-40°C / +93°C**  
**-40°F / +199,4°F**

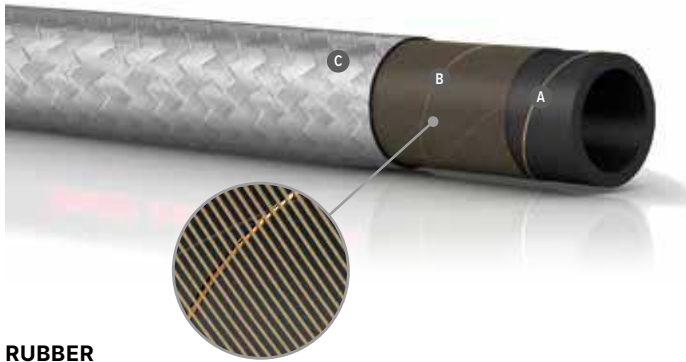

**RUBBER**



- **Manguera trenzada para entrega de carburante en los motores de combustión interna.**  
Galvanized steel wire hose for the fuel delivery in internal combustion engines.
- **Excelente ligereza y flexibilidad.**  
Excellent lightness and flexibility.



**USO  
APPLICATIONS**









Adecuada para suministro de combustibles en motores de combustión interna, lubricación y engrase de maquinaria; especialmente indicada cuando se requiere ligereza y flexibilidad.

For delivery of fuels in internal combustion engines for lubrication and greasing services. Particularly used where it is necessary lightness and flexibility.



**ESTRUCTURA  
BODY**

<b>A</b> <b>Capa interior Tube</b>	Lisa en caucho NBR de color negro resistente a aceites, óleo y carburantes con un contenido aromático de hasta el 40%. Fuel and oil resistant up tu 40%, smooth NBR rubber.
<b>B</b> <b>Refuerzos Reinforcement</b>	Textiles sintéticos. High tensile synthetic textile.
<b>C</b> <b>Capa exterior Cover</b>	Lisa en caucho NBR resistente al aceite y al carburante. Abrasion, ozone, weather and oil resistant special synthetic rubber.
<b>Superficie Surface</b>	Revestimiento en funda de acero inoxidable. Galvanized steel wire braided cover.

 mm	 mm	 bar	 bar	 bar	 gr/mt	 mm	 m
4	10,2	10	30	-	300	40	100
5	13,2	10	30	-	350	50	100
6	13,2	10	30	-	440	50	100
8	16,2	10	30	-	540	65	100
10	18,2	10	30	-	660	80	100
13	21,2	10	30	-	740	105	100
15	24,2	10	30	-	770	120	50
19	28,2	10	30	-	755	130	50
25	36,2	10	30	-	950	150	50



**NORMAS** NORMS:  
ISO 1307  
**EMBALAJE** BOX:  
EMBALAJE DE CARTÓN  
CARTON BOXES



**-35°C / +70°C**  
**-31°F / +158°F**

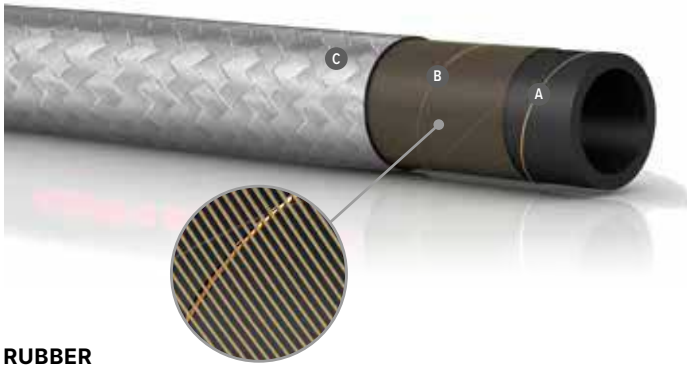

- **Manguera trenzada para entrega de aceite, óleo y carburantes. Galvanized steel wire hose for the oils and fuels delivery.**

**RUBBER**

**USO APPLICATIONS**

Adecuada para entrega de aceites minerales, gasóleo, gasolina y carburantes. Especialmente adecuada para la descarga y carga solamente por impulsión de camiones cisterna, en refinerías y estaciones de servicio.

For delivery of petroleum products with aromatic content up to 50%.



**ESTRUCTURA BODY**

<b>A</b> Capa interior Tube	Caucho NBR de color negro, resistente al carburante, con un contenido aromático no superior al 50%. Oil and petrol resistant up to 50%, black NBR.
<b>B</b> Refuerzos Reinforcement	Textiles y sintéticos con hilo de cobre para garantizar la disipación de la electricidad estática. High tensile synthetic textile and antistatic copper wire.
<b>C</b> Capa exterior Cover	Caucho NBR/SBR resistente a los combustibles, aceites, ozono y a los agentes atmosféricos. Abrasion, ozone, weather and oil resistant special synthetic rubber.
<b>Superficie Surface</b>	Revestimiento en funda de acero galvanizado. Galvanized steel wire braided cover.

mm	mm	bar	bar	bar	gr/mt	mm	m
19	28,2	10	30	-	430	-	40
25	39,2	10	30	-	560	-	40
30	41,2	10	30	-	800	-	40
32	43,2	10	30	-	850	-	40
35	46,2	10	30	-	930	-	40
38	49,2	10	30	-	970	-	40
40	51,2	10	30	-	1050	-	40
45	57,2	10	30	-	1200	-	40
50	63,2	10	30	-	1350	-	40
60	73,2	10	30	-	1700	-	40

**NORMAS** NORMS:  
ISO 1307

**EMBALAJE** BOX:  
EMBALAJE DE CARTÓN  
CARTON BOXES

**-35°C / +70°C**  
**-31°F / +158°F**



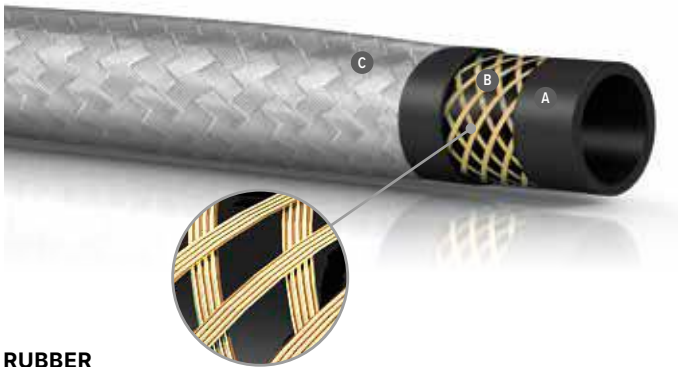

**RUBBER**



- **Manguera trenzada adecuada para entrega a alta presión de fluidos hidráulicos.**  
Galvanized steel wire hose for the high pressure delivery of hydraulic fluids.



**USO APPLICATIONS**









Manguera en caucho con refuerzo de acero trenzado adecuada para entrega a alta presión de fluidos hidráulicos a base de aceite mineral y lubricantes vegetales y minerales.

Rubber hose suitable for delivery of high pressure hydraulic fluids, using hydraulic oils mineral and vegetable lubricants.



**ESTRUCTURA BODY**

<b>A</b> <b>Capa interior Tube</b>	Caucho sintético resistente a los fluidos hidráulicos a base de aceites minerales y vegetales. Syntetic rubber, extruded whole without joints of uniform thickness.
<b>B</b> <b>Refuerzos Reinforcement</b>	1 trenza de acero de alta resistencia. 1 high strength steel wire braid.
<b>C</b> <b>Capa exterior Cover</b>	Lisa impresión tela en caucho negro resistente a la abrasión, a los carburantes, a los aceites y a los agentes atmosféricos. Smooth, fabric finished, oil abrasion and weather resistant special synthetic rubber.
<b>Superficie Surface</b>	Trenzado de acero galvanizado. Galvanized braided finished.

 mm	 mm	 bar	 bar	 bar	 gr/mt	 mm	 m
6,4	13,5	225	1100	-	280	75	LONGITUD VARIABLE VARIABLE SIZE
8	14,7	215	1050	-	320	85	
9,5	16,9	180	880	-	390	90	
12,7	20,1	160	700	-	510	130	
16	23,6	130	650	-	620	150	
19	27,1	105	520	-	740	180	
25,4	34,9	88	430	-	1040	230	
31,8	44,7	63	250	-	1270	420	
38,1	52	50	200	-	1596	500	



**NORMAS NORMS:**  
ISO 1307  
**EMBALAJE BOX:**  
EMBALAJE DE CARTÓN  
CARTON BOXES



**-40°C / +100°C**  
**-40°F / +212°F**



**RUBBER**



- **Manguera trenzada para entrega a alta presión de fluidos hidráulicos. Galvanized steel wire hose for the high pressure delivery of hydraulic fluids.**

**USO APPLICATIONS**

Manguera en caucho con refuerzo de acero trenzado adecuada para entrega a alta presión de fluidos hidráulicos a base de aceite mineral y lubricantes vegetales y minerales.

Rubber hose suitable for delivery of high pressure hydraulic fluids, using hydraulic oils mineral and vegetable lubricants.



**ESTRUCTURA BODY**

<b>A</b> <b>Capa interior Tube</b>	Caucho sintético resistente a los fluidos hidráulicos a base de aceites minerales y vegetales. Mineral vegetable and hydraulic synthetic rubber.
<b>B</b> <b>Refuerzos Reinforcement</b>	2 trenzas de acero de alta resistencia. 2 high strength steel wire braid.
<b>C</b> <b>Capa exterior Cover</b>	Lisa impresión tela en caucho negro resistente a la abrasión, a los combustibles, a los aceites y a los agentes atmosféricos. Smooth, fabric finished, oil abrasion and weather resistant special synthetic rubber.
<b>Superficie Surface</b>	Trenzado de acero galvanizado. Galvanized braided finished.

mm	mm	bar	bar	bar	gr/mt	mm	m
6,4	14,5	400	1850	-	390	75	LONGITUD VARIABLE VARIABLE SIZE
8	16	350	1700	-	460	85	
9,5	18,3	330	1550	-	550	90	
12,7	21,6	275	1270	-	740	130	
16	24,7	250	1150	-	910	170	
19	28,8	215	1000	-	1070	200	
25,4	37	165	840	-	1510	250	
31,8	49,5	125	500	-	2035	420	
38,1	55,8	90	360	-	2300	500	

**NORMAS NORMS:**  
ISO 1307

**MARCADOR MARKING:**  
EUROCORD® OIL DELIVERY HOSE W.P. 10 BAR

**EMBALAJE BOX:**  
EMBALAJE DE CARTÓN  
CARTON BOXES

**-40°C / +100°C**  
**-40°F / +212°F**

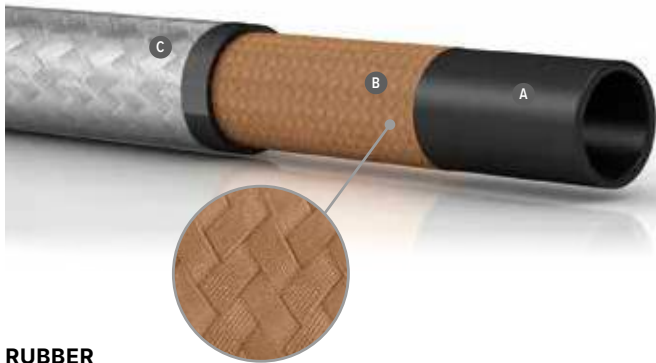

**RUBBER**



- **Manguera trenzada para entrega de fluidos hidráulicos.**  
Galvanized steel wire hose for the hydraulic fluids delivery.



**USO APPLICATIONS**

Manguera de goma trenzada de acero galvanizado adecuada para entrega de fluidos hidráulicos, aceites, lubricantes, nafta y aire.

Galvanized steel wire rubber hose suitable for delivery of hydraulic fluid, oils, lubricants and air.



**ESTRUCTURA BODY**

<b>A</b> Capa interior Tube	Lisa en caucho negro antiabrasiva (NR/NBR). Black, smooth NR/NBR rubber.
<b>B</b> Refuerzos Reinforcement	Textiles sintéticos de alta tenacidad. High strength synthetic textile braid.
<b>C</b> Capa exterior Cover	Lisa impresión tela en caucho CR resistente a la abrasión, a los aceites y a los agentes atmosféricos. Smooth, fabric finished, black, abrasion, oils and weathering resistant CR rubber.
<b>Superficie Surface</b>	Trenzado de acero galvanizado. Galvanized braided finished.

mm	inch	mm	bar	bar	bar	gr/mt	mm	m
4,8	3/16	13	80	320	-	220	25	10-80
6,4	1/4	14,6	75	300	-	260	40	10-80
7,9	5/16	16,1	68	272	-	290	50	10-80
9,5	3/8	17,7	63	252	-	320	60	10-80
12,7	1/2	21	58	232	-	410	70	10-80
15,9	5/8	25,1	50	200	-	540	90	10-80
19	3/4	28,2	45	180	-	630	110	10-80
25,4	1	35,6	40	160	-	890	150	10-80



**NORMAS NORMS:**  
EN 854 TYPE 2TE - DIN 20021 2TE - ISO 4079/1  
2TE - ISO 1307  
**EMBALAJE BOX:**  
EMBALAJE DE CARTÓN  
CARTON BOXES



**-40°C / +100°C**  
**-40°F / +212°F**

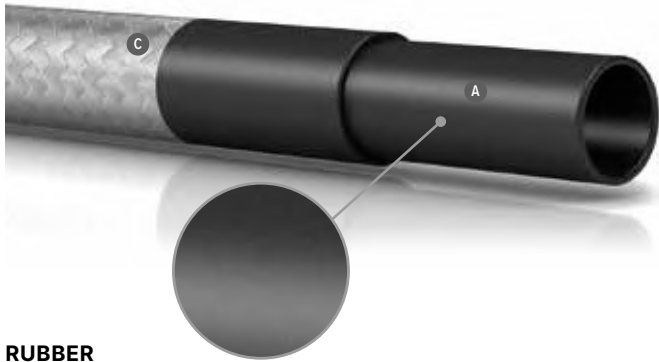

- **Manguera NBR trenzado flexible.**  
Flexible NBR galvanized steel wire hose.

**RUBBER**

**USO APPLICATIONS**

Manguera para entrega de aceites minerales, lubricantes y gasóleo.

For delivery of transmission oil, fuel oil, gasoline.



**ESTRUCTURA BODY**

<b>A</b> Capa interior Tube	Lisa, color negro, de extrusión simple en caucho NBR, dureza Shore 80 A+/-5. Black, smooth, monolayer NBR rubber with hardness 80 shore A+/-5.
<b>B</b> Refuerzos Reinforcement	--
<b>C</b> Capa exterior Cover	Trenzado de alambre de acero galvanizado con dos hilos de identificación: rojo y negro. Galvanized steel wire braiding with two identification wires: red and black.
<b>Superficie Surface</b>	Trenzado. Galvanized wire braid.

mm	inch	mm	bar	bar	bar	gr/mt	mm	m
6	1/4	11	25	75	-	-	-	50-100
8	5/16	13	25	75	-	-	-	50-100
10	3/8	15	25	75	-	-	-	50-100
13	1/2	19	20	60	-	-	-	50-100
16	5/8	22	20	60	-	-	-	40-50
19	3/4	25	15	45	-	-	-	40-50
25	1	33	15	45	-	-	-	40-50

**ABRAZADERAS Y COLLARES DE APRIETE RECOMENDADOS RECOMMENDED CLAMP/COLLAR**

STF - Abrazaderas de tornillo Hose clamps with screw (pag. 204-207)



**NORMAS NORMS:**  
EN 854 TYPE 2TE - DIN 20021 2TE - ISO 4079/1  
2TE - ISO 1307  
**EMBALAJE BOX:**  
EMBALAJE DE CARTÓN  
CARTON BOXES



**-35°C / +90°C**  
**-31°F / +194°F**



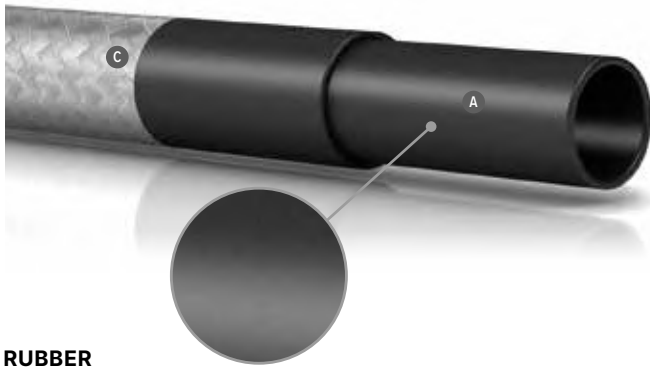

**RUBBER**



- **Manguera de EPDM trenzada.**  
Flexible EPDM galvanized steel wire hose.



**USO  
APPLICATIONS**









Manguera para entrega a presión de agua caliente y líquidos no corrosivos en equipos e instalaciones de diversos tipos.

For the delivery of water and liquids with light chemical content.



**ESTRUCTURA  
BODY**

<b>A</b> Capa interior Tube	Liso de color negro en caucho EPDM, dureza Shore 80 A +/-5. Smooth black EPDM rubber.
<b>B</b> Refuerzos Reinforcement	Textiles sintéticos. High tensile synthetic textile.
<b>C</b> Capa exterior Cover	Trenzado de alambre de acero galvanizado con dos hilos de identificación: rojo y azul. Galvanized steel wire braiding with two identification wires: red and blue.
<b>Superficie Surface</b>	Trenzado. Braided.

 mm	 inch	 mm	 bar	 bar	 bar	 gr/mt	 mm	 m
10	3/8	15	25	75	-	-	-	40-100
13	1/2	19	25	75	-	-	-	40-100
16	5/8	23	20	60	-	-	-	40-50
19	3/4	26	20	60	-	-	-	40-50
25	1	33	15	45	-	-	-	40-50
32	1 1/4	43	10	30	-	-	-	40
35	1 3/8	48	10	30	-	-	-	40
38	1 1/2	51	10	30	-	-	-	40
40	1 9/16	53	10	30	-	-	-	40
45	1 49/64	61	10	30	-	-	-	40
51	2	64	10	30	-	-	-	40
60	2 23/64	82	10	30	-	-	-	40



**NORMAS** NORMS:  
ISO 1307  
**EMBALAJE** BOX:  
EMBALAJE DE CARTÓN  
CARTON BOXES



**-30°C / +100°C**  
**-22°F / +212°F**

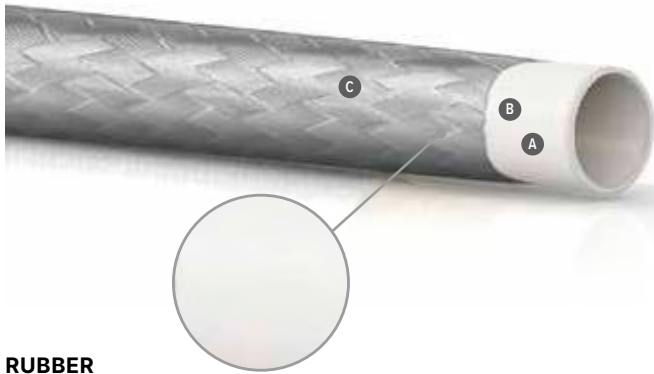

**RUBBER**



**USO APPLICATIONS**

Manguera trenzada de acero inoxidable P.T.F.E. adecuada para sistemas hidráulicos, circuitos de lubricación, paso de carburante y vapores a altas temperaturas. Se utiliza especialmente en las industrias alimentaria, química y farmacéutica.

Stainless wire braided one-layer P.T.F.E hose suitable for hydraulic and lubricant system, fuel and steam high temperature delivery. Particularly suitable for food, chemical and pharmaceutical industries.



**ESTRUCTURA BODY**

<b>A</b>	<b>Capa interior Tube</b>	P.T.F.E. extruido. P.T.F.E one layer.
<b>B</b>	<b>Refuerzos Reinforcement</b>	Trenzado de alambre de acero inoxidable AISI 304. Stainless AISI 304 wire braid.
<b>C</b>	<b>Capa exterior Cover</b>	Trenzado de alambre de acero inoxidable AISI 304. Stainless AISI 304 wire braid.
	<b>Superficie Surface</b>	Trenzado. Braided.

3	1/8	6,2	276	828	-	-	51	LONGITUD VARIABLE VARIABLE SIZE
5	3/16	7,6	264	793	-	-	64	
6	1/4	8,8	224	672	-	-	76	
8	5/16	11	207	621	-	-	102	
9,5	3/8	12,1	183	552	-	-	133	
10,3	13/32	13,7	140	480	-	-	135	
12,5	1/2	20,2	161	483	-	-	152	
16	5/8	18,8	114	345	-	-	178	
19	3/4	23,1	103	310	-	-	203	
22,2	7/8	26,2	92	276	-	-	229	
25	1	29,2	80	241	-	-	305	
29	1	33,1	44	176	-	-	410	



**NORMAS NORMS:**  
ISO 1307  
**EMBALAJE BOX:**  
EMBALAJE DE CARTÓN  
CARTON BOXES



**-70°C / +260°C**  
**-94°F / +500°F**

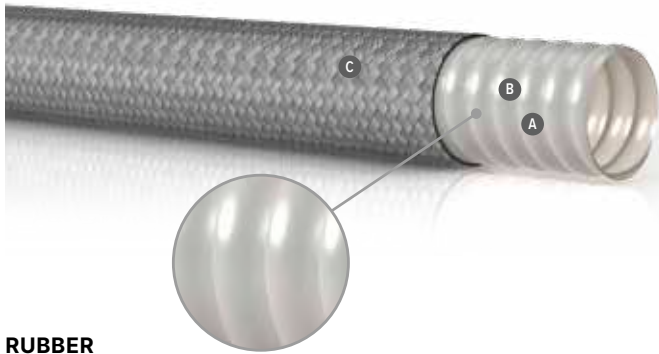

**RUBBER**



**USO  
APPLICATIONS**

Manguera convoluta trenzada de acero inoxidable P.T.F.E. adecuada para sistemas hidráulicos, circuitos de lubricación, carburante y paso de vapores a alta temperatura. Se utiliza especialmente en las industrias alimentaria, química y farmacéutica.

Stainless wire braided one-layer P.T.F.E convoluted hose suitable for hydraulic and lubricant system, fuel and steam high temperature delivery. Particularly suitable for food, chemical and pharmaceutical industries.



**ESTRUCTURA  
BODY**

<b>A</b>	<b>Capa interior Tube</b>	P.T.F.E. corrugado. Convoluted P.T.F.E.
<b>B</b>	<b>Refuerzos Reinforcement</b>	Trenzado de alambre de acero inoxidable AISI 304. Stainless AISI 304 wire braid.
<b>C</b>	<b>Capa exterior Cover</b>	Trenzado de alambre de acero inoxidable AISI 304. Stainless AISI 304 wire braid.
	<b>Superficie Surface</b>	Trenzado. Braided.

6	1/4	10,6	-	800	0,7	-	18	LONGITUD VARIABLE VARIABLE SIZE
7,5	5/16	14	-	650	0,7	-	19	
9,7	3/8	16,4	-	500	0,7	-	20	
13	1/2	19	-	309	0,7	-	25	
15,5	5/8	21	-	350	0,8	-	50	
19,6	3/4	26	-	250	0,8	-	64	
24,4	1	33,7	-	200	1	-	90	
32,5	1 1/4	40,3	-	170	1	-	110	
38	1 1/2	48,4	-	120	1	-	150	
50,9	2	61,4	-	100	1,1	-	190	



**NORMAS** NORMS:  
ISO 1307  
**EMBALAJE** BOX:  
EMBALAJE DE CARTÓN  
CARTON BOXES



**-70°C / +260°C**  
**-94°F / +500°F**

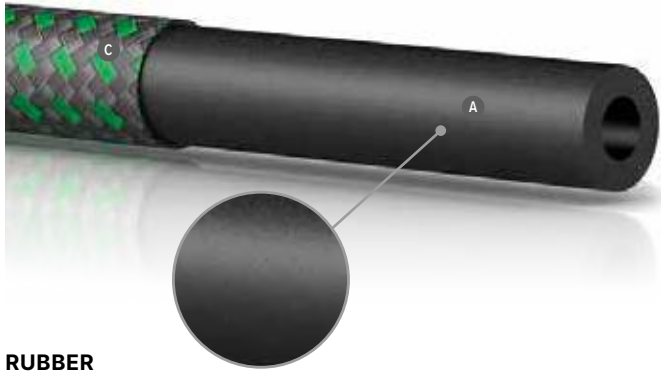

- Ideal para motores de combustión interna.  
Ideal for the internal combustion engine.
- Puede suministrarse en bobina.  
Available also on reel.



**RUBBER**



**USO  
APPLICATIONS**

Adecuada para entrega de gasolina ecológica, lubricantes, aceites minerales y carburantes. Especialmente utilizada en motores de combustión interna.

For delivery of fuel oil, gasoline, etc. Widely used in internal combustion engines.



**ESTRUCTURA  
BODY**

<b>A</b> Capa interior Tube	Lisa en caucho NBR resistente a los productos de petróleo con un contenido de aromáticos de hasta el 40%. Oil and fuel resistant NBR rubber resistant to petroleum products with aromatic content of not over 40%.
<b>B</b> Refuerzos Reinforcement	--
<b>C</b> Capa exterior Cover	Trenza textil vulcanizada negra de alta tenacidad, impregnada con una solución de neopreno que garantiza que la manguera sea autoextinguible e imputrescible. Textile braid impregnated with neoprene solution.
Superficie Surface	Trenzado. Braided.



**ABRAZADERAS Y COLLARES DE APRIETE  
RECOMENDADOS  
RECOMMENDED CLAMP/COLLAR**

STF - Abrazaderas de tornillo Hose clamps with screw (pag. 204-207)



mm	inch	mm	bar	bar	bar	gr/mt	mm	m
3	1/8	7	10	30	-	40	25	100
4	1/6	8	10	30	-	50	35	100
5	3/16	10	10	30	-	80	40	100
6	1/4	11	10	30	-	100	50	100
6	1/4	13	10	30	-	140	50	100
7	5/18	13	10	30	-	130	55	100
7,5	5/16	14,5	10	30	-	160	60	100
8	5/16	13	10	30	-	110	65	100
8	5/16	15	10	30	-	160	65	100
10	3/8	15	10	30	-	140	80	100
10	3/8	17	10	30	-	190	80	100
13	1/2	20	10	30	-	240	130	100
16	5/8	23	10	30	-	280	160	100
19	3/4	27	10	30	-	380	190	100
25	1	33	10	30	-	500	250	100



**NORMAS** NORMS:  
ISO 1307  
**EMBALAJE** BOX:  
EMBALAJE DE CARTÓN  
CARTON BOXES



**-40°C / +85°C**  
**-40°F / +185°F**



# MANGUERAS PARA AGUA CALIENTE Y VAPOR

HOT WATER AND STEAM HOSES





**RUBBER**

**USO APPLICATIONS**

Manguera para entrega a presión de aire, agua caliente y líquidos ligeramente corrosivos en equipos e instalaciones de diversos tipos.

For delivery of hot water with light chemical content in industrial applications.



**ESTRUCTURA BODY**

<b>A</b> Capa interior Tube	Lisa, de color negro, en caucho EPDM. EPDM rubber.
<b>B</b> Refuerzos Reinforcement	Textiles sintéticos. High tensile synthetic textile.
<b>C</b> Capa exterior Cover	Lisa en caucho EPDM de color negro, resistente a la temperatura, a la abrasión, a los agentes atmosféricos y al ozono. Abrasion, heat, ozone and weather resistant, smooth EPDM rubber.
Superficie Surface	Lisa. Smooth.

mm	mm	bar	bar	bar	gr/mt	mm	m
5	10,5	10	30	-	82	50	50-100
5	11	10	30	-	93	50	50-100
6	12	10	30	-	102	60	50-100
7	13	10	30	-	120	70	50-100
8	15	10	30	-	160	80	50-100
10	17	10	30	-	185	100	50-100
12	18	10	30	-	155	120	50-100
13	19	10	30	-	180	130	50-100
15	21	10	30	-	205	150	50-100
15	23	10	30	-	360	150	50-100
19	26	10	30	-	310	190	50-100
20	30	10	30	-	480	200	50-100
22	30	10	30	-	390	220	50-100
25	33	10	30	-	550	250	50-100
25	35	10	30	-	610	250	50-100

**ABRAZADERAS Y COLLARES DE APRIETE RECOMENDADOS RECOMMENDED CLAMP/COLLAR**

STF - Abrazaderas de tornillo Hose clamps with screw (pag. 204-207)  
SGT - Abrazaderas pinzables Stepp less (pag. 216)



**NORMAS** NORMS:  
ISO 1307

**MARCADOR** MARKING:  
EUROCORD® HOT WATER 100°C - ISO 1307

**EMBALAJE** BOX:  
EMBALAJE EN POLIETILENO TRANSPARENTE  
PACKAGING IN TRANSPARENT POLYETHYLENE

**-40°C / +125°C**  
**-40°F / +257°F**



**RUBBER**



### USO APPLICATIONS

Manguera para entrega a presión de aire, agua caliente y líquidos ligeramente corrosivos en equipos e instalaciones de diversos tipos.

For delivery of hot water with very light chemical content in industrial applications.



### ESTRUCTURA BODY









<b>A</b>	<b>Capa interior Tube</b>	Lisa, de color negro, en caucho EPDM. EPDM rubber.
<b>B</b>	<b>Refuerzos Reinforcement</b>	Textiles sintéticos. High tensile synthetic textile.
<b>C</b>	<b>Capa exterior Cover</b>	Lisa en caucho EPDM de color negro, resistente a la temperatura, a la abrasión, a los agentes atmosféricos y al ozono. Abrasion, heat, ozone and weather resistant, smooth EPDM rubber.
	<b>Superficie Surface</b>	Lisa. Smooth.



### ABRAZADERAS Y COLLARES DE APRIETE RECOMENDADOS RECOMMENDED CLAMP/COLLAR

STF - Abrazaderas de tornillo Hose clamps with screw (pag. 204-207)  
SGT - Abrazaderas pinzables Stepp less (pag. 216)



 mm	 mm	 bar	 bar	 bar	 gr/mt	 mm	 m
5	10,5	20	60	-	82	50	50-100
5	11	20	60	-	93	50	50-100
6	12	20	60	-	102	60	50-100
7	13	20	60	-	120	70	50-100
8	16	20	60	-	175	80	50-100
10	18	20	60	-	220	100	50-100
13	21	20	60	-	320	130	50-100
19	28	20	60	-	440	190	50
25	35	20	60	-	650	250	50



**NORMAS** NORMS:  
ISO 1307  
**MARCADOR** MARKING:  
EUROCORD® HOT WATER 100°C - ISO 1307

**EMBALAJE** BOX:  
EMBALAJE EN POLIETILENO TRANSPARENTE  
PACKAGING IN TRANSPARENT POLYETHYLENE



**-40°C / +110°C**  
**-40°F / +230°F**



**RUBBER**



- **Estructura adecuada para el montaje como manguera en extintores.**  
Suitable structure for the installation on the fire extinguishers.

**USO APPLICATIONS**

Manguera adecuada para la conducción de espuma y gases extintores. El ata particular está especialmente diseñado para montarse como manguera en extintores fijos y móviles.

For fire extinguishers.



**ESTRUCTURA BODY**

<b>A</b> Capa interior Tube	Lisa en caucho EPDM de color negro, resistente a la temperatura, a la abrasión, a los agentes atmosféricos y al ozono. Ozone, abrasion, and weather resistant special synthetic EPDM rubber.
<b>B</b> Refuerzos Reinforcement	Textiles sintéticos de alta resistencia. High tensile synthetic textile.
<b>C</b> Capa exterior Cover	Lisa en caucho EPDM de color negro, resistente a la temperatura, a la abrasión, a los agentes atmosféricos y al ozono. Ozone, abrasion, and weather resistant special synthetic EPDM rubber.
Superficie Surface	Lisa. Smooth.

mm	mm	bar	bar	bar	gr/mt	mm	m
10	19	20	60	-	290	100	100
12,5	20,5	20	60	-	260	125	100
13	22,5	20	60	-	340	130	100
16	26	20	60	-	440	160	50
19	29	20	60	-	500	190	50

**ABRAZADERAS Y COLLARES DE APRIETE RECOMENDADOS**  
**RECOMMENDED CLAMP/COLLAR**

- STF - Abrazaderas de tornillo Hose clamps with screw (pag. 204-207)
- SGT - Abrazaderas pinzables Stepp less (pag. 216)



**NORMAS NORMS:**  
ISO 1307  
**MARCADOR MARKING:**  
EUROCORD® EPDM EXTINGUISHER P.E. 20 BAR - ISO 1307  
**EMBALAJE BOX:**  
EMBALAJE EN POLIETILENO TRANSPARENTE  
PACKAGING IN TRANSPARENT POLYETHYLENE



**-40°C / +120°C**  
**-40°F / +248°F**



# EASY LOCK / LN 135°

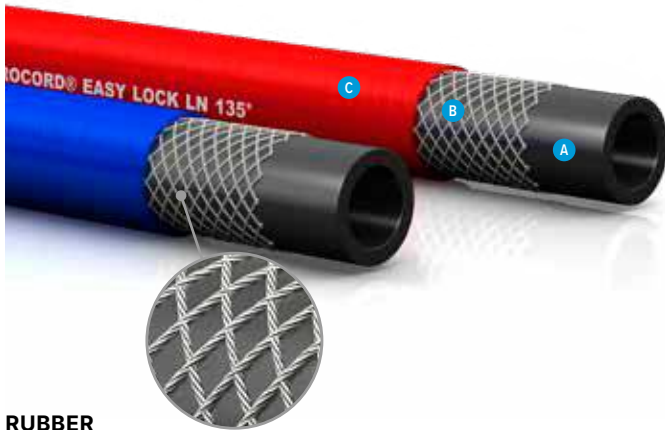

**RUBBER**



- Especialmente diseñada para sistemas de unión Push Lock. Suitable for Push Lock connection systems.



**USO APPLICATIONS**









Para entrega de agua caliente y fría y productos químicos ligeramente corrosivos. Especialmente adecuado para sistemas de unión Push Lock.

For delivery of hot and cold water and slightly corrosive chemical products. Suitable for Push Lock connection systems.



**ESTRUCTURA BODY**

<b>A</b> Capa interior Tube	Caucho sintético especial, resistente a las altas temperaturas. High temperature resistant special synthetic rubber.
<b>B</b> Refuerzos Reinforcement	1 trenza sintética, resistente a los aceites hidráulicos. 1 high tensile sythetic textile braid.
<b>C</b> Capa exterior Cover	Caucho especial rojo y azul resistente al aceite, al ozono, a la abrasión y a los agentes atmosféricos. Red and blue cover. Oil, abrasion ozone and weather resistant special synthetic rubber.
Superficie Surface	Lisa. Smooth.

 mm	 mm	 bar	 bar	 bar	 gr/mt	 mm	 m
4,8	10,7	34	136	-	90	50	>10
6,4	12,3	28	112	-	110	65	>10
8	13,9	28	112	-	130	80	>10
9,5	15,5	28	112	-	150	80	>10
12,7	19,5	28	112	-	220	100	>10
16	22,6	24	96	-	260	125	>10
19	25,8	21	84	-	310	150	>10
25,4	33,234	20	80	-	460	170	>10



**NORMAS NORMS:**  
SAE 100 R6 - ISO 1307 - EN854 TYPE R6 - TS6388  
EN854 TIP36 - ISO4079-1 R6

**MARCADOR MARKING:**  
EUROCORD® EASY LOCK LN 135°

**EMBALAJE BOX:**  
EMBALAJE EN POLIETILENO TRANSPARENTE  
PACKAGING IN TRANSPARENT POLYETHYLENE



**-40°C / +135°C**  
**-40°F / +275°F**

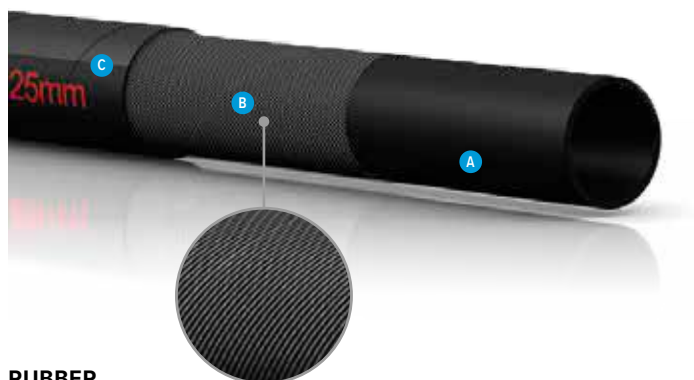

**RUBBER**



- **Ideal para el sector automovilístico y vehículos industriales.**  
Ideal for the automotive sector and for industrial vehicles.
- **También disponible en barras rectas de 1 m.**  
Available also in straight pieces (1 m).

**USO APPLICATIONS**

Adecuada para entrega de solución de agua caliente y líquido anticongelante. Se utiliza especialmente como conexión flexible en el circuito de refrigeración de los motores de automóvil.

Suitable for hot water and anti freeze liquid delivery. Particularly used like flexible connection on motors cooling systems.



**ESTRUCTURA BODY**

<b>A</b>	<b>Capa interior Tube</b>	Caucho EPDM de color negro. Heat, ozone and weather resistant, EPDM rubber.
<b>B</b>	<b>Refuerzos Reinforcement</b>	Textiles sintéticos. High tensile synthetic textile.
<b>C</b>	<b>Capa exterior Cover</b>	Caucho EPDM de color negro resistente a los agentes atmosféricos y al envejecimiento. Heat, ozone and weather resistant, EPDM rubber.
	<b>Superficie Surface</b>	Lisa con impresión de tela. Smooth with fabric impression.

mm	mm	bar	bar	bar	gr/mt	mm	m
18	24	4	12	-	281	180	40
20	26	4	12	-	307	200	40
22	28	4	12	-	334	220	40
25	32	4	12	-	423	250	40
28	36	4	12	-	573	280	40
30	38	4	12	-	609	300	40
32	40	4	12	-	645	320	40
35	43	4	12	-	699	350	40
38	46	4	12	-	753	380	40
40	48	4	12	-	789	400	40
42	50	4	12	-	825	420	40
45	54	4	12	-	990	450	40
48	57	4	12	-	1095	480	40
50	60	4	12	-	1200	510	40
55	65	4	12	-	1346	550	40
60	70	4	12	-	1493	600	40
65	75	4	12	-	1700	650	40
70	81	4	12	-	1906	700	20

**ABRAZADERAS Y COLLARES DE APRIETE RECOMENDADOS**  
**RECOMMENDED CLAMP/COLLAR**

STF - Abrazaderas de tornillo Hose clamps with screw (pag. 204-207)

SDB - Abrazaderas de tensión constante SAE Constant tension clamps SAE (pag. 215)

STC - Abrazaderas con perno Hose clamps with bolt (pag. 208-210)



**NORMAS** NORMS:  
ISO 1307  
**MARCADOR** MARKING:  
EUROCORD® RADIATOR HOT WATER 100°C  
**EMBALAJE** BOX:  
EMBALAJE EN POLIETILENO TRANSPARENTE  
PACKAGING IN TRANSPARENT POLYETHYLENE



**-40°C / +100°C**  
**-40°F / +212°F**

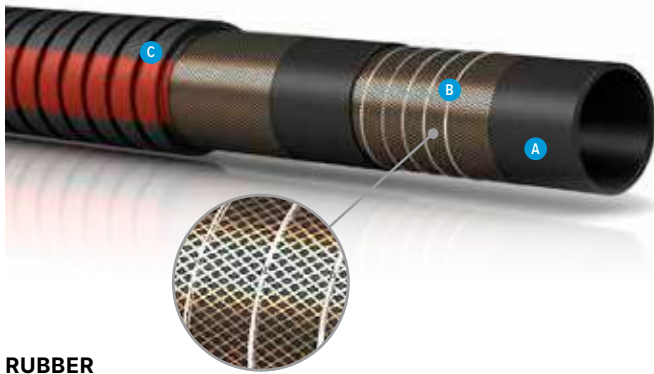

**RUBBER**



- **Ideal para el sector automovilístico y vehículos industriales.**  
Ideal for the automotive sector and for the industrial vehicles.



**USO APPLICATIONS**

Para la aspiración y entrega de aceites parafínicos, aire, agua y glicol. Especialmente adecuada para aplicaciones en las que se requieren pequeños radios de curvatura; se utiliza ampliamente en los sectores automovilístico y los vehículos industriales como manguera polivalente.

For paraffinic oils, air, water and glycol suction and delivery. Particularly used where it is necessary a small band radius. Suitable for the automotive sector and for the industrial vehicles.



**ESTRUCTURA BODY**

<b>A</b> <b>Capa interior Tube</b>	Caucho NBR negro resistente a aceites, óleo y carburantes, contenido aromático no superior al 50%. Oil and petrol resistant, black NBR, with aromatic content up to 50%.
<b>B</b> <b>Refuerzos Reinforcement</b>	Textiles sintéticos de alta tenacidad y espiral metálica incorporada, hilo de cobre. High tensile synthetic textile, steel wire helix and antistatic copper wire.
<b>C</b> <b>Capa exterior Cover</b>	Caucho EPDM. Oil, weather, ozone, abrasion resistant special synthetic rubber.
<b>Superficie Surface</b>	Acanalada en impresión en tela. Gretrato with fabric impression.



**ABRAZADERAS Y COLLARES DE APRIETE RECOMENDADOS**  
**RECOMMENDED CLAMP/COLLAR**

- STF - Abrazaderas de tornillo Hose clamps with screw (pag. 204-207)
- SDB - Abrazaderas de tensión constante SAE Constant tension clamps SAE (pag. 215)
- STC - Abrazaderas con perno Hose clamps with bolt (pag. 208-210)
- STS - Abrazaderas de tensión constante SAE Constant tension clamps SAE (pag. 214)



mm	mm	bar	bar	bar	gr/mt	mm	m
19	29	10	30	0,8	540	75	40
25	36	10	30	0,8	710	100	40
30	41	10	30	0,8	871	120	40
32	44	10	30	0,8	1014	130	40
35	46	10	30	0,8	993	140	40
38	49	10	30	0,8	1070	150	40
40	52	10	30	0,8	1249	160	40
45	57	10	30	0,8	1522	190	40
48	58	10	30	0,8	1314	200	40
51	63	10	30	0,8	1752	250	40
60	73	10	30	0,8	2132	310	40
70	83	10	30	0,8	2605	400	40
80	94	10	30	0,8	2983	475	20-40
90	104	10	30	0,8	3326	522	20
98	104	10	30	0,8	3326	522	20
100	117	10	30	0,8	4133	610	20-40
120	138	10	30	0,8	7400	720	20



**NORMAS** NORMS:  
ISO 1307  
**MARCADOR MARKING:**  
EUROCORD® OIL SUCTION DELIVERY HOSE W.P.  
10 BAR  
**EMBALAJE BOX:**  
EMBALAJE EN POLIETILENO NEGRO  
PACKAGING IN BLACK POLYETHYLENE



**-35°C / +100°C**  
**-31°F / +212°F**

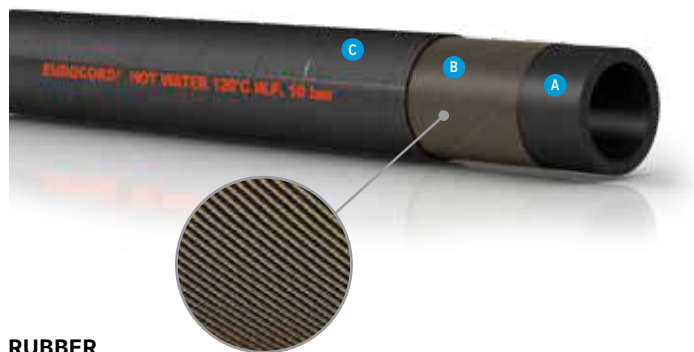

**RUBBER**

**USO APPLICATIONS**

Adecuada para agua caliente mezclada con vapor y fluidos calientes no corrosivos. Especialmente indicado para operaciones de limpieza y lavado con lanzas manuales y conexiones flexibles de calderas con termoconvertidores.

Suitable for delivery of hot water mixed with steam and non corrosive hot fluids. Particularly indicated for cleaning and washing operations with hand lances; as flexible connection hoses of boilers with thermoconverters.



**ESTRUCTURA BODY**

<b>A</b> Capa interior Tube	Lisa en caucho EPDM de color negro. EPDM rubber.
<b>B</b> Refuerzos Reinforcement	Textiles sintéticos. High tensile synthetic textile.
<b>C</b> Capa exterior Cover	Caucho EPDM de color negro resistente al calor, a los agentes atmosféricos y al envejecimiento. Heat, ozone and weather resistant, EPDM rubber.
Superficie Surface	Lisa con impresión de tela. Smooth with fabric impression.

mm	mm	bar	bar	bar	gr/mt	mm	m
10	20	10	30	-	346	100	40
12	22	10	30	-	392	120	40
13	23	10	30	-	415	130	40
15	25	10	30	-	461	150	40
16	26	10	30	-	484	160	40
17	27	10	30	-	507	170	40
18	28	10	30	-	529	180	40
20	30	10	30	-	575	200	40
22	32	10	30	-	621	225	40
25	35	10	30	-	667	250	40
28	38	10	30	-	736	280	40
30	41	10	30	-	897	300	40
32	45	10	30	-	1162	320	40
35	48	10	30	-	1260	350	40
38	51	10	30	-	1329	380	40
40	54	10	30	-	1423	400	40
45	61	10	30	-	1864	450	40
50	68	10	30	-	2231	510	40
60	82	10	30	-	3443	600	40

**ABRAZADERAS Y COLLARES DE APRIETE RECOMENDADOS RECOMMENDED CLAMP/COLLAR**

- STF - Abrazaderas de tornillo Hose clamps with screw (pag. 204-207)
- STC - Abrazaderas con perno Hose clamps with bolt (pag. 208-210)



**NORMAS NORMS:**  
ISO 1307

**MARCADOR MARKING:**  
EUROCORD® HOT WATER 120°C W.P. 10 BAR

**EMBALAJE BOX:**  
EMBALAJE EN POLIETILENO TRANSPARENTE  
PACKAGING IN TRANSPARENT POLYETHYLENE

**-40°C / +125°C**  
**-40°F / +257°F**





**RUBBER**



**USO  
APPLICATIONS**

Adecuada para entrega de vapor saturado. Especialmente utilizado en limpieza, lavado, esterilización, con lanzas de mano en industrias en general.

Particularly used in industrial cleaning and washing operations with hand lances.



- **Para entrega de vapor saturado.**  
For saturated steam delivery.



**ESTRUCTURA  
BODY**









<b>A</b> Capa interior Tube	Lisa en caucho EPDM de color negro. EPDM rubber, resistant to saturated steam.
<b>B</b> Refuerzos Reinforcement	Textiles sintéticos de alta resistencia. High tensile synthetic textile.
<b>C</b> Capa exterior Cover	Caucho EPDM de color negro resistente al calor, a los agentes atmosféricos y al envejecimiento. Heat, steam, ozone and weather resistant, pin-pricked special synthetic rubber.
<b>Superficie Surface</b>	Lisa con impresión de tela. Smooth with fabric impression.



**ABRAZADERAS Y COLLARES DE APRIETE  
RECOMENDADOS  
RECOMMENDED CLAMP/COLLAR**

STF - Abrazaderas de tornillo Hose clamps with screw (pag. 204-207)  
STC - Abrazaderas con perno Hose clamps with bolt (pag. 208-210)



 mm	 mm	 bar	 bar	 bar	 gr/mt	 mm	 m
12	23	6	60	-	320	127	40
15	26	6	60	-	387	150	40
18	30	6	60	-	485	180	40
19	31	6	60	-	511	190	40
25	37	6	60	-	604	254	40
30	45	6	60	-	958	300	40
32	46	6	60	-	914	320	40
35	50	6	60	-	1102	350	40
40	56	6	60	-	1339	400	40
45	64	6	60	-	1503	445	40
50	67	6	60	-	1638	508	40
60	82	6	60	-	1803	600	40



**NORMAS** NORMS:  
ISO 1307  
**MARCADOR** MARKING:  
EUROCORD® STEAM RESISTANT 160°C W.P. 6 BAR  
**EMBALAJE** BOX:  
EMBALAJE EN POLIETILENO TRANSPARENTE  
PACKAGING IN TRANSPARENT POLYETHYLENE



**-40°C / +165°C**  
**-40°F / +329°F**

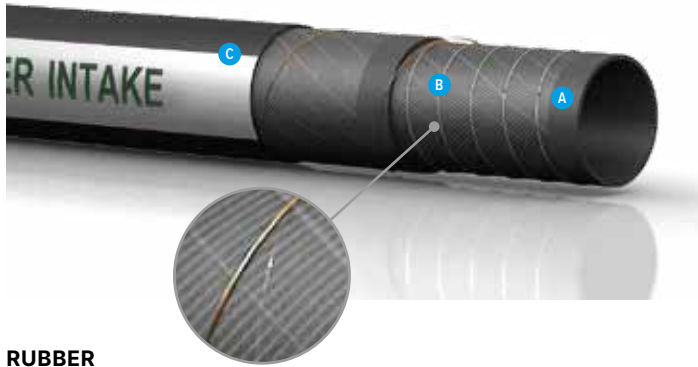

**RUBBER**

**USO APPLICATIONS**

Manguera adecuada para entrega y la aspiración de agua caliente. Puede conectarse como manguera para bombas de calor y autoclaves.

It can be connected like flexible for heat pumps or autoclaves.



**ESTRUCTURA BODY**

<b>A</b> Capa interior Tube	Caucho EPDM negro. EPDM rubber.
<b>B</b> Refuerzos Reinforcement	Textiles sintéticos de alta tenacidad. High tensile synthetic textile.
<b>C</b> Capa exterior Cover	Caucho EPDM resistente a la abrasión por calor y a los agentes atmosféricos. Abrasion, heat, steam, ozone and weather resistant, EPDM special synthetic rubber.
Superficie Surface	Lisa con impresión de tela. Smooth with fabric impression.

mm	mm	bar	bar	bar	gr/mt	mm	m
16	26	10	30	0,92	487	64	40-61
19	29	10	30	0,92	557	76	40-61
20	30	10	30	0,92	580	80	40-61
25	35	10	30	0,92	700	100	40-61
30	40	10	30	0,92	800	120	40-61
32	43	10	30	0,92	1000	128	40-61
35	46	10	30	0,92	1090	140	40-61
38	49	10	30	0,92	1200	152	40-61
40	51	10	30	0,92	1310	160	40-61
45	57	10	30	0,92	1610	180	40-61
50,8	63	10	30	0,92	1790	203	40-61
60	72	10	30	0,92	1986	270	40-61
70	82	10	30	0,92	2426	300	40-61
76	90	10	30	0,92	3075	300	40-61
80	94	10	30	0,92	3230	320	40-61
102	116	10	30	0,92	4050	400	40-61

**ABRAZADERAS Y COLLARES DE APRIETE RECOMENDADOS RECOMMENDED CLAMP/COLLAR**

STF - Abrazaderas de tornillo Hose clamps with screw (pag. 204-207)  
 STC - Abrazaderas con perno Hose clamps with bolt (pag. 208-210)



**NORMAS** NORMS:  
ISO 1307

**MARCADOR** MARKING:  
WATER INTAKE

**EMBALAJE** BOX:  
EMBALAJE DE POLIETILENO PÚRPURA  
PACKAGING IN PURPLE POLYETHYLENE

**-40°C / +125°C**  
**-40°F / +257°F**



**RUBBER**



**USO  
APPLICATIONS**

Adecuada para entrega de vapor saturado para la limpieza y esterilización de depósitos y tuberías.

For saturated steam delivery for cleaning services, tankers sterilization and piping systems.



**ESTRUCTURA  
BODY**

<b>A</b> Capa interior Tube	Caucho EPDM de color negro. EPDM rubber. Resistant to saturated steam.
<b>B</b> Refuerzos Reinforcement	Cordones metálicos de alta resistencia. High tensile steel wire cords.
<b>C</b> Capa exterior Cover	Caucho sintético de color rojo, resistente a la abrasión y a los agentes atmosféricos. Abrasion, heat, steam, oil, ozone and weather resistant. Pinpricked special synthetic rubber.
<b>Superficie Surface</b>	Lisa con impresión de tela microperforada. Smooth with microperforated fabric impression.











**ABRAZADERAS Y COLLARES DE APRIETE  
RECOMENDADOS  
RECOMMENDED CLAMP/COLLAR**

STF - Abrazaderas de tornillo Hose clamps with screw (pag. 204-207)  
STC - Abrazaderas con perno Hose clamps with bolt (pag. 208-210)



- Para entrega de vapor saturado.  
For Saturated steam delivery.
- También disponible en versión capa exterior de aceite según la normativa EN ISO6134 clase B.  
Available also with oil cover according to EN ISO6134 class B.



 mm	 mm	 bar	 bar	 bar	 gr/mt	 mm	 m
10	21	17	170	-	450	180	40
13	25	17	170	-	651	156	40
19	32	17	170	-	730	228	40
25	38	17	170	-	926	305	40
32	46	17	170	-	1612	386	40
38	54	17	170	-	2812	456	40
51	67	17	170	-	2419	610	40



**NORMAS** NORMS: ISO 1307  
**MARCADOR MARKING:**  
EUROCORD® STEAM RESISTANT 200°C W.P.17 BAR  
**EMBALAJE BOX:**  
EMBALAJE EN POLIETILENO TRANSPARENTE  
PACKAGING IN TRANSPARENT POLYETHYLENE



**-40°C / +208°C**  
**-40°F / +406°F**



# MANGUERAS PARA EL SUMINISTRO DE PRODUCTOS ALIMENTICIOS

FOOD DELIVERY HOSES







**RUBBER**



**USO  
APPLICATIONS**

Manguera para entrega a presión de agua caliente y líquidos ligeramente corrosivos, en equipos e instalaciones de diversos tipos. Especialmente utilizada como tubería flexible para la carga de lavavajillas industriales.

Particularly used like flexible hose for the loading of industrial dishwashers.



**ESTRUCTURA  
BODY**

<b>A</b> Capa interior Tube	Lisa, negra, a base de caucho sintético EPDM no tóxico. EPDM Atoxic rubber.
<b>B</b> Refuerzos Reinforcement	Textiles sintéticos. High tensile synthetic textile.
<b>C</b> Capa exterior Cover	Lisa en caucho EPDM de color negro resistente a la temperatura, la abrasión y los agentes atmosféricos. Abrasion, heat, ozone and weather resistant, smooth EPDM rubber.
Superficie Surface	Lisa. Smooth.



**ABRAZADERAS Y COLLARES DE APRIETE  
RECOMENDADOS  
RECOMMENDED CLAMP/COLLAR**

STF - Abrazaderas de tornillo Hose clamps with screw (pag. 204-207)  
SGT - Abrazaderas pinzables Stepp less (pag. 216)



- Fabricada según la normativa de la FDA título 21 partes 170 a 199 artículo 177.2600  
Produced according FDA-title 21 Parts 170 to 199 item 177.2600.



mm	mm	bar	bar	bar	gr/mt	mm	m
5	10,5	10	30	-	82	50	50-100
8	15	10	30	-	160	80	50-100
8	17	25	75	-	220	80	50-100
10	17	10	30	-	190	100	50-100
11	19	10	30	-	260	110	50-100
12	19,5	10	30	-	270	120	50-100
13	20	10	30	-	270	130	50-100



**NORMAS** NORMS:  
ISO 1307

**MARCADOR** MARKING:  
EUROCORD® EPDM FOOD QUALITY W.P. 10 BAR 100°C

**EMBALAJE** BOX:  
EMBALAJE EN POLIETILENO TRANSPARENTE  
PACKAGING IN TRANSPARENT POLYETHYLENE

**DECLARACIÓN DE CONFORMIDAD** DISPONIBLE  
DECLARATION OF COMPLIANCE IS AVAILABLE



**-30°C / +100°C**  
**-22°F / +212°F**

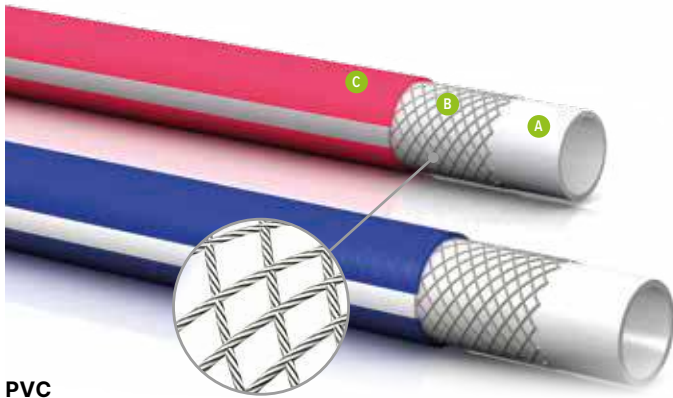

**PVC**

**USO APPLICATIONS**

Manguera para entrega a presión de agua caliente y líquidos ligeramente corrosivos, en equipos e instalaciones de diversos tipos. Especialmente utilizada como tubería flexible para la carga de lavavajillas industriales.

Flexible hose for the hot water and light corrosive liquids delivery. Suitable for equipment and plants in general. Particularly used like flexible hose for the loading of industrial dishwashers.



**ESTRUCTURA BODY**

<b>A</b> Capa interior Tube	PVC blanco no tóxico. Non-toxic white PVC, high tensile synthetic textile.
<b>B</b> Refuerzos Reinforcement	Refuerzo textil de alta tenacidad. High tensile synthetic textile.
<b>C</b> Capa exterior Cover	PVC resistente a los agentes atmosféricos, al ozono y a la abrasión. Abrasion, ozone and weather resistant special PVC compound.
Superficie Surface	Azul o rojo. Blue or red.

13	20	10	30	-	225	-	50-100

**ABRAZADERAS Y COLLARES DE APRIETE RECOMENDADOS RECOMMENDED CLAMP/COLLAR**

STF - Abrazaderas de tornillo Hose clamps with screw (pag. 204-207)  
SGT - Abrazaderas pinzables Stepp less (pag. 216)



**NORMAS NORMS:**  
ISO 1307, EU 10/2011  
**DECLARACIÓN DE CONFORMIDAD DISPONIBLE**  
DECLARATION OF COMPLIANCE IS AVAILABLE

**-10°C / +60°C**  
**+14°F / +140°F**



**RUBBER**



**USO  
APPLICATIONS**

Manguera adecuada para el paso de agua caliente en fábricas, producción de alimentos, mataderos o donde se requiera idoneidad para el contacto con alimentos.

Suitable for hot water delivery in food processing plants or abattoirs.



- Fabricada según la normativa de la FDA título 21 partes 170 a 199 artículo 177.2600  
Produced according FDA - title 21 Parts 170 to 199 item 177.2600.



**ESTRUCTURA  
BODY**









<b>A</b> Capa interior Tube	Caucho sintético de color blanco, grado alimentario según FDA (CFR 21 CAP. 177.2600) y 93/11EEC inodoro, apta para el paso de líquidos alimentarios. White synthetic rubber, food quality according to FDA (CFR 21 CAP. 177.2600) and 93/11/EEC, odorless, suitable for food liquids delivery.
<b>B</b> Refuerzos Reinforcement	Refuerzos de hilo sintético de alta resistencia. High tensile synthetic textile.
<b>C</b> Capa exterior Cover	Caucho sintético de color azul resistente a la abrasión, grasas animales, agentes atmosféricos y ozono. Abrasion, heat, ozone and weather resistant, smooth EPDM rubber.
Superficie Surface	Lisa. Smooth.



**ABRAZADERAS Y COLLARES DE APRIETE  
RECOMENDADOS  
RECOMMENDED CLAMP/COLLAR**

STF - Abrazaderas de tornillo Hose clamps with screw (pag. 204-207)  
SGT - Abrazaderas pinzables Stepp less (pag. 216)



 mm	 mm	 bar	 bar	 bar	 gr/mt	 mm	 m
13	23	15	45	-	400	60	100
16	26	15	45	-	460	85	50
19	30	15	45	-	600	100	50
25	36	15	45	-	780	125	50



**NORMAS** NORMS:  
ISO 1307

**MARCADOR MARKING:**  
EUROCORD® CLEANING LB W.P. 20 BAR  - 93/11EEC & FDA APPROVED

**EMBALAJE** BOX:  
EMBALAJE EN POLIETILENO TRANSPARENTE  
PACKAGING IN TRANSPARENT POLYETHYLENE

**DECLARACIÓN DE CONFORMIDAD DISPONIBLE**  
DECLARATION OF COMPLIANCE IS AVAILABLE



**-30°C / +90°C**  
con picos de hasta  
with peaks up to  
+110°C

**-22°F / +194°F**  
con picos de hasta  
with peaks up to  
+230°F



**RUBBER**



- **FDA apto para el paso de productos alimenticios acuosos.**  
Produced according FDA-title 21 Parts 170 to 199 item 177.2600.
- **Calidad alimentaria según BG VV XXI:2002 (kat.2) FDA inodoro.**  
Food quality according to BG VV XXI:2002 (kat.2) FDA odourless.

**USO APPLICATIONS**

Manguera apta para el paso de vapor y agua caliente. Suele utilizarse para lavar cobertizos, mataderos o cualquier entorno de trabajo. La capa exterior de color la hace resistente a las manchas.

For vapor and hot water transmission. Particularily used for cleaning in food processing plants (daires, abattoirs, etc.). Thanks to the coloured cover it is stain resistant.



**ESTRUCTURA BODY**

<b>A</b> Capa interior Tube	Caucho EPDM de color blanco de calidad alimentaria según la norma Bg VVV XXI:2002 (kat.2), FDA (CFR 21 § 177.2600) inodoro, apto para líquidos alimentarios, detergentes y vapor. White synthetic rubber, food quality according to FDA (CFR 21 CAP. 177.2600) and 93/11/EEC, odorless, suitable for food liquids delivery.
<b>B</b> Refuerzos Reinforcement	Textiles sintéticos de alta tenacidad. High tensile synthetic textile.
<b>C</b> Capa exterior Cover	Caucho EPDM de color azul con impresión de tela resistente a la abrasión, los agentes atmosféricos, el envejecimiento y el ozono. Oil, heat, abrasion, ozone and weather resistant, special synthetic rubber.
Superficie Surface	Lisa con impresión de tela. Smooth with fabric impression.

**ABRAZADERAS Y COLLARES DE APRIETE RECOMENDADOS RECOMMENDED CLAMP/COLLAR**

- STF - Abrazaderas de tornillo Hose clamps with screw (pag. 204-207)
- STC - Abrazaderas con perno Hose clamps with bolt (pag. 208-210)



mm	mm	bar	bar	bar	bar	gr/mt	mm	m
		steam	water					
13	23	6	18	60	-	-	130	40
16	26	6	18	60	-	-	160	40
19	31	6	18	60	-	-	190	40
25	37	6	18	60	-	-	250	40
32	47	6	18	60	-	-	320	40
38	54	6	18	60	-	-	380	40
51	66	6	18	60	-	-	510	40

**NORMAS NORMS:**  
ISO 1307

**MARCADOR MARKING:**  
EUROCORD® CLEANING STEAM 165°C  
ACCORDING FDA

**EMBALAJE BOX:**  
EMBALAJE EN POLIETILENO TRANSPARENTE  
PACKAGING IN TRANSPARENT POLYETHYLENE

**DECLARACIÓN DE CONFORMIDAD DISPONIBLE**  
DECLARATION OF COMPLIANCE IS AVAILABLE

**-40°C / +125°C**  
vapor hasta steam up to +165°C

**-40°F / +257°F**  
vapor hasta steam up to +329°F



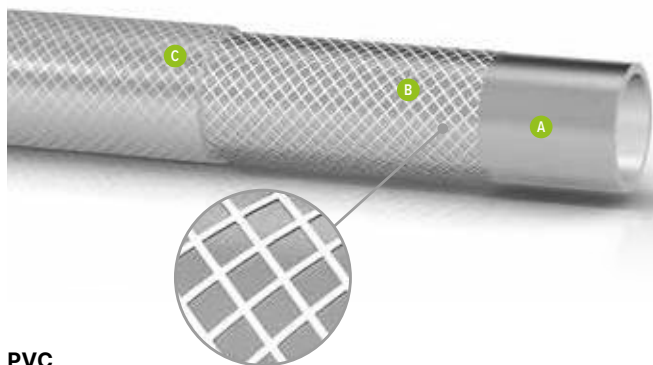

PVC



- Adecuada para entrega de líquidos alimentarios conforme con el Reglamento europeo n.º 10/2011 para los simulantes A-B-C. For the delivery of food liquids according to EU Regulation 10/2011 for A-B-C simulants.



## USO APPLICATIONS

Manguera polivalente apta para la impulsión de líquidos alimentarios conforme con el Reglamento europeo n.º 10/2011 para los simulantes A-B-C. Especialmente indicada para la industria alimentaria, vinícola, naval y astilleros.

Multipurpose food hose, suitable to the food liquids delivery according to EU Regulation 10/2011 for A-B-C simulants. Particularly used for the food industry, wine industry or marine industry.



## ESTRUCTURA BODY

<b>A</b>	Capa interior Tube	PVC transparente no tóxico. Non-toxic transparent PVC.
<b>B</b>	Refuerzos Reinforcement	Refuerzo textil de alta tenacidad. High tensile synthetic textile.
<b>C</b>	Capa exterior Cover	PVC transparente. Transparent PVC.
	Superficie Surface	Transparente. Transparent.



## ABRAZADERAS Y COLLARES DE APRIETE RECOMENDADOS RECOMMENDED CLAMP/COLLAR

STF - Abrazaderas de tornillo Hose clamps with screw (pag. 204-207)  
SGT - Abrazaderas pinzables Stepp less (pag. 216)



mm	mm	bar	bar	bar	gr/mt	mm	m
5	3,0	20	60	-	81	-	100
6	3,0	20	60	-	83	-	100
7	3,0	20	60	-	119	-	100
8	3,0	20	60	-	117	-	100
10	3,0	15	45	-	138	-	100
12	3,0	10	30	-	159	-	100
13	3,0	10	30	-	169	-	100
15	3,0	10	30	-	190	-	50
16	3,0	10	30	-	201	-	50
19	3,5	10	30	-	280	-	50
22	4,0	8	24	-	374	-	50
25	4,0	8	24	-	417	-	50
30	4,0	7	21	-	490	-	50
32	4,5	7	21	-	560	-	50
35	5,0	7	21	-	686	-	50
38	5,0	5	15	-	743	-	50
40	5,0	5	15	-	777	-	50
45	5,0	5	15	-	840	-	50
50	5,0	5	15	-	949	-	50



**NORMAS** NORMS:  
REG. UE 10/2011 FOR SIMULANT TYPE A-B-C  
ISO 1307  
**DECLARACIÓN DE CONFORMIDAD DISPONIBLE**  
DECLARATION OF COMPLIANCE IS AVAILABLE



**-5°C / +60°C**  
**+23°F / +140°F**

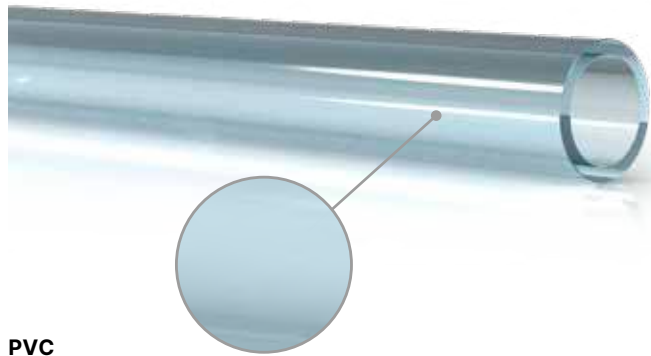

PVC



- **Adecuada para entrega de líquidos alimentarios conforme con el Reglamento europeo n.º 10/2011 para los simulantes A-B-C.**  
For the delivery of food liquids according to EU Regulation 10/2011 for A-B-C simulants.

**USO APPLICATIONS**

Manguera polivalente apta para la impulsión de líquidos alimentarios conforme con el Reglamento europeo n.º 10/2011 para los simulantes A-B-C. Especialmente indicada para la industria alimentaria, vinícola, naval y astilleros.

Multipurpose food hose, suitable to the food liquids delivery according to EU Regulation 10/2011 for A-B-C simulants. Particularly used for the food industry, wine industry or marine industry.



**ESTRUCTURA BODY**

<b>A</b>	<b>Material</b>	PVC transparente no tóxico. Non-toxic transparent PVC.
<b>B</b>	<b>Refuerzos</b> Reinforcement	---
<b>C</b>	<b>Capa exterior</b> Cover	PVC transparente. Transparent PVC.
	<b>Superficie</b> Surface	Azul transparente. Transparent light blue.

mm	mm	bar	bar	bar	gr/mt	mm	m
2	4	-	-	-	12	-	200
3	5	-	-	-	15	-	200
4	7	-	-	-	32	-	200
5	8	-	-	-	40	-	200
6	9	-	-	-	45	-	200
7	10	-	-	-	57	-	100
8	12	-	-	-	78	-	100
10	14	-	-	-	95	-	100
12	17	-	-	-	148	-	100
14	19	-	-	-	170	-	100
16	22	-	-	-	225	-	100
18	24	-	-	-	260	-	50
20	27	-	-	-	320	-	50
22	30	-	-	-	395	-	50
25	33	-	-	-	473	-	50
30	40	-	-	-	680	-	50

**ABRAZADERAS Y COLLARES DE APRIETE RECOMENDADOS**  
**RECOMMENDED CLAMP/COLLAR**

- STF - Abrazaderas de tornillo Hose clamps with screw (pag. 204-207)
- SGT - Abrazaderas pinzables Stepp less (pag. 216)
- SBS - Abrazaderas bifilares con resorte Double wire spring (pag. 217)



**NORMAS** NORMS:  
REG. UE 10/2011 FOR SIMULANT TYPE A-B-C  
ISO 1307  
**DECLARACIÓN DE CONFORMIDAD DISPONIBLE**  
DECLARATION OF COMPLIANCE IS AVAILABLE



**-5°C / +60°C**  
**+23°F / +140°F**

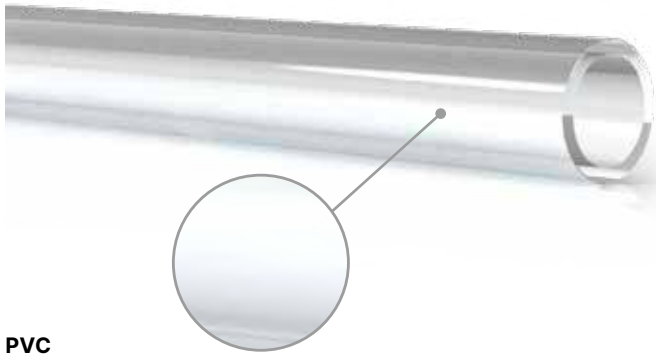

**PVC**



**USO  
APPLICATIONS**

Manguera de silicona transparente apta para entrega de líquidos alimentarios según la FDA (CFR 21 cap. 177.2600) cuando se requiere resistencia a altas temperaturas.

Transparent silicone hose suitable for the delivery of food liquids according to FDA (CFR 21 cap. 177.2600) where is necessary an high temperature resistance.



- **Resistencia a las altas temperaturas.**  
High temperature resistant.



**ESTRUCTURA  
BODY**

<b>A</b>	<b>Material</b>	Silicona no tóxica. Neutral non toxical silicone hose.
<b>B</b>	<b>Refuerzos</b> Reinforcement	---
<b>C</b>	<b>Capa exterior</b> Cover	Silicona translúcida. Translucent silicone.
	<b>Superficie</b> Surface	Transparente. Transparent.



**ABRAZADERAS Y COLLARES DE APRIETE  
RECOMENDADOS  
RECOMMENDED CLAMP/COLLAR**

- STF - Abrazaderas de tornillo Hose clamps with screw (pag. 204-207)
- SGT - Abrazaderas pinzables Stepp less (pag. 216)
- SBS - Abrazaderas bifilares con resorte Double wire spring (pag. 217)



mm	mm	bar	bar	bar	gr/mt	mm	m
2	4	-	-	-	12	-	100
3	5	-	-	-	16	-	100
3	6	-	-	-	27	-	100
4	6	-	-	-	20	-	100
4	7	-	-	-	32	-	100
4	8	-	-	-	48	-	100
5	8	-	-	-	39	-	100
5	9	-	-	-	56	-	100
6	8	-	-	-	56	-	100
6	9	-	-	-	45	-	100
6	10	-	-	-	64	-	100
6	12	-	-	-	108	-	100
7	10	-	-	-	51	-	50
7	11	-	-	-	72	-	50
8	12	-	-	-	80	-	50
9	12	-	-	-	63	-	50
10	14	-	-	-	96	-	50
12	16	-	-	-	112	-	50
12	18	-	-	-	180	-	50
14	18	-	-	-	126	-	50
15	20	-	-	-	176	-	50
18	24	-	-	-	253	-	25



**NORMAS** NORMS:  
REG. UE 10/2011 FOR SIMULANT TYPE A-B-C  
ISO 1307

**DECLARACIÓN DE CONFORMIDAD DISPONIBLE**  
DECLARATION OF COMPLIANCE IS AVAILABLE



**-60°C / +150°C**  
con picos de hasta  
with peaks up to  
+200°C

**-76°F / +302°F**  
con picos de hasta  
with peaks up to  
+392°F



PVC



- **Excelente entrega y aspiración de líquidos alimentarios.**  
Great suction and delivery of food liquids.
- **Versión superelástica.**  
Super elastic version.

**USO APPLICATIONS**

Adecuada para entrega y la aspiración de líquidos alimentarios conforme con el Reglamento europeo n.º 10/2011 para los simulantes A-B-C. Especialmente indicada en la industria alimentaria, la agricultura y la industria para acompañar a las bombas de aspiración.

For suction and delivery of food liquids according to EU Regulation 10/2011 for A-B-C simulants. Particularly used in the food, agricultural and industrial sectors in support of suction pumps.



**ESTRUCTURA BODY**

<b>A</b>	<b>Material</b>	PVC flexible. Strong, very flexible and smooth non-toxic, transparent plasticized PVC.
<b>B</b>	<b>Refuerzos Reinforcement</b>	Espiral de acero incorporada en la pared de la manguera. Steel wire spiral incorporated in hose wall.
<b>C</b>	<b>Capa exterior Cover</b>	PVC transparente. Transparent PVC.
	<b>Superficie Surface</b>	Lisa, transparente. Smooth, transparent.

mm	mm	bar	bar	bar	gr/mt	mm	m
10	3,1	12	-	0,9	180	23	60
12	3,1	12	-	0,9	190	24	60
14	3,1	12	-	0,9	230	28	60
16	3,1	12	-	0,9	260	32	60
18	3,5	11	-	0,9	296	28	60
20	3,5	10	-	0,9	340	30	60
22	3,7	10	-	0,9	400	33	60
25	4,0	10	-	0,9	520	38	60
30	4,2	9	-	0,9	630	45	60
32	4,2	9	-	0,9	660	48	30
35	4,3	9	-	0,9	750	52	30
38	4,5	9	-	0,9	800	57	30
40	4,8	9	-	0,9	950	60	30
45	4,9	9	-	0,9	1150	67	30
50	5,4	7	-	0,9	1300	75	30
60	6,0	6	-	0,9	1750	120	30
63	6,1	6	-	0,9	1800	130	30
70	6,7	5	-	0,9	2100	140	30
80	6,3	4	-	0,8	2500	160	30
90	6,5	4	-	0,8	2900	180	30
100	7,5	3	-	0,8	3650	200	30
110	7,0	3	-	0,8	3950	220	20
120	8,0	3	-	0,8	4300	240	20
125	8,0	3	-	0,8	4600	250	20

**ABRAZADERAS Y COLLARES DE APRIETE RECOMENDADOS**  
**RECOMMENDED CLAMP/COLLAR**

- STF - Abrazaderas de tornillo Hose clamps with screw (pag. 204-207)
- STC - Abrazaderas con perno Hose clamps with bolt (pag. 208-210)

**NORMAS** NORMS:  
 REG. UE 10/2011 FOR SIMULANT TYPE A-B-C  
 ISO 1307

**DECLARACIÓN DE CONFORMIDAD DISPONIBLE**  
 DECLARATION OF COMPLIANCE IS AVAILABLE

**-5°C / +60°C**  
**+23°F / +140°F**





PVC



**USO  
APPLICATIONS**

Manguera universal en PVC apta para entrega y aspiración óptima de líquidos alimentarios conforme al Reglamento europeo n.º 10/2011 para los simulantes A-B-C. La espiral metálica la hace extremadamente flexible y la transparencia permite ver el paso del líquido.

Universal pvc hose suitable for suction and delivery of food liquids according to EU Regulation 10/2011 for A-B-C simulants. The steel wire spiral makes it extremely flexible and the transparency lets see the liquid passage.



**ESTRUCTURA  
BODY**

<b>A</b>	<b>Material</b>	PVC flexible. Strong, very flexible and smooth non-toxic, transparent plasticized PVC.
<b>B</b>	<b>Refuerzos</b>	Espirales de acero incorporada en la pared de la manguera. Steel wire spiral incorporated in hose wall.
<b>C</b>	<b>Capa exterior</b>	PVC transparente. Transparent PVC.
	<b>Superficie</b>	Lisa, transparente. Smooth, transparent.



**ABRAZADERAS Y COLLARES DE APRIETE  
RECOMENDADOS  
RECOMMENDED CLAMP/COLLAR**

STF - Abrazaderas de tornillo Hose clamps with screw (pag. 204-207)  
STC - Abrazaderas con perno Hose clamps with bolt (pag. 208-210)



- **Excelente entrega y aspiración de líquidos alimentarios.**  
Great suction and delivery of food liquids.
- **Manguera universal.**  
Universal hose.



mm	mm	bar	bar	bar	gr/mt	mm	m
10	3,0	7	-	0,85	160	20	60/30
12	3,0	7	-	0,85	180	25	60/30
13	3,0	6	-	0,85	190	27	60/30
14	3,0	6	-	0,85	200	30	60/30
16	3,1	6	-	0,85	225	35	60/30
18	3,1	6	-	0,85	280	40	60/30
19	3,1	5	-	0,85	310	42	60/30
20	3,1	5	-	0,85	340	50	60/30
22	3,2	5	-	0,85	370	55	60/30
25	3,2	5	-	0,85	510	60	60/30
30	3,5	4	-	0,85	600	70	60/30
32	3,9	4	-	0,85	650	75	30
35	4,2	4	-	0,85	730	80	30
38	4,4	4	-	0,85	800	90	30
40	4,5	3	-	0,85	870	95	30
45	5,1	3	-	0,8	1100	105	30
50/51	5,1	3	-	0,8	1200	125	30
60	6,5	2,5	-	0,7	1800	135	30
63	6,5	2,5	-	0,7	1950	150	30
63	6,5	2,5	-	0,7	2000	140	30
70	7	2	-	0,7	2200	180	30
75	7	2	-	0,7	2500	195	30
80	7,5	2	-	0,7	2700	220	30
90	7,5	2	-	0,6	3000	260	30
102	8	2	-	0,6	3400	300	30



**NORME** NORMES :  
REG. UE 10/2011 FOR SIMULANT TYPE A-B-C  
ISO 1307

DECLARACIÓN DE CONFORMIDAD DISPONIBLE  
DECLARATION OF COMPLIANCE IS AVAILABLE



**-5°C / +60°C**  
**+23°F / +140°F**

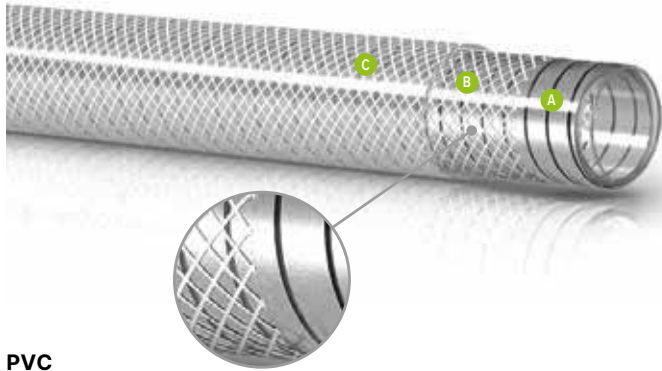

PVC



- **Conforme con el Reglamento europeo n.º 10/2011 para los simulantes A-B-C-D1. Accordant to EU Regulation 10/2011 for A-B-C-D1 simulants.**

**USO APPLICATIONS**

Adecuada para entrega y la aspiración máxima de líquidos inertes o productos alimenticios conforme con el Reglamento europeo n.º 10/2011 para los simulantes A-B- C-D1. Especialmente indicada para la industria alimentaria, vinícola, naval y astilleros.

For suction and maximum delivery of the food liquids delivery according to EU Regulation 10/2011 for A-B-C-D1 simulants. Particularly used for the food industry, wine industry or marine industry.



**ESTRUCTURA BODY**

<b>A</b>	<b>Material</b>	PVC flexible. Flexible PVC.
<b>B</b>	<b>Refuerzos Reinforcement</b>	Espiral metálica incorporada y refuerzos textiles sintéticas. Steel spiral and synthetic textile reinforcement.
<b>C</b>	<b>Capa exterior Cover</b>	PVC transparente. Transparent PVC.
	<b>Superficie Surface</b>	Ligeramente corrugada. Slightly corrugated.

mm	mm	bar	bar	bar	gr/mt	mm	m
19	28	14	42	0,8	450	80	60
25	35,5	14	42	0,8	670	90	60
30	40,6	14	42	0,8	770	105	60
32	42,5	14	42	0,8	800	110	60
35	48	12	36	0,8	1100	125	60
38	51	12	36	0,8	1150	135	30
40	53	12	36	0,8	1200	140	30
45	58	10	30	0,8	1400	155	30
50	63	10	30	0,8	1600	170	30

**ABRAZADERAS Y COLLARES DE APRIETE RECOMENDADOS RECOMMENDED CLAMP/COLLAR**

- STF - Abrazaderas de tornillo Hose clamps with screw (pag. 204-207)
- STC - Abrazaderas con perno Hose clamps with bolt (pag. 208-210)



**NORME NORMES :**  
REG. UE 10/2011 FOR SIMULANT TYPE A-B-C-D1  
ISO 1307

**DECLARACIÓN DE CONFORMIDAD DISPONIBLE  
DECLARATION OF COMPLIANCE IS AVAILABLE**

**-5°C / +60°C  
+23°F / +140°F**

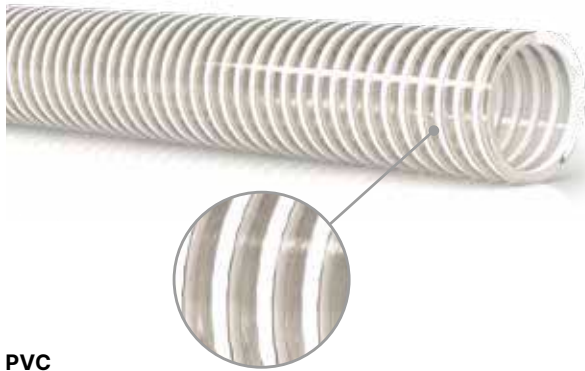

PVC



- **Conforme con el Reglamento europeo n.º 10/2011 para los simulantes A-B-C.**  
Accordant to EU Regulation 10/2011 for A-B-C simulants.



**USO**  
**APPLICATIONS**

Adecuada para entrega y la aspiración de líquidos alimentarios conforme con el Reglamento europeo n.º 10/2011 para los simulantes A-B-C. Especialmente indicada en la industria alimentaria, la agricultura y la industria para acompañar a las bombas de aspiración.

For suction and delivery of food liquids according to EU Regulation 10/2011 for A-B-C simulants. Particularly used in the food, agricultural and industrial sectors in support of suction pumps.



**ESTRUCTURA**  
**BODY**

<b>A</b>	<b>Material</b>	PVC flexible. Strong, flexible, and smooth non-toxic plasticized PVC.
<b>B</b>	<b>Refuerzos</b> Reinforcement	Espiral blanca antichoque. Shock resistant PVC spiral.
<b>C</b>	<b>Capa exterior</b> Cover	PVC transparente. Transparent PVC.
	<b>Superficie</b> Surface	Ligeramente corrugada. Slightly corrugated.

mm	mm	bar	bar	bar	gr/mt	mm	m
20	2,4	-	23	-	195	80	50
25	2,5	-	21	-	230	100	50
30	2,8	-	19	-	280	120	50
32	2,8	-	18	-	290	128	50
35	3,5	-	17	-	380	140	50
38	3,2	-	17	-	420	152	50
40	3,3	-	16	-	470	160	50
45	3,3	-	15	-	530	180	50
50	3,6	-	14	-	640	200	50
60	3,6	-	12	-	800	240	50



**ABRAZADERAS Y COLLARES DE APRIETE**  
**RECOMENDADOS**  
**RECOMMENDED CLAMP/COLLAR**

- STF - Abrazaderas de tornillo Hose clamps with screw (pag. 204-207)
- STC - Abrazaderas con perno Hose clamps with bolt (pag. 208-210)
- SSS - Abrazadera de salto espiral Spiral piepe clamp (pag. 219)



**NORMAS** NORMS:  
REG. UE 10/2011 FOR SIMULANT TYPE A-B-C  
ISO 1307  
**DECLARACIÓN DE CONFORMIDAD DISPONIBLE**  
DECLARATION OF COMPLIANCE IS AVAILABLE



**-5°C / +60°C**  
**+23°F / +140°F**

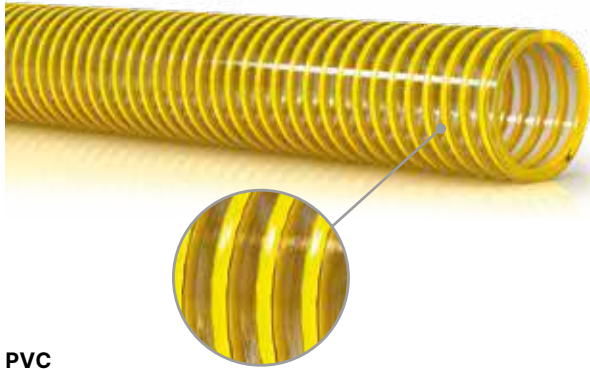

PVC



- **Conforme con el Reglamento europeo n.º 10/2011 para los simulantes A-B-C.**  
Accordant to EU Regulation 10/2011 for A-B-C simulants.



**USO APPLICATIONS**

Adecuada para entrega y la aspiración de líquidos alimentarios conforme con el Reglamento europeo n.º 10/2011 para los simulantes A-B-C. Especialmente indicada en la industria alimentaria, la agricultura y la industria para acompañar a las bombas de aspiración.

For suction and delivery of food liquids according to EU Regulation 10/2011 for A-B-C simulants. Particularly used in the food, agricultural and industrial sectors in support of suction pumps.



**ESTRUCTURA BODY**

<b>A</b>	<b>Material</b>	PVC flexible. Strong, flexible, and smooth non-toxic plasticized PVC.
<b>B</b>	<b>Refuerzos Reinforcement</b>	Espiral amarilla antichoque. Shock resistant PVC spiral.
<b>C</b>	<b>Capa exterior Cover</b>	PVC transparente. Transparent PVC.
	<b>Superficie Surface</b>	Ligeramente corrugada. Slightly corrugated.



**ABRAZADERAS Y COLLARES DE APRIETE RECOMENDADOS**  
**RECOMMENDED CLAMP/COLLAR**

- STF - Abrazaderas de tornillo Hose clamps with screw (pag. 204-207)
- STC - Abrazaderas con perno Hose clamps with bolt (pag. 208-210)



mm	mm	bar	bar	bar	gr/mt	mm	m
20	2,7	-	28	0,8	240	85	50
25	2,9	-	22	0,8	300	112	50
30	3,1	-	21	0,8	345	135	50
32	3,2	-	20	0,8	370	144	50
35	3,2	-	19	0,8	415	157	50
38	3,3	-	18	0,8	470	171	50
40	3,5	-	18	0,8	505	180	50
45	3,5	-	17	0,8	570	202	50
50	3,8	-	15	0,8	690	225	50
60	4,0	-	13	0,7	825	270	50
70	4,5	-	12	0,7	1080	315	50
75	4,6	-	12	0,7	1260	337	50
80	4,8	-	12	0,6	1400	360	50
90	5,1	-	11	0,6	1620	405	25
100	5,9	-	11	0,6	1850	459	25
110	6,1	-	11	0,5	2250	495	25
120	6,3	-	10	0,4	2700	540	25
125	6,6	-	10	0,4	2880	562	25
150	7,0	-	9	0,3	3870	675	25
200	8,5	-	7	0,2	5950	900	10



**NORMAS** NORMS:  
REG. UE 10/2011 FOR SIMULANT TYPE A-B-C  
ISO 1307  
**DECLARACIÓN DE CONFORMIDAD DISPONIBLE**  
DECLARATION OF COMPLIANCE IS AVAILABLE



**-5°C / +60°C**  
**+23°F / +140°F**



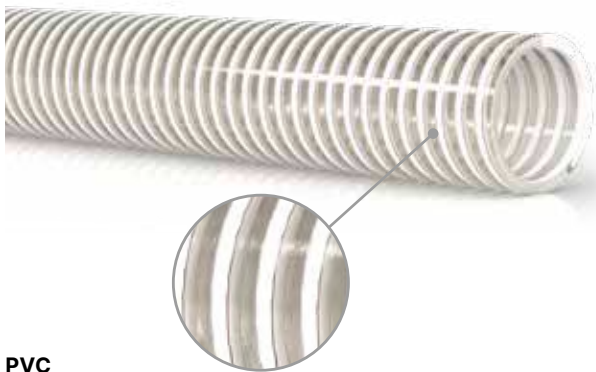

PVC



- **Conforme con el Reglamento europeo n.º 10/2011 para los simulantes A-B-C.**  
Accordant to EU Regulation 10/2011 for A-B-C simulants.



**USO  
APPLICATIONS**

Adecuada para entrega y la aspiración de líquidos alimentarios conforme con el Reglamento europeo n.º 10/2011 para los simulantes A-B-C. Especialmente indicada en la industria alimentaria, la agricultura y la industria para acompañar a las bombas de aspiración.

For suction and delivery of food liquids according to EU Regulation 10/2011 for A-B-C simulants. Particularly used in the food, agricultural and industrial sectors in support of suction pumps.



**ESTRUCTURA  
BODY**

<b>A</b>	<b>Material</b>	PVC flexible. Strong, flexible, and smooth non-toxic plasticized PVC.
<b>B</b>	<b>Refuerzos</b>	Espiral blanca antichoque. Shock resistant PVC spiral.
<b>C</b>	<b>Capa exterior</b>	PVC transparente. Transparent PVC.
	<b>Superficie</b>	Ligeramente corrugada. Slightly corrugated.



**ABRAZADERAS Y COLLARES DE APRIETE  
RECOMENDADOS  
RECOMMENDED CLAMP/COLLAR**

STF - Abrazaderas de tornillo Hose clamps with screw (pag. 204-207)  
STC - Abrazaderas con perno Hose clamps with bolt (pag. 208-210)



mm	mm	bar	bar	bar	gr/mt	mm	m
20	3,0	-	25	0,8	300	90	50
25	3,2	-	24	0,8	350	110	50
30	3,4	-	21	0,8	440	125	50
32	3,5	-	21	0,8	460	130	50
35	3,6	-	20	0,8	520	140	50
38	3,9	-	19	0,8	570	155	50
40	4,0	-	19	0,8	590	165	50
45	4,0	-	19	0,8	670	195	50
50	4,3	-	16	0,8	830	215	50
60	4,7	-	15	0,7	950	260	50
70	4,9	-	13	0,7	1150	310	50
80	5,1	-	13	0,6	1530	350	50
90	5,3	-	13	0,6	1750	415	25
100	5,5	-	12	0,6	2150	450	25



**NORMAS** NORMS:  
REG. UE 10/2011 FOR SIMULANT TYPE A-B-C  
ISO 1307  
**DECLARACIÓN DE CONFORMIDAD DISPONIBLE**  
DECLARATION OF COMPLIANCE IS AVAILABLE



**-5°C / +60°C**  
**+23°F / +140°F**



PVC



- **Conforme con el Reglamento europeo n.º 10/2011 para los simulantes A-B-C.**  
**Accordant to EU Regulation 10/2011 for A-B-C simulants.**
- **Versión antiestática.**  
**Antistatic compound.**

**USO APPLICATIONS**

Adecuada para entrega y la aspiración de líquidos alimentarios conforme con el Reglamento europeo n.º 10/2011 para los simulantes A-B-C. Especialmente indicada en la industria alimentaria, la agricultura y la industria para acompañar a las bombas de aspiración. Versión antiestática con hilo de cobre para disipar la electricidad estática.

For suction and delivery of food liquids according to EU Regulation 10/2011 for A-B-C simulants. Particularly used in the food, agricultural and industrial sectors in support of suction pumps. Antistatic version with copper wire for static electricity dissipation.



**ESTRUCTURA BODY**

<b>A</b>	<b>Material</b>	PVC flexible. Strong, flexible, and smooth non-toxic plasticized PVC.
<b>B</b>	<b>Refuerzos Reinforcement</b>	Espiral blanca antichoque. Shock resistant PVC spiral.
<b>C</b>	<b>Capa exterior Cover</b>	PVC transparente. Transparent PVC.
	<b>Superficie Surface</b>	Ligeramente corrugada. Slightly corrugated.

mm	mm	bar	bar	bar	gr/mt	mm	m
20	3,0	-	25	0,8	300	90	50
25	3,2	-	24	0,8	350	110	50
30	3,4	-	21	0,8	440	125	50
32	3,5	-	21	0,8	460	130	50
35	3,6	-	20	0,8	520	140	50
38	3,9	-	19	0,8	570	155	50
40	4,0	-	19	0,8	590	165	50
45	4,0	-	19	0,8	670	195	50
50	4,3	-	16	0,8	830	215	50
60	4,7	-	15	0,7	950	260	50
70	4,9	-	13	0,7	1150	310	50
80	5,1	-	13	0,6	1530	350	50
90	5,3	-	13	0,6	1750	415	25
100	5,5	-	12	0,6	2150	450	25

**ABRAZADERAS Y COLLARES DE APRIETE RECOMENDADOS RECOMMENDED CLAMP/COLLAR**

- STF - Abrazaderas de tornillo Hose clamps with screw (pag. 204-207)
- STC - Abrazaderas con perno Hose clamps with bolt (pag. 208-210)



**NORMAS** NORMS:  
 REG. UE 10/2011 FOR SIMULANT TYPE A-B-C  
 ISO 1307

**DECLARACIÓN DE CONFORMIDAD DISPONIBLE**  
 DECLARATION OF COMPLIANCE IS AVAILABLE

**-5°C / +60°C**  
**+23°F / +140°F**

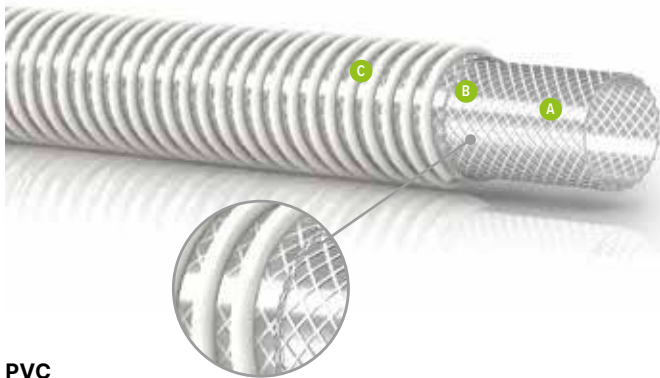

PVC



- **Conforme con el Reglamento europeo n.º 10/2011 para los simulantes A-B-C.-D1. Accordant to EU Regulation 10/2011 for A-B-C-D1 simulants.**



**USO APPLICATIONS**

Adecuada para entrega y la aspiración máxima de líquidos inertes o productos alimenticios conforme con el Reglamento europeo n.º 10/2011 para los simulantes A-B- C-D1. Especialmente indicada para la industria alimentaria, vinícola, naval y astilleros.

For suction and maximum delivery of the food liquids delivery according to EU Regulation 10/2011 for A-B-C-D1 simulants. Particularly used for the food industry, wine industry or marine industry.



**ESTRUCTURA BODY**

<b>A</b>	<b>Capa interior Tube</b>	PVC flexible. Flexible PVC.
<b>B</b>	<b>Refuerzos Reinforcement</b>	Espiral blanca antichoque y refuerzos textiles sintéticas. Shock resistant PVC spiral and synthetic textile reinforcement.
<b>C</b>	<b>Capa exterior Cover</b>	PVC transparente. Transparent PVC.
	<b>Superficie Surface</b>	Ligeramente corrugada. Slightly corrugated.

mm	mm	bar	bar	bar	gr/mt	mm	m
38	50	7,5	23	0,95	630	64	50
40	54	7,5	21	0,95	700	70	50
51	66	7	21	0,95	1100	100	50
60	75	7	21	0,9	1250	120	50
63	78	7	21	0,9	1400	130	50
76	92	7	21	0,9	1680	150	50
80	97	7	18	0,9	2100	160	50
102	121	5,5	16	0,9	2590	200	25
127	151	5	15	0,8	4000	265	25
152	181	5	15	0,8	5680	330	25
203	231	4	12	0,7	7450	450	25



**ABRAZADERAS Y COLLARES DE APRIETE RECOMENDADOS RECOMMENDED CLAMP/COLLAR**

STF - Abrazaderas de tornillo Hose clamps with screw (pag. 204-207)  
STC - Abrazaderas con perno Hose clamps with bolt (pag. 208-210)



**NORMAS** NORMS:  
REG. UE 10/2011 FOR SIMULANT TYPE A-B-C-D1  
ISO 1307  
**DECLARACIÓN DE CONFORMIDAD DISPONIBLE**  
DECLARATION OF COMPLIANCE IS AVAILABLE



**-25°C / +60°C**  
**+13°F / +140°F**

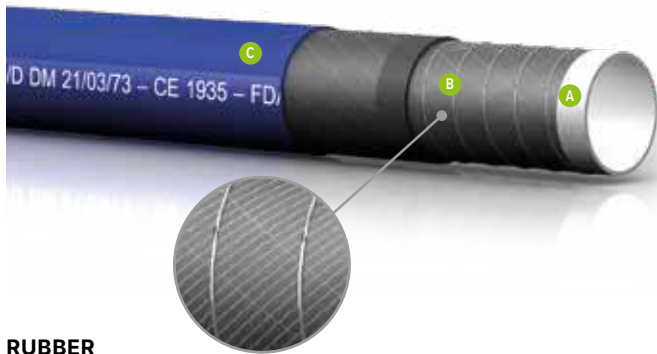

**RUBBER**



- **Fabricada según la normativa DM 21/03/73 - CE 1935 - FDA -3° - LIBRE DE BFR-FTALATOS.**  
Produced according norms DM 21/03/73 - CE 1935 - FDA -3° - BFR - PHTALATES FREE.
- **Adecuada para la aspiración y entrega de aceite de olivo.**  
For suction and delivery of olive oil.
- **Adecuada para la aspiración y entrega de leche y productos alimenticios grasos.**  
For suction and delivery of milk and fatty foodstuff.











**USO APPLICATIONS**

Para la aspiración y entrega de aceite de olivo y productos alimenticios grasos (leche, etc.).

Mandrel built food hose suitable for suction and delivery of olive oil and fatty foodstuffs (milk, etc.).

**ESTRUCTURA BODY**

<b>A</b> <b>Capa interior Tube</b>	Lisa en caucho NBR blanco de calidad alimentaria resistente a las grasas vegetales y animales. White NBR rubber, resistant to vegetable oils and animal fats.
<b>B</b> <b>Refuerzos Reinforcement</b>	Espiral de acero armónico galvanizado incorporada entre refuerzos de fibra sintética de alta resistencia. High tensile textile plies and galvanized steel helix wire.
<b>C</b> <b>Capa exterior Cover</b>	Caucho azul resistente a la abrasión, las grasas vegetales, los agentes atmosféricos y el ozono. Blue, smooth rubber, vegetable fats resistant, abrasion, ozone and weather resistant.
<b>Superficie Surface</b>	Lisa con impresión de tela. Smooth with fabric impression.

 mm	 mm	 bar	 bar	 bar	 gr/mt	 mm	 m
19	29	10	30	0,9	0,50	57	20/40/60
25	35	10	30	0,9	0,65	75	20/40/60
30	40	10	30	0,9	0,74	90	20/40/60
32	42	10	30	0,9	0,80	96	20/40/60
35	45	10	30	0,9	0,85	105	20/40/60
38	49	10	30	0,9	0,95	114	20/40/60
40	50	10	30	0,9	0,98	120	20/40/60
51	62	10	30	0,9	1,30	153	20/40/60
60	72	10	30	0,9	1,50	180	20/40/60
70	82	10	30	0,8	2,10	280	20/40/60
76	89	10	30	0,8	2,35	300	20/40/60
80	94	10	30	0,8	2,45	320	20/40/60
90	103	5	15	0,8	3,00	360	20/40/60
102	115	5	15	0,8	3,40	400	20/40/60
120	136	5	15	0,8	4,70	480	20/40/60
125	141	5	15	0,8	4,85	500	20/40/60

**NORMAS NORMS:**  
F.D.A, 3° SANITARY STANDARDS AND WITH BFR RECOMMENDATIONS XXI CAT.2, REG CE 1935/04 AND 2023/06 DM 21/03/73. FREE FROM PHTALATES - BPA - BISPHENOL A F.D.A - 3-A

**MARCADOR MARKING:**  
EUROCORD® ULTRAFOOD MULTIPURPOSE S/D DM 21/03/73 - CE 1935 - FDA - 3° - BFR - PHTALATES FREE

**DECLARACIÓN DE CONFORMIDAD DISPONIBLE**  
DECLARATION OF COMPLIANCE IS AVAILABLE

**-20°C / +90°C**  
**-4°F / +194°F**



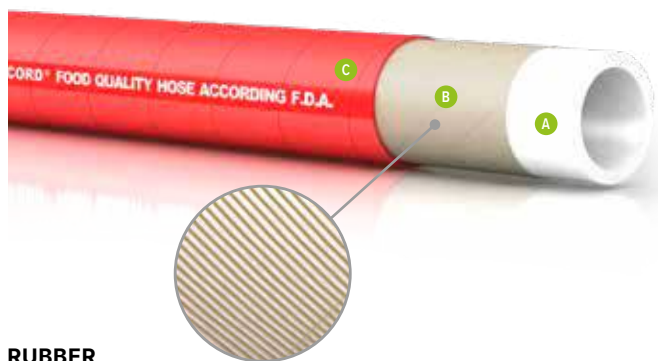

**RUBBER**



**USO APPLICATIONS**

Para entrega de agua potable, vinos, licores, zumos de fruta, refrescos y líquidos alimentarios no grasos. Conforme con las normas del D.M. 21/3/73.

For suction and delivery of beverages such as wine, liqueur, beer, fruit juices, mineral water, etc. DM 21/3/73 norms approved.



**ESTRUCTURA BODY**

<b>A</b>	<b>Capa interior Tube</b>	Lisa en caucho blanco de grado alimentario EPDM/SBR/NR, diseñada para garantizar la absoluta no toxicidad e inalterabilidad del sabor y aroma del producto, conforme con la normativa F.D.A. título 21 - artículo 177.2600. White colour, non-toxic, taste and odour free EPDM/SBR NR rubber, according to FDA title 21 - item 177.2600.
<b>B</b>	<b>Refuerzos Reinforcement</b>	Fibras sintéticas de alta resistencia. High tensile synthetic textile.
<b>C</b>	<b>Capa exterior Cover</b>	Caucho rojo (EPDM/SBR/NR) resistente a la abrasión, a los agentes atmosféricos y al ozono. Weather, ozone and abrasion resistant, special synthetic rubber.
	<b>Superficie Surface</b>	Lisa con impresión de tela. Smooth with fabric impression.



**ABRAZADERAS Y COLLARES DE APRIETE RECOMENDADOS RECOMMENDED CLAMP/COLLAR**

STF - Abrazaderas de tornillo Hose clamps with screw (pag. 204-207)  
STC - Abrazaderas con perno Hose clamps with bolt (pag. 208-210)



- **Garantiza la absoluta no toxicidad e inalterabilidad de los productos alimenticios.**  
It guarantees the absolute non-toxicity and the inalterability of food products.



mm	mm	bar	bar	bar	gr/mt	mm	m
13	-	10	30	-	-	130	40
16	-	10	30	-	-	160	40
18	-	10	30	-	-	180	40
19	-	10	30	-	-	190	40
25	-	10	30	-	-	250	40
30	-	10	30	-	-	300	40
32	-	10	30	-	-	320	40
35	-	10	30	-	-	350	40
38	-	10	30	-	-	380	40
40	-	10	30	-	-	400	40
45	-	10	30	-	-	450	40
51	-	10	30	-	-	510	40
60	-	10	30	-	-	600	40
70	-	10	30	-	-	700	40
80	-	10	30	-	-	800	40/20
102	-	10	30	-	-	1020	20



**NORMAS NORMS:**  
ISO 1307  
**MARCADOR MARKING:**  
EUROCORD® FOOD QUALITY HOSE ACCORDING F.D.A  
**EMBALAJE BOX:**  
EMBALAJE EN POLIETILENO TRANSPARENTE  
PACKAGING IN TRANSPARENT POLYETHYLENE  
**DECLARACIÓN DE CONFORMIDAD DISPONIBLE**  
DECLARATION OF COMPLIANCE IS AVAILABLE



**-40°C / +120°C**  
**-40°F / +248°F**

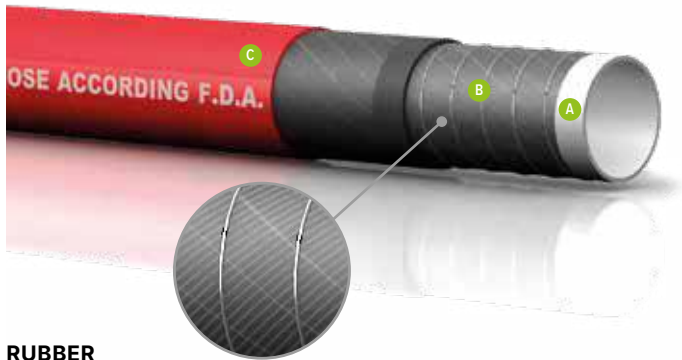

**RUBBER**



- **Garantiza la absoluta no toxicidad e inalterabilidad de los productos alimenticios.**  
It guarantees the absolute non-toxicity and the inalterability of food products.

**USO APPLICATIONS**

Para entrega de agua potable, vinos, licores, zumos de fruta, refrescos y líquidos alimentarios no grasos. Conforme con las normas del D.M. 21/3/73.

For suction and delivery of beverages such as wine, liqueur, beer, fruit juices, mineral water, etc. DM 21/3/73 norms approved.



**ESTRUCTURA BODY**

<b>A</b> Capa interior Tube	Lisa en caucho blanco de grado alimentario EPDM/SBR/NR, diseñada para garantizar la absoluta no toxicidad e inalterabilidad del sabor y aroma del producto, conforme con la normativa F.D.A. título 21 - artículo 177.2600. White colour, non-toxic, taste and odour free EPDM/SBR NR rubber, according to FDA title 21 - item 177.2600.
<b>B</b> Refuerzos Reinforcement	Espiral metálica y fibras textiles sintéticas de alta tenacidad. High tensile synthetic textile.
<b>C</b> Capa exterior Cover	Caucho rojo (EPDM/SBR/NR) resistente a la abrasión, a los agentes atmosféricos y al ozono. Weather, ozone and abrasion resistant, special synthetic rubber.
<b>Superficie Surface</b>	Lisa con impresión de tela. Smooth with fabric impression.

**ABRAZADERAS Y COLLARES DE APRIETE RECOMENDADOS RECOMMENDED CLAMP/COLLAR**

- STF - Abrazaderas de tornillo Hose clamps with screw (pag. 204-207)
- STC - Abrazaderas con perno Hose clamps with bolt (pag. 208-210)



mm	mm	bar	bar	bar	gr/mt	mm	m
19	-	10	30	0,7	-	95	40
25	-	10	30	0,7	-	125	40
30	-	10	30	0,7	-	150	40
32	-	10	30	0,7	-	160	40
35	-	10	30	0,7	-	175	40
38	-	10	30	0,7	-	190	40
40	-	10	30	0,7	-	200	40
45	-	10	30	0,7	-	225	40
51	-	10	30	0,7	-	250	40
60	-	10	30	0,7	-	300	40
70	-	10	30	0,7	-	350	40
80	-	10	30	0,7	-	400	40/20
90	-	10	30	0,7	-	450	40/20
102	-	10	30	0,7	-	500	20
110	-	10	30	0,7	-	550	20
120	-	10	30	0,7	-	600	20

**NORMAS NORMS:**  
ISO 1307

**MARCADOR MARKING:**  
EUROCORD® FOOD QUALITY HOSE ACCORDING F.D.A.

**EMBALAJE BOX:**  
EMBALAJE EN POLIETILENO TRANSPARENTE  
PACKAGING IN TRANSPARENT POLYETHYLENE

**DECLARACIÓN DE CONFORMIDAD DISPONIBLE**  
DECLARATION OF COMPLIANCE IS AVAILABLE

**-40°C / +120°C**  
**-40°F / +248°F**

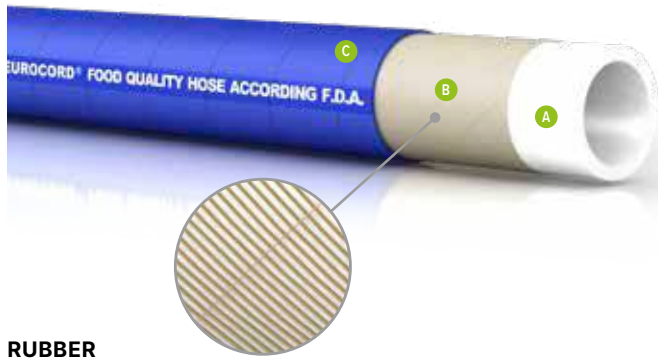

**RUBBER**



**USO  
APPLICATIONS**

Adecuada para entrega de líquidos alimentarios grasos: leche y sus derivados, aceites, grasas animales y vegetales, etc.

For delivery of vegetable and fatty foods and liquids



- Especialmente indicada para la industria alimentaria, la agricultura y la industria en general, acoplada con bombas de aspiración. Specific for the delivery of fatty food liquids.



**ESTRUCTURA  
BODY**









<b>A</b>	<b>Capa interior Tube</b>	Lisa en caucho sintético de color blanco no tóxico resistente a los productos que contienen grasa, conforme con la normativa F.D.A. - TÍTULO 21- ARTÍCULO 177.2600. White, non-toxic, taste and odour free, vegetable oil resistant, food grade NBR rubber.
<b>B</b>	<b>Refuerzos Reinforcement</b>	Textiles sintéticos de alta resistencia. High tensile synthetic textile.
<b>C</b>	<b>Capa exterior Cover</b>	Caucho azul (EPDM/SBR/NR) resistente a la abrasión, a los agentes atmosféricos y al ozono. Oil weather, ozone and abrasion resistant, special synthetic rubber.
	<b>Superficie Surface</b>	Lisa con impresión de tela. Smooth with fabric impression.



**ABRAZADERAS Y COLLARES DE APRIETE  
RECOMENDADOS  
RECOMMENDED CLAMP/COLLAR**

- STF - Abrazaderas de tornillo Hose clamps with screw (pag. 204-207)
- STC - Abrazaderas con perno Hose clamps with bolt (pag. 208-210)



 mm	 mm	 bar	 bar	 bar	 gr/mt	 mm	 m
13	-	10	30	-	-	130	40
16	-	10	30	-	-	160	40
19	-	10	30	-	-	200	40
25	-	10	30	-	-	250	40
30	-	10	30	-	-	300	40
32	-	10	30	-	-	320	40
35	-	10	30	-	-	350	40
38	-	10	30	-	-	380	40
40	-	10	30	-	-	400	40
45	-	10	30	-	-	450	40
51	-	10	30	-	-	510	40
60	-	10	30	-	-	600	40
70	-	10	30	-	-	700	40
80	-	10	30	-	-	800	40-20
102	-	10	30	-	-	1020	20
120	-	10	30	-	-	1200	20



**NORMAS** NORMS:  
ISO 1307

**MARCADOR** MARKING:  
EUROCORD® FOOD QUALITY HOSE ACCORDING F.D.A.

**EMBALAJE** BOX:  
EMBALAJE EN POLIETILENO TRANSPARENTE  
PACKAGING IN TRANSPARENT POLYETHYLENE

**DECLARACIÓN DE CONFORMIDAD DISPONIBLE**  
DECLARATION OF COMPLIANCE IS AVAILABLE



**-40°C / +80°C**  
**-40°F / +176°F**

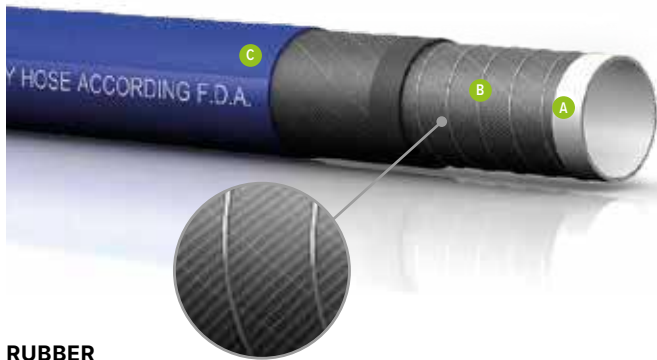

**RUBBER**



- Especialmente indicada para la industria alimentaria, la agricultura y la industria en general, acoplada con bombas de aspiración. Specific for the delivery of fatty food liquids.

**USO APPLICATIONS**

Adecuada para entrega y la aspiración de líquidos alimentarios grasos: leche y sus derivados, aceites, grasas animales y vegetales, etc.

For suction and delivery of vegetable and fatty foods and liquids.



**ESTRUCTURA BODY**

<b>A</b> Capa interior Tube	Lisa en caucho sintético de color blanco no tóxico resistente a los productos que contienen grasa, conforme con la normativa F.D.A. - TÍTULO 21- ARTÍCULO 177.2600. White, non-toxic, taste and odour free, vegetable oil resistant, food grade NBR rubber.
<b>B</b> Refuerzos Reinforcement	Textiles sintéticos de alta resistencia y espiral de metal. High tensile synthetic textile and steel wire helix.
<b>C</b> Capa exterior Cover	Caucho azul (EPDM/SBR/NR) resistente a la abrasión, a los agentes atmosféricos y al ozono. Weather, ozone and abrasion resistant, special synthetic rubber.
Superficie Surface	Lisa con impresión de tela. Smooth with fabric impression.

mm	mm	bar	bar	bar	gr/mt	mm	m
19	-	10	30	0,7	-	95	40
25	-	10	30	0,7	-	120	40
30	-	10	30	0,7	-	150	40
32	-	10	30	0,7	-	150	40
35	-	10	30	0,7	-	175	40
38	-	10	30	0,7	-	200	40
40	-	10	30	0,7	-	210	40
51	-	10	30	0,7	-	250	40
60	-	10	30	0,7	-	360	40
76	-	10	30	0,7	-	450	40
80	-	10	30	0,7	-	480	40-20
102	-	10	30	0,7	-	600	20

**ABRAZADERAS Y COLLARES DE APRIETE RECOMENDADOS RECOMMENDED CLAMP/COLLAR**

- STF - Abrazaderas de tornillo Hose clamps with screw (pag. 204-207)
- STC - Abrazaderas con perno Hose clamps with bolt (pag. 208-210)



**NORMAS NORMS:**  
ISO 1307

**MARCADOR MARKING:**  
EUROCORD® FOOD QUALITY HOSE ACCORDING F.D.A.

**EMBALAJE BOX:**  
EMBALAJE EN POLIETILENO TRANSPARENTE  
PACKAGING IN TRANSPARENT POLYETHYLENE

**DECLARACIÓN DE CONFORMIDAD DISPONIBLE  
DECLARATION OF COMPLIANCE IS AVAILABLE**

**-40°C / +80°C  
-40°F / +176°F**



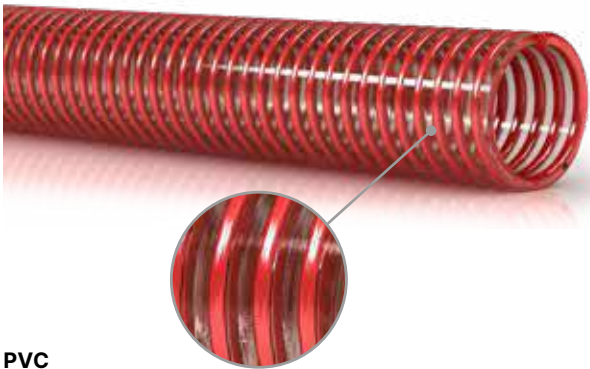

PVC



- **Excepcionalmente resistente a los impactos y al uso intensivo.**  
Extremely resistant to shock and heavy duty use.



**USO APPLICATIONS**

Adecuada para entrega y la aspiración de líquidos alimentarios conforme con el Reglamento europeo n.º 10/2011 para los simulantes A-B-C. Especialmente indicada en la industria alimentaria, la agricultura y la industria para acompañar a las bombas de aspiración.

Suitable for suction and delivery of food liquids according to EU Regulation 10/2011 for A-B-C simulants. Particularly used for the food, agricultural, insutrial sectors in support of suction pumps.



**ESTRUCTURA BODY**

<b>A</b>	<b>Material</b>	PVC plastificado no tóxico, resistente, flexible y liso. Strong, flexible, and smooth non-toxic plasticized PVC.
<b>B</b>	<b>Refuerzos Reinforcement</b>	Espiral roja antichoque. Shock resistant PVC spiral.
<b>C</b>	<b>Capa exterior Cover</b>	PVC transparente, resistente a la abrasión. Crushing, abrasion and weather resistant, light corrugated outside.
	<b>Superficie Surface</b>	Lisa. Smooth.

mm	mm	bar	bar	bar	gr/mt	mm	m
20	3	-	28	0,9	335	100	50
25	3	-	24	0,9	400	125	50
30	3,5	-	21	0,9	535	150	50
32	3,5	-	21	0,9	580	160	50
35	3,7	-	21	0,9	630	175	50
38	3,7	-	21	0,9	680	190	50
40	3,7	-	21	0,9	710	200	50
45	4,2	-	21	0,9	815	225	50
51	5	-	17	0,95	1165	300	50
60	5,5	-	17	0,95	1550	360	50
63	5,6	-	17	0,95	1700	378	50
70	5,7	-	14	0,95	1845	420	50
76	6	-	14	0,95	1940	450	50
80	6,4	-	14	0,95	2135	480	50
90	6,7	-	14	0,95	2425	540	25
102	7,2	-	12	0,95	3200	600	25
110	7,7	-	12	0,9	3590	660	25
120	7,8	-	12	0,9	3880	720	25
152	8,7	-	10,5	0,9	6100	900	25



**ABRAZADERAS Y COLLARES DE APRIETE RECOMENDADOS**  
RECOMMENDED CLAMP/COLLAR

STC - Abrazaderas con perno Hose clamps with bolt (pag. 208-210)



**NORMAS** NORMS:  
REG. UE 10/2011 FOR SIMULANT TYPE A-B-C  
ISO 1307  
**DECLARACIÓN DE CONFORMIDAD DISPONIBLE**  
DECLARATION OF COMPLIANCE IS AVAILABLE



**-5°C / +60°C**  
**+23°F / +140°F**

# MANGUERAS CON ESPIRAL PARA ASPIRACIÓN DE AIRE, VENTILACIÓN Y AIRE ACONDICIONADO



VACUUM AND CONDITIONING SPIRAL  
PVC HOSES

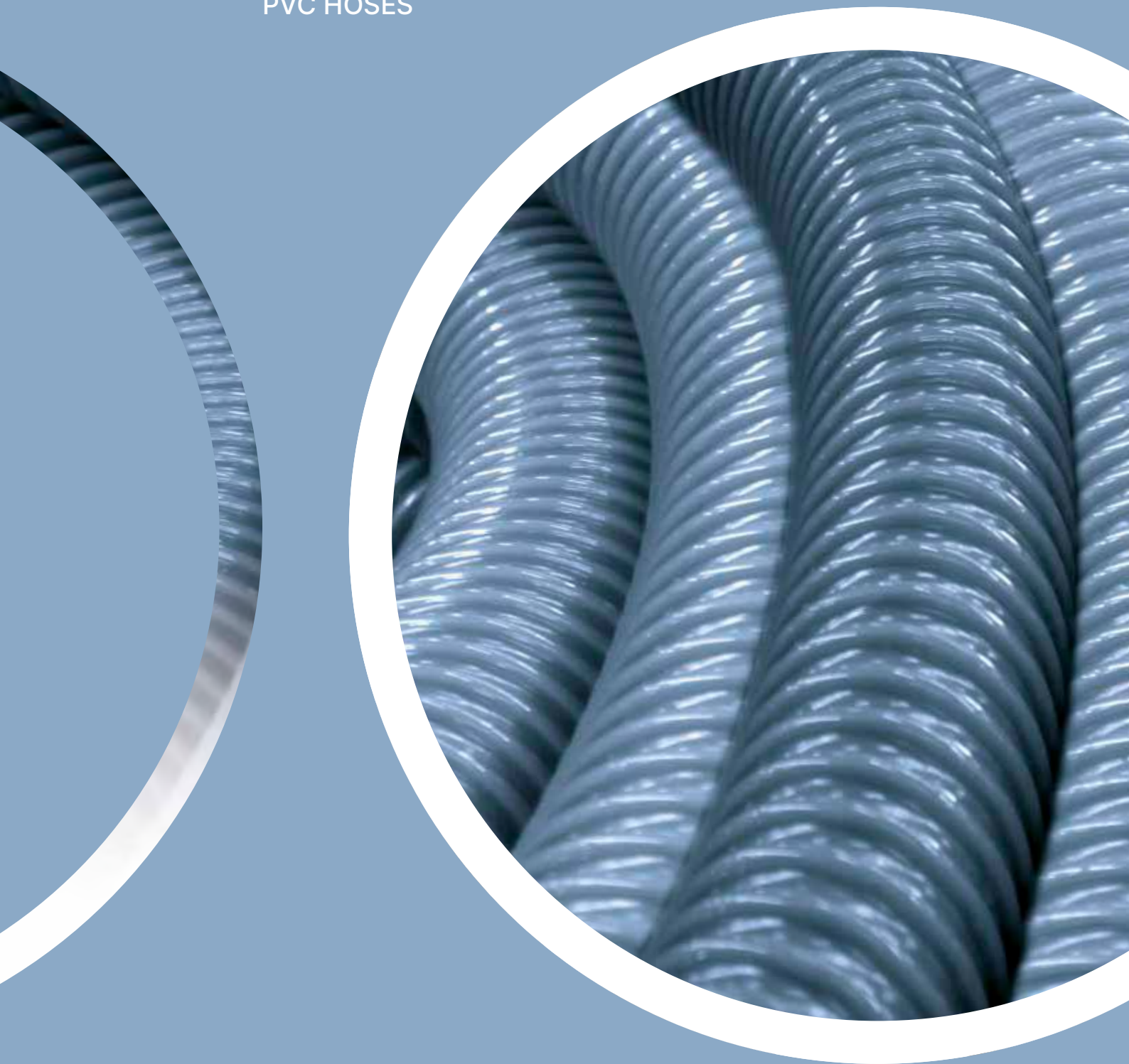

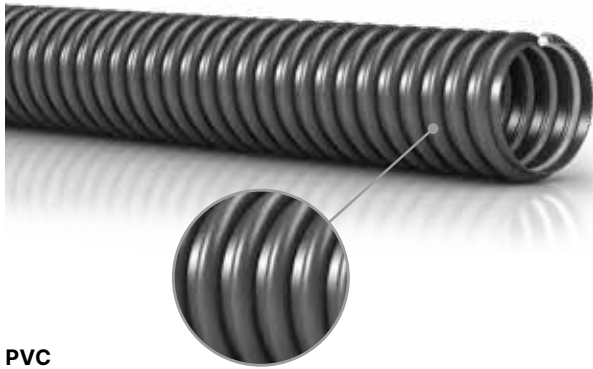

PVC



**USO  
APPLICATIONS**

Adecuada para la aspiración y el paso de aire, humos, polvo, virutas y filamentos. Especialmente indicada en las industrias textil, cerámica y maderera.

Suitable for the industrial ventilation and airflow systems, for dust, air, gases, powders. Particularly used in the textile, ceramic and wood industries.



- **Excelente para las industrias textil, cerámica y maderera.**  
Great for the textile, ceramic and wood industries.



**ESTRUCTURA  
BODY**

<b>A</b>	<b>Material</b>	PVC extremadamente ligero y flexible. Extremely light and flexible plasticized PVC.
<b>B</b>	<b>Refuerzos</b>	Espiral de PVC antichoques. Shock resistant PVC spiral.
<b>C</b>	<b>Capa exterior</b>	PVC gris resistente al ozono y a los agentes atmosféricos. Crushing, chemical agents, abrasion and weather resistant.
	<b>Superficie</b>	Corrugada. Outside corrugated.



**ABRAZADERAS Y COLLARES DE APRIETE  
RECOMENDADOS  
RECOMMENDED CLAMP/COLLAR**

- STF - Abrazaderas de tornillo Hose clamps with screw (pag. 204-207)
- STC - Abrazaderas con perno Hose clamps with bolt (pag. 208-210)
- SSS - Abrazadera de salto espiral Spiral piepe clamp (pag. 219)



mm	mm	bar	bar	bar	gr/mt	mm	m
20	24,8	1	-	0,5	115	28	30
25	30	0,5	-	0,5	165	35	30
30	35,2	0,5	-	0,5	215	42	30
32	38	0,5	-	0,5	225	45	30
35	41	0,5	-	0,5	235	47	30
38	44,2	0,5	-	0,5	255	50	30
40	46,5	0,5	-	0,5	270	55	30
45	52,2	0,5	-	0,5	350	60	30
50	57	0	-	0,45	435	65	30
60	68	0	-	0,45	525	80	30
70	78,4	0	-	0,45	620	95	30
75	84	0	-	0,4	670	100	30
80	89	0	-	0,4	755	110	30
90	99	0	-	0,4	805	125	30
100	110	0	-	0,4	950	140	30
110	120,4	0	-	0,4	1065	150	30
120	131	0	-	0,35	1165	170	30
127	138	0	-	0,35	1210	173	30
130	141	0	-	0,35	1240	175	30
140	151	0	-	0,35	1455	190	30
150	162	0	-	0,35	1650	200	30
160	172	0	-	0,3	1800	220	20
180	193	0	-	0,3	2130	250	20
200	214	0	-	0,3	2330	280	20
250	264	0	-	0,3	3240	300	10
300	316	0	-	0,3	3980	330	10



**NORME NORMS:**  
ISO 1307



**-5°C / +60°C**  
**+23°F / +140°F**



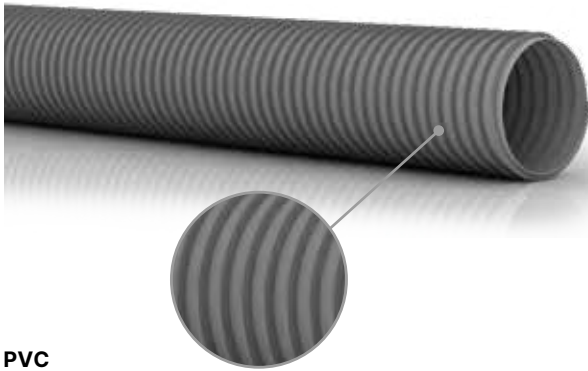

PVC



- **Excelente para las industrias textil, cerámica y maderera.**  
Great for the textile, ceramic and wood industries.

**USO APPLICATIONS**

Adecuada para la aspiración y el paso de aire, humos, polvo ligeramente abrasivo, virutas y filamentos. Especialmente indicada en las industrias textil, cerámica y maderera.

Suitable for the industrial ventilation and airflow systems, for dust, air, gases, powders. Particularly used in the textile, ceramic and wood industries.



**ESTRUCTURA BODY**

<b>A</b>	<b>Material</b>	PVC ligero y flexible. Extremely light and flexible plasticized PVC.
<b>B</b>	<b>Refuerzos Reinforcement</b>	Espiral de PVC antichoques. Shock resistant PVC spiral.
<b>C</b>	<b>Capa exterior Cover</b>	PVC gris resistente al ozono y a los agentes atmosféricos. Crushing, chemical agents, abrasion and weather resistant.
	<b>Superficie Surface</b>	Corrugada. Outside corrugated.

mm	mm	bar	bar	bar	gr/mt	mm	m
20	26	2	-	0,6	115	20	30
25	31,6	2	-	0,55	155	25	30
30	36,6	2	-	0,55	210	30	30
32	39	1,5	-	0,55	230	32	30
35	43	1,5	-	0,55	260	35	30
38	46	1,5	-	0,55	300	38	30
40	49	1,5	-	0,55	320	40	30
45	53	1,5	-	0,5	395	45	30
50	59	1,5	-	0,5	485	50	30
60	71	1,5	-	0,5	580	60	30
70	81	1,5	-	0,5	680	70	30
75	86	1,5	-	0,5	755	75	30
80	92	1,5	-	0,5	870	80	30
90	103	1,5	-	0,5	1020	90	30
100	124	1	-	0,5	1210	100	30
110	125	1	-	0,45	1360	110	30
120	135	1	-	0,45	1455	120	30
125	140	1	-	0,45	1550	125	30
130	144	1	-	0,45	1650	130	30
140	154	1	-	0,45	1800	140	30
150	164	1	-	0,4	1965	150	30
160	175	0,5	-	0,3	2280	160	20
180	195	0,5	-	0,3	2500	180	20
203	220	0,5	-	0,2	3055	203	20
250	270	0,25	-	0,15	3900	250	10
300	325	0,25	-	0,1	5500	300	10

**ABRAZADERAS Y COLLARES DE APRIETE RECOMENDADOS**  
**RECOMMENDED CLAMP/COLLAR**

- STF - Abrazaderas de tornillo Hose clamps with screw (pag. 204-207)
- STC - Abrazaderas con perno Hose clamps with bolt (pag. 208-210)
- SSS - Abrazadera de salto espiral Spiral piepe clamp (pag. 219)



**NORME NORMS:**  
ISO 1307

**-15°C / +65°C**  
**+5°F / +149°F**



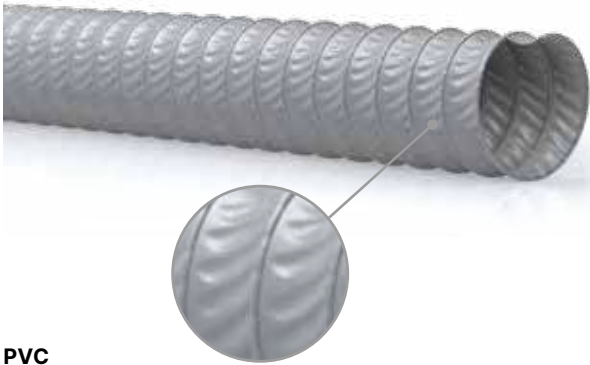

PVC



**USO  
APPLICATIONS**

Manguera extremadamente flexible y ligera, adecuada para ventilación mecánica que conecta respiraderos y difusores.

Extremely light and flexible hose for ventilation and air conditioning.



**ESTRUCTURA  
BODY**

<b>A</b>	<b>Material</b>	Tejido de poliéster recubierto de resinas poliolefinicas aditivadas. Polyester hose with resins polyolefin with additives.
<b>B</b>	<b>Refuerzos</b> Reinforcement	Espiral helicoidal de alambre de acero armónico. Helical spiral in harmonic steel wire.
<b>C</b>	<b>Capa exterior</b> Cover	Corrugada. Outside corrugated.
	<b>Superficie</b> Surface	Gris metalizado. Metallic grey.



**ABRAZADERAS Y COLLARES DE APRIETE  
RECOMENDADOS  
RECOMMENDED CLAMP/COLLAR**

STF - Abrazaderas de tornillo Hose clamps with screw (pag. 204-207)

STC - Abrazaderas con perno Hose clamps with bolt (pag. 208-210)



- **Flexibilidad y ligereza extremas.**  
Extremely flexible and light.



mm	mm	bar	bar	bar	gr/mt	mm	m
51	-	-	-	-	-	0,6 x Di	10
63	-	-	-	-	-	0,6 x Di	10
70	-	-	-	-	-	0,6 x Di	10
80	-	-	-	-	-	0,6 x Di	10
89	-	-	-	-	-	0,6 x Di	10
102	-	-	-	-	-	0,6 x Di	10
110	-	-	-	-	-	0,6 x Di	10
121	-	-	-	-	-	0,6 x Di	10
127	-	-	-	-	-	0,6 x Di	10
133	-	-	-	-	-	0,6 x Di	10
140	-	-	-	-	-	0,6 x Di	10
152	-	-	-	-	-	0,6 x Di	10
160	-	-	-	-	-	0,6 x Di	10
180	-	-	-	-	-	0,6 x Di	10
203	-	-	-	-	-	0,6 x Di	10
254	-	-	-	-	-	0,6 x Di	10
305	-	-	-	-	-	0,6 x Di	10
356	-	-	-	-	-	0,6 x Di	10
406	-	-	-	-	-	0,6 x Di	10
457	-	-	-	-	-	0,6 x Di	10



**COMPRESIBILIDAD AXIAL**  
AXIAL COMPRIMIBILITY:  
8:1



**-20°C / +90°C**  
con picos de hasta  
with peaks up to  
+100°C  
  
**-4°F / +194°F**  
con picos de hasta  
with peaks up to  
+212°F

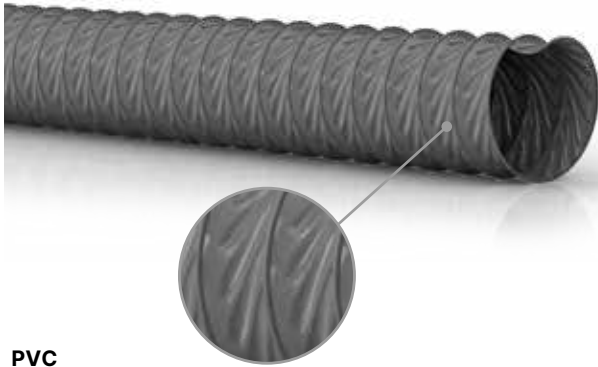

PVC



- **Flexibilidad y ligereza extremas.**  
Extremely flexible and light.

**USO APPLICATIONS**

Manguera extremadamente flexible y ligera. Adecuado para el paso de aire, humos y polvo; especialmente indicado para la climatización naval y civil.

Extremely light and flexible hose for the ventilation and air conditioning. Suitable for air, dust, fumes passage.



**ESTRUCTURA BODY**

<b>A</b>	<b>Material</b>	Tejido de poliamida recubierto por dos caras en PVC. Polyamide fabric, coated on two sides of PVC.
<b>B</b>	<b>Refuerzos Reinforcement</b>	Espiral de acero armónico recubierta en PVC incorporada. Harmonic steel incorporated spiral, coated of PVC.
<b>C</b>	<b>Capa exterior Cover</b>	Corrugada. Outside corrugated.
	<b>Superficie Surface</b>	Gris oscuro metalizado. Metallic dark grey.

mm	mm	bar	bar	bar	gr/mt	mm	m
40	-	0,90	-	0,24	120	0,7 x Di	10
45	-	0,80	-	0,20	130	0,7 x Di	10
50	-	0,80	-	0,20	145	0,7 x Di	10
60	-	0,80	-	0,16	170	0,7 x Di	10
65	-	0,70	-	0,14	182	0,7 x Di	10
70	-	0,70	-	0,14	198	0,7 x Di	10
80	-	0,60	-	0,10	227	0,7 x Di	10
90	-	0,50	-	0,09	254	0,7 x Di	10
100	-	0,50	-	0,09	285	0,7 x Di	10
110	-	0,50	-	0,08	310	0,7 x Di	10
120	-	0,50	-	0,08	342	0,7 x Di	10
125	-	0,40	-	0,08	356	0,7 x Di	10
130	-	0,40	-	0,08	370	0,7 x Di	10
140	-	0,25	-	0,06	398	0,7 x Di	10
150	-	0,25	-	0,06	427	0,7 x Di	10
160	-	0,20	-	0,06	527	0,7 x Di	10
180	-	0,20	-	0,06	590	0,7 x Di	10
200	-	0,20	-	0,05	660	0,7 x Di	10
250	-	0,10	-	0,04	825	0,7 x Di	10
300	-	0,06	-	0,03	990	0,7 x Di	10
350	-	0,05	-	0,02	1155	0,7 x Di	10
400	-	0,04	-	0,01	1320	0,7 x Di	10
450	-	0,03	-	0,01	1485	0,7 x Di	10

**ABRAZADERAS Y COLLARES DE APRIETE RECOMENDADOS**  
**RECOMMENDED CLAMP/COLLAR**

STF - Abrazaderas de tornillo Hose clamps with screw (pag. 204-207)  
STC - Abrazaderas con perno Hose clamps with bolt (pag. 208-210)



**COMPRESIBILIDAD AXIAL**  
AXIAL COMPRIMIBILITY:  
8:1

**-20°C / +90°C**  
con picos de hasta  
with peaks up to  
+100°C

**-4°F / +194°F**  
con picos de hasta  
with peaks up to  
+212°F

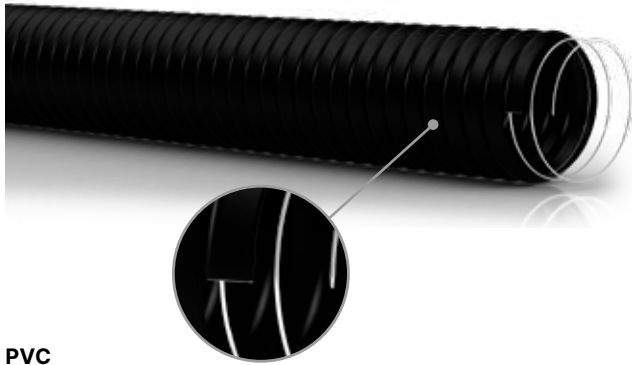

PVC



**USO  
APPLICATIONS**









Manguera flexible fabricada con lámina de elastómero termoplástico de 0,8 mm de espesor y espiral de alambre de acero incorporada. Adecuada para la aspiración de gases y humos incluso en presencia de disolventes y ácidos. Transporte neumático y aspiración de gránulos. Especialmente adecuada en presencia de humos corrosivos.

Indicated by aggressive fumes. Suction of gas and fumes plants, even with solvents and acids. Pneumatic conveyance, granule suction.



**ESTRUCTURA  
BODY**

<b>A</b>	<b>Material</b>	Manguera flexible fabricada con lámina de elastómero termoplástico de 0,8 mm de espesor. Flexible hose made of thermoplastic elastomer additivated with flame retardant and polyolefine (th. 0,80 mm).
<b>B</b>	<b>Refuerzos</b>	Espirales de alambre de acero armónico incorporada. Embedded steel wire helix.
<b>C</b>	<b>Capa exterior</b>	Corrugada. Corrugated.
	<b>Superficie</b>	Negro. Black.

 mm	 mm	 bar	 bar	 bar	 gr/mt	 mm	 m
40	-	0,50	-	0,25	228	28	10
50	-	0,40	-	0,20	295	35	10
60	-	0,40	-	0,16	342	42	10
70	-	0,35	-	0,14	399	49	10
80	-	0,28	-	0,10	456	56	10
100	-	0,20	-	0,09	515	70	10
120	-	0,20	-	0,08	610	80	10
130	-	0,20	-	0,08	684	90	10
150	-	0,10	-	0,06	772	105	10
160	-	0,10	-	0,06	850	110	10
180	-	0,09	-	0,05	935	128	10
200	-	0,08	-	0,05	1024	140	10
250	-	0,05	-	0,04	1280	175	10
300	-	0,03	-	0,03	1540	210	10
350	-	0,02	-	0,02	2340	245	10
400	-	0,02	-	0,02	2630	280	10
450	-	0,01	-	0,01	2960	315	10
500	-	0,01	-	0,01	3290	350	10



**ABRAZADERAS Y COLLARES DE APRIETE  
RECOMENDADOS  
RECOMMENDED CLAMP/COLLAR**

- STF - Abrazaderas de tornillo Hose clamps with screw (pag. 204-207)
- STC - Abrazaderas con perno Hose clamps with bolt (pag. 208-210)
- SSS - Abrazadera de salto espiral Spiral piepe clamp (pag. 219)



**NORMAS** NORMS:  
ISO 1307



**-20°C / +125°C**  
con picos de hasta  
with peaks up to  
+135°C  
**-4°F / +257°F**  
con picos de hasta  
with peaks up to  
+275°F

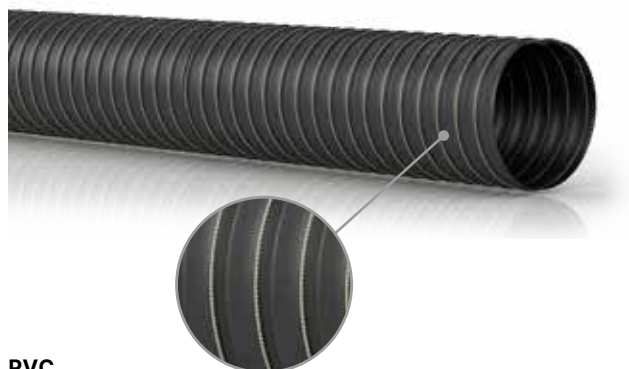

PVC



- **Excelente resistencia a bajas y altas temperaturas.**  
Excellent high and low temperature resistance.
- **Excelente flexibilidad.**  
Excellent flexibility.

**USO  
APPLICATIONS**

Adecuada para aspirar y conducir aire y humos calientes. Excelente resistencia a las altas y bajas temperaturas y a los disolventes.

For suction and delivery of air and hot fumes. Excellent high and low temperature resistance



**ESTRUCTURA  
BODY**

<b>A</b>	<b>Material</b>	Manguera fabricada con una capa de tejido en fibra de vidrio recubierta de neopreno. Flexible hose composed by a layer of glass-fiber fabric smeared of neoprene inside.
<b>B</b>	<b>Refuerzos</b> Reinforcement	Espiral de acero armónico cobrizo interior y visible, hilo exterior en fibra de vidrio. Visible spiral in coppered harmonic steel, external in glass-fiber.
<b>C</b>	<b>Capa exterior</b> Cover	Corrugada. Outside corrugated.
	<b>Superficie</b> Surface	Negro. Black.

mm	mm	bar	bar	bar	gr/mt	mm	m
19	-	1,7	-	-	80	6	4
25	-	1,6	-	-	120	8	4
38	-	1,3	-	-	168	12	4
51	-	1,2	-	-	250	16	4
63	-	1,1	-	-	300	20	4
76	-	1,1	-	-	410	25	4
89	-	1,0	-	-	490	29	4
95	-	0,9	-	-	550	33	4
102	-	0,9	-	-	650	35	4
114	-	0,9	-	-	720	40	4
127	-	0,8	-	-	800	46	4
152	-	0,7	-	-	980	50	4
178	-	0,6	-	-	1190	60	4
203	-	0,5	-	-	1330	68	4
254	-	0,4	-	-	1650	100	4
305	-	0,1	-	-	2000	116	4

**ABRAZADERAS Y COLLARES DE APRIETE  
RECOMENDADOS  
RECOMMENDED CLAMP/COLLAR**

STF - Abrazaderas de tornillo Hose clamps with screw (pag. 204-207)  
STC - Abrazaderas con perno Hose clamps with bolt (pag. 208-210)



**-55°C / +130°C**  
con picos de hasta  
with peaks up to  
+150°C

**-67°F / +266°F**  
con picos de hasta  
with peaks up to  
+302°F



# THERMOCORD

## NEOPRENE 150°C - 2S (2 CAPAS/LAYERS)

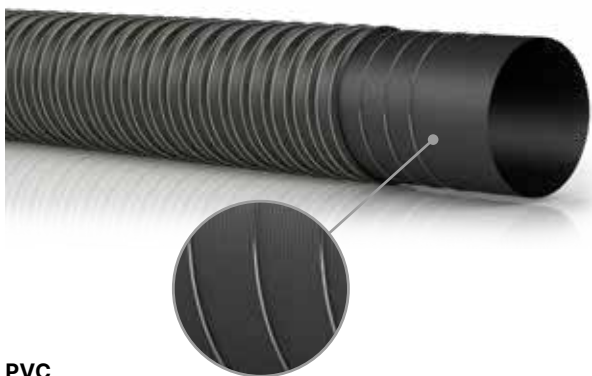

PVC



- **Excelente flexibilidad.**  
Excellent flexibility.



### USO APPLICATIONS

Aspiración y ventilación industrial. Refrigeración de equipos electrónicos y salas de máquinas de barcos. Aspiración de aire diésel, calefacción de automóviles.

Suitable for cooling of electronical machines and ship engine rooms. For diesel air suction and cars heating.



### ESTRUCTURA BODY

<b>A</b> Capa interior Tube	Manguera flexible fabricada con una doble capa de tejido en fibra de vidrio recubierto de neopreno. Flexible hose composed by two layers of neoprene coated fiberglass fabric.
<b>B</b> Refuerzos Reinforcement	Espiral incorporada en alambre de acero armónico cobreado, doble hilo exterior en fibra de vidrio. Embedded copper-plated steel wire helix and external double fiberglass cord.
<b>C</b> Capa exterior Cover	Corrugada. Outside corrugated.
Superficie Surface	Negro. Black.



### ABRAZADERAS Y COLLARES DE APRIETE RECOMENDADOS RECOMMENDED CLAMP/COLLAR

STF - Abrazaderas de tornillo Hose clamps with screw (pag. 204-207)  
STC - Abrazaderas con perno Hose clamps with bolt (pag. 208-210)



mm	mm	bar	bar	bar	gr/mt	mm	m
19	-	3	-	-	110	9	4
25	-	2,8	-	-	185	12	4
38	-	2,6	-	-	305	18	4
51	-	2,6	-	-	360	24	4
63	-	2,4	-	-	485	31	4
76	-	2,2	-	-	580	38	4
89	-	2,0	-	-	690	44	4
95	-	1,9	-	-	730	49	4
102	-	1,9	-	-	770	52	4
114	-	1,5	-	-	845	60	4
127	-	1,4	-	-	925	69	4
152	-	1,2	-	-	1200	75	4
178	-	1,0	-	-	1430	90	4
203	-	0,7	-	-	1650	101	4
254	-	0,5	-	-	2090	150	4
305	-	0,3	-	-	2550	200	4



**-55°C / +130°C**  
con picos de hasta  
with peaks up to  
+150°C

**-67°F / +266°F**  
con picos de hasta  
with peaks up to  
+302°F

# THERMOCORD

## SILICONE 300°C - 1S (1 CAPA/LAYER)

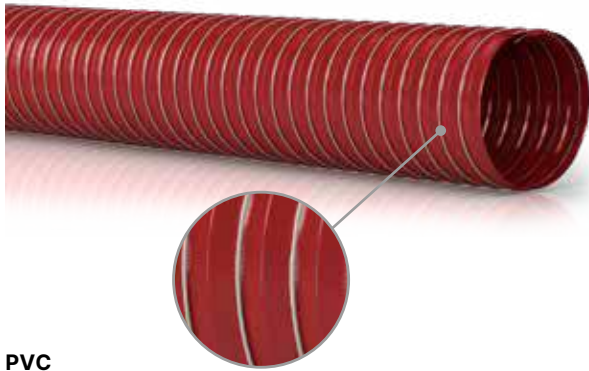

PVC



- **Excelente resistencia a las altas temperaturas.**  
Excellent high temperature resistance.
- **Excelente flexibilidad.**  
Excellent flexibility.



### USO APPLICATIONS

Adecuada para aspiración, extracción y conducción de aire con partículas polvorientas a altas temperaturas.

For suction, extraction and blowing air with dust particles also at high temperatures.



### ESTRUCTURA BODY

<b>A</b>	<b>Material</b>	Manguera flexible fabricada con una capa de tejido en fibra de vidrio recubierto de silicona. Flexible hose composed by a layer of glass-fiber fabric smeared of neoprene inside.
<b>B</b>	<b>Refuerzos</b> Reinforcement	Espiral de acero armónico cobrizo interior y visible, hilo exterior en fibra de vidrio. Visible spiral in coppered harmonic steel, external in glass-fiber.
<b>C</b>	<b>Capa exterior</b> Cover	Corrugada. Outside corrugated.
	<b>Superficie</b> Surface	Rojo ladrillo. Brick red.



### ABRAZADERAS Y COLLARES DE APRIETE RECOMENDADOS RECOMMENDED CLAMP/COLLAR

STF - Abrazaderas de tornillo Hose clamps with screw (pag. 204-207)  
STC - Abrazaderas con perno Hose clamps with bolt (pag. 208-210)



mm	mm	bar	bar	bar	gr/mt	mm	m
19	-	1,7	-	-	80	6	4
25	-	1,6	-	-	120	8	4
38	-	1,3	-	-	168	12	4
51	-	1,2	-	-	250	16	4
63	-	1,1	-	-	300	20	4
76	-	1,1	-	-	410	25	4
89	-	1,0	-	-	490	29	4
95	-	0,9	-	-	550	33	4
102	-	0,9	-	-	650	35	4
114	-	0,9	-	-	720	40	4
127	-	0,8	-	-	800	46	4
152	-	0,7	-	-	980	50	4
178	-	0,6	-	-	1190	60	4
203	-	0,5	-	-	1330	68	4
254	-	0,4	-	-	1650	100	4
305	-	0,1	-	-	2000	116	4



**COMPRESIBILIDAD AXIAL**  
AXIAL COMPRIMIBILITY:  
30%

**BAJO PEDIDO ES POSIBLE SUMINISTRAR:**  
VERSIÓN AUTOEXTINGUIBLE V-0 (UL 94),  
AZUL O GRIS.

AVAILABLE ON REQUEST: SELF-EXTINGUISHING  
VERSION V-0 (UL94), BLUE OR GREY.



**-60°C / +270°C**  
con picos de hasta  
with peaks up to  
+300°C

**-76°F / +518°F**  
con picos de hasta  
with peaks up to  
+572°F

# THERMOCORD

## SILICONE 300°C - 2S (2 CAPAS/LAYERS)

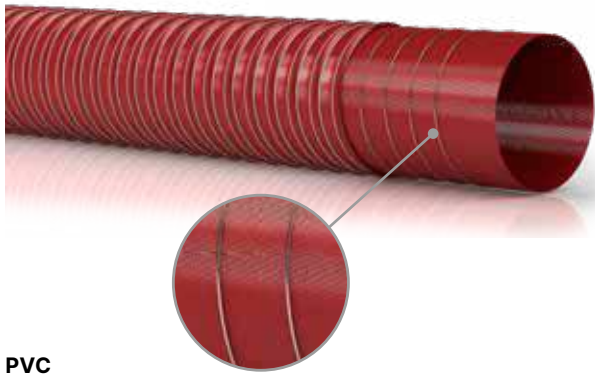

PVC



- **Excelente resistencia a las altas temperaturas.**  
Excellent high temperature resistance.
- **Excelente flexibilidad.**  
Excellent flexibility.



### USO APPLICATIONS

Aspiración, extracción y conducción de aire con partículas polvorientas a altas temperaturas.

For suction, extraction and blowing air with dust particles also at high temperatures.



### ESTRUCTURA BODY







<b>A</b> Capa interior Tube	Manguera flexible fabricada con una doble capa de tejido en fibra de vidrio recubierto de silicona. Flexible hose composed by two layers of silicone coated fiberglass fabric.
<b>B</b> Refuerzos Reinforcement	Espiral incorporada en alambre de acero armónico cobreado, doble hilo exterior en fibra de vidrio. Embedded copper-plated steel wire helix and external double fiberglass cord.
<b>C</b> Capa exterior Cover	Corrugada. Outside corrugated.
Superficie Surface	Rojo ladrillo. Brick red.



### ABRAZADERAS Y COLLARES DE APRIETE RECOMENDADOS RECOMMENDED CLAMP/COLLAR

STF - Abrazaderas de tornillo Hose clamps with screw (pag. 204-207)  
STC - Abrazaderas con perno Hose clamps with bolt (pag. 208-210)



 mm	 mm	 bar	 bar	 bar	 gr/mt	 mm	 m
19	-	3	-	-	110	9	4
25	-	2,8	-	-	185	12	4
38	-	2,6	-	-	305	18	4
51	-	2,6	-	-	360	24	4
63	-	2,4	-	-	485	31	4
76	-	2,2	-	-	580	38	4
89	-	2,0	-	-	690	44	4
95	-	1,9	-	-	730	49	4
102	-	1,9	-	-	770	52	4
114	-	1,5	-	-	845	60	4
127	-	1,4	-	-	925	69	4
152	-	1,2	-	-	1200	75	4
178	-	1,0	-	-	1430	90	4
203	-	0,7	-	-	1650	101	4
254	-	0,5	-	-	2090	150	4
305	-	0,3	-	-	2550	200	4



**COMPRESIBILIDAD AXIAL**  
AXIAL COMPRIMIBILITY:  
30%

**BAJO PEDIDO ES POSIBLE SUMINISTRAR:**  
VERSIÓN AUTOEXTINGUIBLE V-0 (UL 94),  
AZUL O GRIS.

AVAILABLE ON REQUEST: SELF-EXTINGUISHING  
VERSION V-0 (UL94), BLUE OR GREY.



**-60°C / +270°C**  
con picos de hasta  
with peaks up to  
+300°C

**-76°F / +518°F**  
con picos de hasta  
with peaks up to  
+572°F

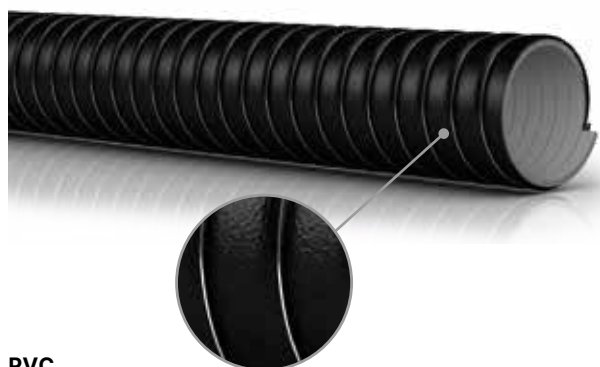

PVC

## USO APPLICATIONS

Se utiliza en aire acondicionado, ventilación mecánica de flujo simple y doble, reducción de condensados y pérdidas de calor, sistemas de aire acondicionado para aplicaciones de transporte, agricultura, industria y construcción naval.

Air conditioning, mechanical ventilation simple or double flow, reduction of condensation and heat dispersion, air conditioning plants for transport, agricultural, industrial and marine use.

## ESTRUCTURA BODY

<b>A</b> Material	Manguera flexible de película de resina de poliolefina aditivada, revestimiento termoaislante de espuma de polietileno reticulado de célula cerrada, protección exterior de película de resina de poliolefina aditivada. Addivated polyolefin resin film cover: flexible hose made of addivated polyolefin resins film, thermos, insulating coating in netted and closed cell foam polyethylene, external protection in addivated polyolefin resins film.
<b>B</b> Refuerzos Reinforcement	Espiral de alambre de acero armónico incorporada. Ambedded steel wire helix.
<b>C</b> Capa exterior Cover	Ligeramente corrugada. Slightly wavy.
<b>Superficie Surface</b>	Exterior negro, interior gris. Outside black, inside light grey.

## ESPUMA DE POLIETILENO RETICULADO TIPO CL1 NETTED POLYETHYLENE FOAM TYPE CL1

PROPIEDADES FÍSICO-MECÁNICAS Physical-mechanical properties	U.M. S.M.	MÉTODO Rules	VALORES Values
DENSIDAD Density	kg/m <sup>3</sup>	ISO 845	30
CLASE DE COMBUSTIÓN Class of combustion		CSF RF2/75° RF 3/77	CL 1
COEFICIENTE DE CONDUCTIVIDAD TÉRMICA A 0°C (λ) Coefficient of thermal conductivity at 0°C (λ)	W/mk kcal/min °C	UNI 7745 ASTM C177 UNI 7745 ASRM C177	0,0344 0,0294
COEFICIENTE DE CONDUCTIVIDAD TÉRMICA A 40°C (λ) Coefficient of thermal conductivity at 40°C (λ)	W/mk kcal/min °C	UNI 7745 ASTM C177 UNI 7745 ASRM C177	0,0372 0,0032
COEF. DE RESISTENCIA A LA DIFUSIÓN DEL VAPOR DE AGUA Coefficient of resistance to water steam diffusion	μ	DIN 52615	>65.000
PERMEABILIDAD AL VAPOR DE AGUA Permeability to water steam	Ng/Pa s m	DIN 52616	0,12
ABSORCIÓN DE AGUA DESPUÉS DE 24 días Water absorbtion after 24 days	Vol. %	DIN 53433	<3
RESISTENCIA A LA COMPRESIÓN AL 10% Compressive strenght at 10%	g/cm <sup>2</sup>	ISO 3386/1	190,00
ESTABILIDAD DIMENSIONAL Dimension stability	°C	DIN 53431	100
TEMPERATURA MÁX. DE USO Max operating temperature	°C	--	-80 +100
TEMPERATURA DE USO CON TENSIÓN MECÁNICA Operating temperature with mechanical stress	°C	--	-40 +100

mm	mm	bar	bar	bar	gr/mt	mm	m
50	-	0,70	-	0,18	96	35	10
60	-	0,70	-	0,15	115	42	10
70	-	0,60	-	0,13	128	49	10
80	-	0,50	-	0,09	154	56	10
102	-	0,40	-	0,08	200	70	10
127	-	0,40	-	0,07	254	92	10
152	-	0,20	-	0,05	308	105	10
160	-	0,15	-	0,05	331	110	10
180	-	0,15	-	0,05	438	130	10
203	-	0,15	-	0,04	492	140	10
254	-	0,08	-	0,03	600	175	10

**VELOCIDAD DEL AIRE AIR SPEED:**  
MAX 20 m/sec

**REACCIÓN AL FUEGO:**  
PELÍCULA INTERIOR Y EXTERIOR CLASE 1 - M1, PES  
ESPUMA CLASE 1 - M1  
**FIRE REACTION:**  
INTERNAL AND EXTERNAL FILM CLASS 1 - M1,  
PES CLOSED-CELL FOAM 1 - M1

**-40°C / +100°C**  
**-40°F / +212°F**



# MANGUERAS PARA MATERIALES ABRASIVOS

BULK MATERIAL HOSES





PVC



- **Apto para el contacto con productos alimenticios para los que los simulantes D2 y E según Reg. Europeo n.º 10/2011\*.**  
Suitable for the food contact in according with EU Regulation 10/2011 for D2 and E simulants\*.
- **Excelente resistencia a la abrasión.**  
Excellent resistance to abrasion.

**USO APPLICATIONS**

Adecuada para la aspiración de productos abrasivos: arena, grano, virutas y polvo en general. También es adecuada para el contacto con productos alimenticios secos, aceitosos y/o grasos para los que los simulantes D2 y E según Reg. Europeo n.º 10/2011\*. Especialmente indicada para talleres de carrocería, la industria maderera, cerámica y farmacéutica.

Suitable also for the fatty, oily or dry aliments in according with EU Regulation 10/2011 for D2 and E simulants. Particularly used for the car bodies and in the wood, ceramic and pharmaceutical industries.



**ESTRUCTURA BODY**

<b>A</b>	<b>Material</b>	Poliuretano. Polyurethane.
<b>B</b>	<b>Refuerzos Reinforcement</b>	Espiral de refuerzo en PVC antichoque. Shock resistant PVC spiral.
<b>C</b>	<b>Capa exterior Cover</b>	Corrugada. Outside corrugated.
	<b>Superficie Surface</b>	Marfil transparente. Transparent ivory.

mm	mm	PU mm	bar	bar	gr/mt	mm	m
20	25	0,35	-	0,5	100	20	20
25	30,4	0,35	-	0,5	150	25	20
30	36,0	0,35	-	0,5	190	30	20
32	38,0	0,35	-	0,5	200	32	20
35	41,4	0,35	-	0,4	215	35	20
38	44,6	0,40	-	0,4	230	38	20
40	46,6	0,40	-	0,4	250	40	20
45	51,8	0,45	-	0,4	280	45	20
50	57,0	0,50	-	0,4	310	50	20
60	67,4	0,50	-	0,4	390	60	20
63	70,6	0,50	-	0,4	430	63	20
70	78,4	0,55	-	0,4	500	70	20
75	83,8	0,55	-	0,4	550	75	20
80	89,0	0,55	-	0,4	610	80	20
90	99,4	0,55	-	0,4	715	90	20
100	110,4	0,60	-	0,4	820	100	20
110	120,4	0,60	-	0,3	890	110	20
120	131,0	0,60	-	0,3	950	120	20
125	136,6	0,65	-	0,3	1000	125	20
150	162,8	0,70	-	0,3	1365	150	20
160	173,0	0,70	-	0,3	1550	160	20
180	193,4	0,70	-	0,3	1900	180	20
200	213,6	0,80	-	0,3	2100	200	10

**ABRAZADERAS Y COLLARES DE APRIETE RECOMENDADOS**  
**RECOMMENDED CLAMP/COLLAR**

- STF - Abrazaderas de tornillo Hose clamps with screw (pag. 204-207)
- STC - Abrazaderas con perno Hose clamps with bolt (pag. 208-210)
- SSS - Abrazadera de salto espiral Spiral piepe clamp (pag. 219)



**NORMAS NORMS:**  
REG. UE 10/2011  
ISO 1307

**DECLARACIÓN DE CONFORMIDAD DISPONIBLE**  
DECLARATION OF COMPLIANCE IS AVAILABLE

**-25°C / +85°C**  
**-13°F / +185°F**

\* CONTACTO REPETIDO MÁXIMO DE 2 HORAS A TEMPERATURA MÁXIMA DE 70°C MAX 70°C FOR 2 HOURS

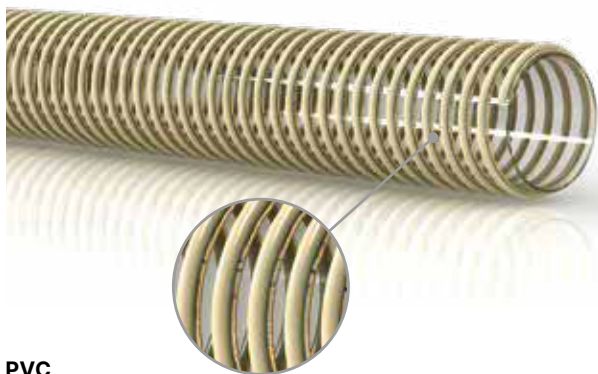

PVC



- **Apto para el contacto con productos alimenticios para los que los simulantes D2 y E según Reg. Europeo n.º 10/2011\*.**  
**Suitable for the food contact in according with EU Regulation 10/2011 for D2 and E simulants\*.**
- **Versión antiestática.**  
**Antistatic compound.**



**USO  
APPLICATIONS**

Versión antiestática. Adecuada para la aspiración de productos abrasivos: arena, grano, virutas y polvo en general. También es adecuada para el contacto con alimentos aceitosos y/o grasos, secos, para los que se proporcionan simulantes D2 y E de conformidad con el Reglamento europeo n.º 10/2011. Especialmente indicada para talleres de carrocería, la industria maderera, cerámica y farmacéutica.

Antistatic version. Suitable also for the fatty, oily or dry aliments in according with EU Regulation 10/2011 for D2 and E simulants. Particularly used for the car bodies and in the wood, ceramic and pharmaceutical industries.



**ESTRUCTURA  
BODY**









<b>A</b>	<b>Capa interior Tube</b>	Poliuretano. Polyurethane.
<b>B</b>	<b>Refuerzos Reinforcement</b>	Espiral de refuerzo en PVC antichoque. Shock resistant PVC spiral.
<b>C</b>	<b>Capa exterior Cover</b>	Corrugada. Outside corrugated.
	<b>Superficie Surface</b>	Marfil transparente. Transparent ivory.



**ABRAZADERAS Y COLLARES DE APRIETE  
RECOMENDADOS  
RECOMMENDED CLAMP/COLLAR**

- STF - Abrazaderas de tornillo Hose clamps with screw (pag. 204-207)
- STC - Abrazaderas con perno Hose clamps with bolt (pag. 208-210)
- SSS - Abrazadera de salto espiral Spiral piepe clamp (pag. 219)



 mm	 mm	 mm	 bar	 bar	 gr/mt	 mm	 m
20	25	0,35	-	0,5	100	20	20
25	30,4	0,35	-	0,5	150	25	20
30	36,0	0,35	-	0,5	190	30	20
32	38,0	0,35	-	0,5	200	32	20
35	41,4	0,35	-	0,4	215	35	20
38	44,6	0,40	-	0,4	230	38	20
40	46,6	0,40	-	0,4	250	40	20
45	51,8	0,45	-	0,4	280	45	20
50	57,0	0,50	-	0,4	310	50	20
60	67,4	0,50	-	0,4	390	60	20
63	70,6	0,50	-	0,4	430	63	20
70	78,4	0,55	-	0,4	500	70	20
75	83,8	0,55	-	0,4	550	75	20
80	89,0	0,55	-	0,4	610	80	20
90	99,4	0,55	-	0,4	715	90	20
100	110,4	0,60	-	0,4	820	100	20
110	120,4	0,60	-	0,3	890	110	20
120	131,0	0,60	-	0,3	950	120	20
125	136,6	0,65	-	0,3	1000	125	20
150	162,8	0,70	-	0,3	1365	150	20
160	173,0	0,70	-	0,3	1550	160	20
180	193,4	0,70	-	0,3	1900	180	20
200	213,6	0,80	-	0,3	2100	200	10



**NORMAS** NORMS:  
 REG. UE 10/2011 - ISO 1307  
 VERSIÓN QUÍMICAMENTE ANTIESTÁTICA  
 DISPONIBLE BAJO PEDIDO.  
 UPON REQUEST IT COULD BE PROVIDED WITH  
 ANTISTATIC COMPOUND.

**DECLARACIÓN DE CONFORMIDAD DISPONIBLE**  
 DECLARATION OF COMPLIANCE IS AVAILABLE



**-25°C / +85°C**  
**-13°F / +185°F**

\* CONTACTO REPETIDO MÁXIMO DE 2 HORAS A TEMPERATURA MÁXIMA DE 70°C MAX 70°C FOR 2 HOURS



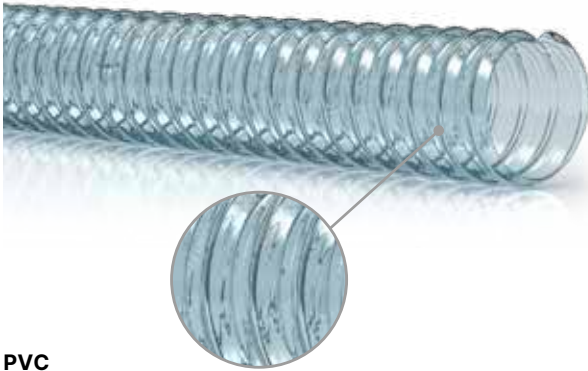

PVC

- 
**Excelente para las industrias maderera, cerámica y farmacéutica.**  
**Great for the wood, ceramic and pharmaceutical industries.**
- Excelente resistencia a la abrasión.**  
**Excellent resistance to abrasion.**

**USO APPLICATIONS**









Adecuada para la aspiración de polvos abrasivos en general. Especialmente indicada para talleres de carrocería, la industria maderera, cerámica y farmacéutica.

Suitable for suction of abrasive dust. Particularly used for the car bodies and in wood, ceramic and pharmaceutical industries.



**ESTRUCTURA BODY**

<b>A</b>	<b>Material</b>	Poliuretano. Polyurethane.
<b>B</b>	<b>Refuerzos</b> Reinforcement	Espiral de acero armónico galvanizado. Built-in steel spiral.
<b>C</b>	<b>Capa exterior</b> Cover	Corrugada. Outside corrugated.
	<b>Superficie</b> Surface	Transparente con espiral galvanizada. Transparent, galvanized steel spiral.

 mm	 mm	 bar	 bar	 bar	 gr/mt	 mm	 m
50	-	-	-	0,2	285	35	20
60	-	-	-	0,15	255	42	20
70	-	-	-	0,13	300	55	20
80	-	-	-	0,1	340	60	20
90	-	-	-	0,09	380	67	20
100	-	-	-	0,09	410	75	20
120	-	-	-	0,07	550	90	20
125	-	-	-	0,06	565	92	20
130	-	-	-	0,06	580	95	20
140	-	-	-	0,05	680	100	20
150	-	-	-	0,05	765	110	20
160	-	-	-	0,05	815	120	20
180	-	-	-	0,04	860	130	20
200	-	-	-	0,04	955	150	20
250	-	-	-	0,03	1150	180	10
300	-	-	-	0,02	1385	220	10
350	-	-	-	0,02	2030	250	10

**ABRAZADERAS Y COLLARES DE APRIETE RECOMENDADOS**  
**RECOMMENDED CLAMP/COLLAR**

- STF - Abrazaderas de tornillo Hose clamps with screw (pag. 204-207)
- STC - Abrazaderas con perno Hose clamps with bolt (pag. 208-210)
- SSS - Abrazadera de salto espiral Spiral piepe clamp (pag. 219)



**NORMAS** NORMS:  
ISO 1307

**COMPRESIBILIDAD AXIAL**  
AXIAL COMPRESSIBILITY:  
8:1

**-40°C / +90°C**  
**-40°F / +194°F**

\* CONTACTO REPETIDO MÁXIMO DE 2 HORAS A TEMPERATURA MÁXIMA DE 70°C MAX 70°C FOR 2 HOURS



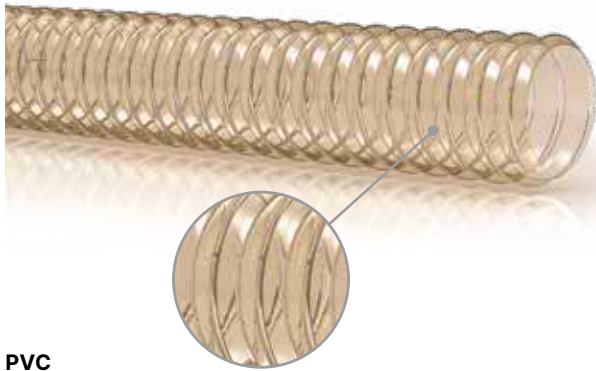

PVC



- **Apta para el contacto con productos alimenticios para los que están previstos los simulantes A, B, C, D2 y E\*.**  
**Suitable for the contact with food with the presence of A-B-C-D2 and E simulants.**



**USO  
APPLICATIONS**

Adecuada para la aspiración de polvos abrasivos en general. Adecuada para el contacto con alimentos acuosos, ácidos y alcohólicos (hasta el 20%), aceitosos y/o grasos y secos para los que se proporcionan los simulantes A, B, C, D2 y E\*. Especialmente indicada para talleres de carrocería, la industria maderera, cerámica y farmacéutica.

Suitable for suction of abrasive dust and for contact with food with a presence of oils and fats according to EU Regulation 10/2011 simulants A, B, C, D2 and E\*. Product recommended in panel beaters, wood industry, ceramic industry and in pharmaceutical industry.



**ESTRUCTURA  
BODY**

<b>A</b>	<b>Material</b>	Poliuretano. Polyurethane.
<b>B</b>	<b>Refuerzos</b> Reinforcement	Espiral de acero armónico cobreado. Built-in steel spiral.
<b>C</b>	<b>Capa exterior</b> Cover	Corrugada. Outside corrugated.
	<b>Superficie</b> Surface	Transparente con espiral cobreado. Transparent, copper plated steel spiral.



**ABRAZADERAS Y COLLARES DE APRIETE  
RECOMENDADOS  
RECOMMENDED CLAMP/COLLAR**

- STF - Abrazaderas de tornillo Hose clamps with screw (pag. 204-207)
- STC - Abrazaderas con perno Hose clamps with bolt (pag. 208-210)
- SSS - Abrazadera de salto espiral Spiral piepe clamp (pag. 219)



\* CONTACTO REPETIDO MÁXIMO DE 2 HORAS A TEMPERATURA MÁXIMA DE 70°C MAX 70°C FOR 2 HOURS

mm	mm	bar	bar	bar	gr/mt	mm	m
25	-	1	-	0,3	110	25	20
30	-	1	-	0,3	125	30	20
32	-	1	-	0,3	130	32	20
35	-	1	-	0,3	140	35	20
38	-	1	-	0,3	145	38	20
40	-	1	-	0,3	150	40	20
45	-	1	-	0,3	200	45	20
50	-	1	-	0,3	210	50	20
51	-	1	-	0,3	220	51	20
55	-	1	-	0,3	240	55	20
60	-	1	-	0,3	250	60	20
63	-	1	-	0,3	260	63	20
65	-	1	-	0,3	270	65	20
70	-	1	-	0,3	320	70	20
75	-	1	-	0,25	350	75	20
76	-	1	-	0,25	370	76	20
80	-	1	-	0,25	420	80	20
90	-	1	-	0,25	450	90	20
100	-	1	-	0,25	490	100	20
110	-	1	-	0,25	550	110	20
120	-	1	-	0,25	600	120	20
127	-	0,5	-	0,25	600	127	20
130	-	0,5	-	0,12	640	130	20
140	-	0,5	-	0,12	680	140	20
152	-	0,5	-	0,12	860	152	20
160	-	0,5	-	0,1	900	160	20
180	-	0,5	-	0,05	920	180	20
203	-	0,5	-	0,05	1020	203	20
254	-	0,5	-	0,03	1300	254	10
305	-	0,5	-	0,03	1500	305	10
355	-	0,5	-	0,02	1650	355	10



**NORMAS** NORMS:  
REG. UE 10/2011 - ISO 1307

**COMPRESIBILIDAD AXIAL**  
AXIAL COMPRESSIBILITY:  
8:1

**DECLARACIÓN DE CONFORMIDAD DISPONIBLE**  
DECLARATION OF COMPLIANCE IS AVAILABLE



**-40°C / +90°C**  
**-40°F / +194°F**

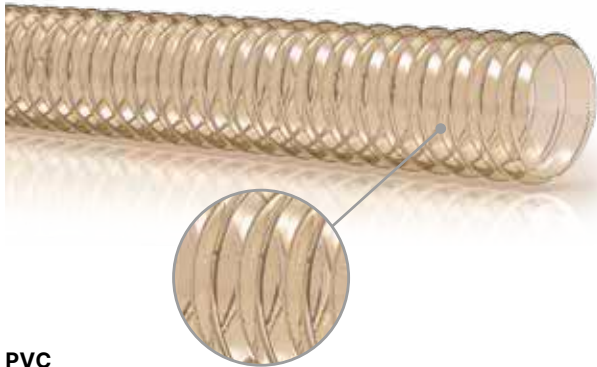

PVC



- **Apta para el contacto con productos alimenticios para los que están previstos los simulantes A, B, C D2 y E\*.**  
Suitable for the contact with food with the presence of A-B-C-D2 and E simulants.



**USO APPLICATIONS**

Adecuada para la aspiración de polvos abrasivos en general. Adecuada para el contacto con alimentos acuosos, ácidos y alcohólicos (hasta el 20%), aceitosos y/o grasos y secos para los que se proporcionan los simulantes A, B, C, D2 y E\*. Especialmente indicada para talleres de carrocería, la industria maderera, cerámica y farmacéutica.

Suitable for suction of abrasive dust and for contact with food with a presence of oils and fats according to EU Regulation 10/2011 simulants A, B, C, D2 and E\*. Product recommended in panel beaters, wood industry, ceramic industry and in pharmaceutical industry.



**ESTRUCTURA BODY**

<b>A</b>	<b>Material</b>	Poliuretano. Polyurethane.
<b>B</b>	<b>Refuerzos Reinforcement</b>	Espiral de acero armónico cobreado y pared reforzada. Galvanized steel copper spiral wire.
<b>C</b>	<b>Capa exterior Cover</b>	Corrugada. Outside corrugated.
	<b>Superficie Surface</b>	Transparente con espiral cobreado. Transparent, copper plated steel spiral.

mm	mm	bar	bar	bar	gr/mt	mm	m
25	-	1	-	0,3	180	25	20
30	-	1	-	0,3	200	30	20
32	-	1	-	0,3	240	32	20
38	-	1	-	0,3	250	38	20
40	-	1	-	0,3	270	40	20
45	-	1	-	0,3	280	45	20
50	-	1	-	0,3	330	50	20
60	-	1	-	0,3	440	60	20
63	-	1	-	0,3	460	63	20
70	-	1	-	0,25	490	70	20
75	-	1	-	0,25	530	75	20
80	-	1	-	0,25	500	80	20
90	-	1	-	0,25	680	90	20
100	-	1	-	0,25	700	100	20
110	-	1	-	0,25	720	110	20
120	-	1	-	0,25	1000	120	20
127	-	0,5	-	0,25	1100	127	20
130	-	0,5	-	0,12	1100	130	20
140	-	0,5	-	0,12	1150	140	20
152	-	0,5	-	0,12	1250	152	20
160	-	0,5	-	0,1	1280	160	20
180	-	0,5	-	0,05	1350	180	20
203	-	0,5	-	0,05	1500	203	20
254	-	0,5	-	0,03	2300	254	10
305	-	0,5	-	0,03	3200	305	10



**ABRAZADERAS Y COLLARES DE APRIETE RECOMENDADOS**  
**RECOMMENDED CLAMP/COLLAR**

- STF - Abrazaderas de tornillo Hose clamps with screw (pag. 204-207)
- STC - Abrazaderas con perno Hose clamps with bolt (pag. 208-210)
- SSS - Abrazadera de salto espiral Spiral piepe clamp (pag. 219)



\* CONTACTO REPETIDO MÁXIMO DE 2 HORAS A TEMPERATURA MÁXIMA DE 70°C MAX 70°C FOR 2 HOURS



**NORMAS NORMS:**  
ISO 1307  
**COMPRESIBILIDAD AXIAL**  
AXIAL COMPRIMIBILITY:  
8:1

**DECLARACIÓN DE CONFORMIDAD DISPONIBLE**  
DECLARATION OF COMPLIANCE IS AVAILABLE



**-40°C / +90°C**  
**-40°F / +194°F**

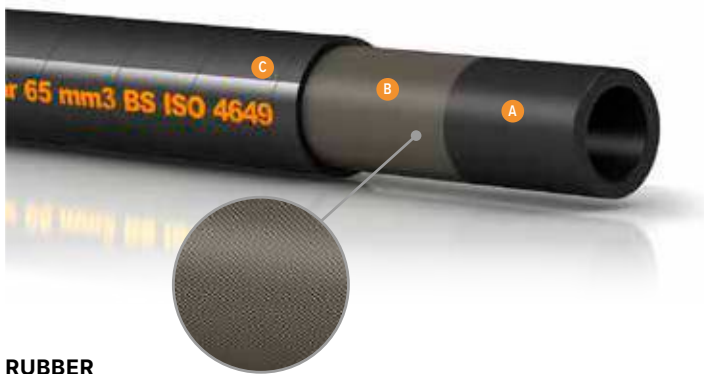

**RUBBER**



- **Ideal para chorro de arena.**  
Suitable for sandblast plants.



**USO  
APPLICATIONS**









Para entrega de arena de sílice, granalla metálica y materiales muy abrasivos o cortantes. Especialmente utilizada en chorro de arena.

For silica sand, blasting metal, stone and concrete surfaces. Particularly used for sandblast plants.



**ESTRUCTURA  
BODY**

<b>A</b>	<b>Capa interior Tube</b>	Caucho NR antiabrasivo antiestático de color negro. Abrasion resistant, antistatic natural rubber.
<b>B</b>	<b>Refuerzos Reinforcement</b>	Textiles sintéticos. High tensile synthetic textile.
<b>C</b>	<b>Capa exterior Cover</b>	Caucho NR de color negro antiestático resistente a la abrasión, a los agentes atmosféricos y al envejecimiento. Abrasion, ozone and weather resistant pin-pricked natural and synthetic antistatic rubber.
	<b>Superficie Surface</b>	Lisa con impresión de tela. Smooth with fabric impression.

 mm	 mm	 bar	 bar	 bar	 gr/mt	 mm	 m
10	21	12	36	-	321	110	40
13	21	12	36	-	256	117	40
13	25	12	36	-	434	127	40
16	30	12	36	-	583	160	40
19	34	12	36	-	696	190	40
25	40	12	36	-	837	254	40
30	45	12	36	-	987	300	40
32	48	12	36	-	1138	320	40
35	54	12	36	-	1507	350	40
40	60	12	36	-	1803	400	40
50	72	12	36	-	2347	508	40
60	82	12	36	-	2816	600	40
80	105	12	36	-	4247	800	40
90	115	12	36	-	4650	900	20-40
100	126	12	36	-	4650	1000	20-40



**NORMAS** NORMS:  
ISO 1307 - BS ISO 4649  
**MARCADOR** MARKING:  
EUROCORD® SABBIA HD WP 12 BAR 65 MM³ BS ISO 4649  
**EMBALAJE** BOX:  
EMBALAJE EN POLIETILENO NEGRO  
PACKAGING IN BLACK POLYETHYLENE



**-40°C / +70°C**  
**-40°F / +158°F**



**RUBBER**



- **Ideal para chorro de arena.**  
Suitable for sandblast plants.

**USO APPLICATIONS**

Para entrega de arena de sílice, granalla metálica y materiales muy abrasivos o cortantes. Especialmente utilizada en chorro de arena.

For silica sand, blasting metal, stone and concrete surfaces. Particularly used for sandblast plants.



**ESTRUCTURA BODY**

<b>A</b> Capa interior Tube	Caucho NR antiabrasivo antiestático de color negro. Abrasion resistant, antistatic natural rubber.
<b>B</b> Refuerzos Reinforcement	Textiles sintéticos. High tensile synthetic textile.
<b>C</b> Capa exterior Cover	Caucho NR de color negro antiestático resistente a la abrasión, a los agentes atmosféricos y al envejecimiento. Abrasion, ozone and weather resistant pin-pricked natural and synthetic antistatic rubber.
Superficie Surface	Lisa con impresión de tela. Smooth with fabric impression.

mm	mm	bar	bar	bar	gr/mt	mm	m
13	25	18	60	-	434	127	40
16	30	18	60	-	583	160	40
19	34	18	60	-	696	190	40
25	40	18	60	-	837	254	40
30	45	18	60	-	987	300	40
32	48	18	60	-	1138	320	40
35	54	18	60	-	1507	350	40
40	60	18	60	-	1803	400	40
50	70	18	60	-	2347	508	40
60	82	18	60	-	2816	600	40
80	105	18	60	-	4247	800	40

**NORMAS NORMS:**  
ISO 1307 - BS ISO 4649

**MARCADOR MARKING:**  
EUROCORD® SABBIA HD WP 18 BAR 65 MM³ BS ISO 4649

**EMBALAJE BOX:**  
EMBALAJE EN POLIETILENO NEGRO  
PACKAGING IN BLACK POLYETHYLENE

**-40°C / +70°C**  
**-40°F / +158°F**





**RUBBER**



**USO  
APPLICATIONS**

Adecuada para el transporte a baja presión de productos abrasivos y fluidos en general, en particular hormigón, yeso, escayola, grava y mortero.

Suitable for the low pressure transport of abrasive products and fluids in general. In particular for spraying plaster, grout, sand, sypsum, ready mixed concrete.



**ESTRUCTURA  
BODY**









<b>A</b> <b>Capa interior Tube</b>	Lisa en caucho negro antiabrasiva (NR/NBR). Abrasion resistant, antistatic natural rubber.
<b>B</b> <b>Refuerzos Reinforcement</b>	Textiles sintéticos de alta tenacidad. High tensile synthetic textile.
<b>C</b> <b>Capa exterior Cover</b>	Caucho negro antiabrasivo (NR/SBR) resistente a los agentes atmosféricos. Abrasion, ozone and weather resistant pin-pricked natural and synthetic rubber.
<b>Superficie Surface</b>	Lisa con impresión de tela. Smooth with fabric impression.



**ABRAZADERAS Y COLLARES DE APRIETE  
RECOMENDADOS  
RECOMMENDED CLAMP/COLLAR**

STC - Abrazaderas con perno Hose clamps with bolt (pag. 208-210)



 mm	 mm	 bar	 bar	 bar	 gr/mt	 mm	 m
51	68	12	36	-	1968	508	40
50	70	12	36	-	2271	508	40
50	74	12	36	-	2800	508	40
60	80	12	36	-	2659	600	40
60	82	12	36	-	2720	600	40
63	84	12	36	-	2790	630	40
65*	84	12	36	-	2820	650	40
65*	85	12	36	-	2841	650	40



**NORMAS NORMS:**  
ISO 1307  
**MARCADOR MARKING:**  
EUROCORD® ABRABETON W.P. 12 BAR

**EMBALAJE BOX:**  
EMBALAJE EN POLIETILENO TRANSPARENTE  
PACKAGING IN TRANSPARENT POLYETHYLENE



**-40°C / +70°C  
-40°F / +158°F**

\* VERSIONE 4 TELE 4 PLIES VERSION



**RUBBER**



**USO  
APPLICATIONS**

Adecuada para el transporte a baja presión de productos abrasivos y fluidos en general, en particular hormigón, yeso, escayola, grava y mortero.

Suitable for the low pressure transport of abrasive products and fluids in general. In particular for spraying plaster, grout, sand, sypsum, ready mixed concrete.



**ESTRUCTURA  
BODY**









<b>A</b> Capa interior Tube	Lisa en caucho negro antiabrasiva (NR/NBR). Abrasion resistant, antistatic natural rubber.
<b>B</b> Refuerzos Reinforcement	Textiles sintéticos de alta tenacidad. High tensile synthetic textile.
<b>C</b> Capa exterior Cover	Caucho negro antiabrasivo (NR/SBR) resistente a los agentes atmosféricos. Abrasion, ozone and weather resistant pin-pricked natural and synthetic rubber.
Superficie Surface	Lisa con impresión de tela. Smooth with fabric impression.



**ABRAZADERAS Y COLLARES DE APRIETE  
RECOMENDADOS  
RECOMMENDED CLAMP/COLLAR**

STC - Abrazaderas con perno Hose clamps with bolt (pag. 208-210)



 mm	 mm	 bar	 bar	 bar	 gr/mt	 mm	 m
20	31	40	120	-	360	200	40
25	37	40	120	-	683	254	40-61
30	42	40	120	-	930	300	40
30	45	40	120	-	1046	300	40
35	48	40	120	-	1136	350	40
40	55	40	120	-	1370	400	40
50	66	40	120	-	1746	508	40
50	68	40	120	-	1968	508	40
50	70	40	120	-	2271	508	40
50	74	40	120	-	2800	508	40



**NORMAS NORMS:**  
ISO 1307  
**MARCADOR MARKING:**  
EUROCORD® ABRABETON W.P. 40 BAR  
**EMBALAJE BOX:**  
EMBALAJE EN POLIETILENO TRANSPARENTE  
PACKAGING IN TRANSPARENT POLYETHYLENE



**-40°C / +70°C**  
**-40°F / +158°F**

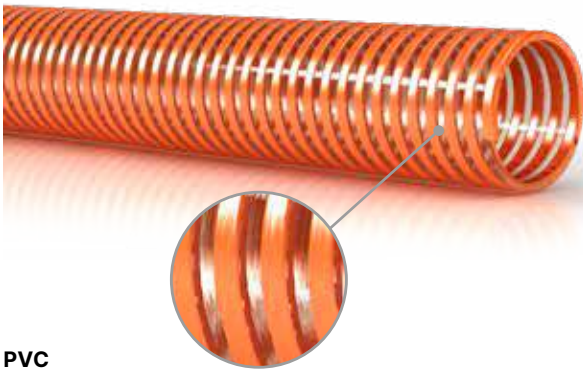

PVC



**USO**  
**APPLICATIONS**

Capa interior de poliuretano especialmente diseñado para la aspiración e impulsión de líquidos y lodos abrasivos. Especialmente indicado para acompañar silos o bombas de aspiración en obras y canteras.

For heavy-duty suction and delivery of water, slurries, dust and gravel, etc. In industrial and constructions.



**ESTRUCTURA**  
**BODY**

<b>A</b>	<b>Material</b>	PVC plastificado, resistente y flexible con capa interior de poliuretano antiabrasivo. Strong, flexible plasticized PVC with antiabrasive polyurethane inside layer.
<b>B</b>	<b>Refuerzos</b> <b>Reinforcement</b>	Espiral en PVC. Shock resistant PVC spiral.
<b>C</b>	<b>Capa exterior</b> <b>Cover</b>	Fabricado en PVC/PU, resistente a los impactos, los productos químicos, la abrasión y los agentes atmosféricos. Ligeramente corrugada. Crushing, chemical agents, abrasion and weather resistant, light corrugated outside.
	<b>Superficie</b> <b>Surface</b>	Lisa naranja transparente. Transparent.



**ABRAZADERAS Y COLLARES DE APRIETE**  
**RECOMENDADOS**  
**RECOMMENDED CLAMP/COLLAR**

STC - Abrazaderas con perno Hose clamps with bolt (pag. 208-210)  
BANDI BLOCK - Par de apriete Tightening torque (pag. 221)



- **Excelente resistencia a líquidos y lodos abrasivos.**  
**Excellent resistance in abrasive applications.**



mm	mm	bar	bar	bar	gr/mt	mm	m
25	32,8	-	6,5	0,8	270	100	25
30	37,6	-	6,0	0,8	360	120	25
32	40,7	-	6,0	0,8	380	128	25
35	44,1	-	5,5	0,8	400	140	25
38	47,1	-	5,0	0,8	430	152	25
40	49,5	-	5,0	0,8	480	160	25
45	55,5	-	5,0	0,8	550	180	25
50	60,5	-	4,5	0,8	600	200	25
60	71,3	-	4,0	0,8	800	240	20
63	74,3	-	4,0	0,8	850	252	20
70	80,0	-	4,0	0,8	1000	280	20
76	88,5	-	4,0	0,8	1100	304	20
80	93,5	-	4,0	0,8	1260	320	20
90	103,7	-	3,0	0,8	1400	360	20
100	114,9	-	3,0	0,8	1600	400	20
120	135,3	-	2,0	0,7	2500	480	20
127	144,7	-	2,0	0,7	2700	508	20
150	168,1	-	1,0	0,6	3400	600	20



**NORMAS** **NORMS:**  
ISO 1307



**-5°C / +60°C**  
**+23°F / +140°F**

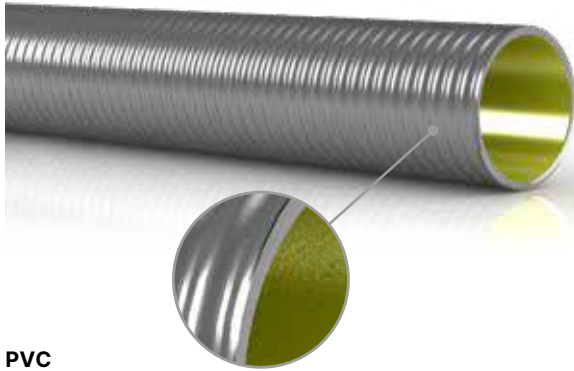

PVC



- **Estructura reforzada de alta resistencia.**  
Reinforced structure for heavy uses.



**USO**  
**APPLICATIONS**

Especialmente diseñada para el paso de material muy abrasivo, especialmente indicado como pieza final de una manguera para hormigón. Excelente resistencia a las fluctuaciones de temperatura.

For heavy-duty suction and delivery of water, slurries, dust and gravel, etc. in industrial and constructions. Excellent resistance in abrasive applications.



**ESTRUCTURA**  
**BODY**

<b>A</b>	<b>Material</b>	PVC flexible con capa interior de poliuretano PU. Strong, flexible plasticized PVC with antiabrasive polyurethane inside layer.
<b>B</b>	<b>Refuerzos</b> Reinforcement	Espiral en PVC antichoque. Shock resistant PVC spiral.
<b>C</b>	<b>Capa exterior</b> Cover	En PVC resistente a la abrasión, los agentes atmosféricos y el ozono. Crushing, chemical agents, abrasion and weather resistant, light corrugated outside.
	<b>Superficie</b> Surface	Gris metálico ligeramente corrugado, interior amarillo. Metallic grey, inner yellow.

mm	mm	bar	bar	bar	gr/mt	mm	m
25	4,2	20	-	0,9	500	162	50
32	4,6	17	-	0,9	600	208	50
38	5,0	16	-	0,9	700	247	50
40	5,0	16	-	0,9	770	275	50
45	5,0	15	-	0,9	950	300	50
50	5,2	15	-	0,9	1050	330	50
55	5,3	15	-	0,9	1200	357	50
60	5,3	15	-	0,9	1300	400	50
63	5,6	14	-	0,9	1400	409	50
65	5,7	14	-	0,9	1450	422	50
70	5,7	13	-	0,9	1550	455	50
75	6,0	13	-	0,9	1750	495	50
80	6,2	13	-	0,9	1950	540	50
90	6,2	12	-	0,9	2150	585	25
100	6,3	12	-	0,9	2700	700	25
110	6,9	11	-	0,9	3000	770	25
120	7,3	10	-	0,9	3300	880	25
125	7,8	10	-	0,9	3600	970	25
150	8,8	10	-	0,8	5200	1210	25
160	9,2	9	-	0,7	5650	1280	25
200	10,5	8	-	0,7	8000	1600	25



**ABRAZADERAS Y COLLARES DE APRIETE**  
**RECOMENDADOS**  
**RECOMMENDED CLAMP/COLLAR**

STC - Abrazaderas con perno Hose clamps with bolt (pag. 208-210)



**NORMAS** NORMS:  
ISO 1307



**-5°C / +60°C**  
**+23°F / +140°F**





**RUBBER**



- Buena resistencia e ideal para productos abrasivos de pequeña granulometría.  
Great resistance and particularly used for small abrasive products.



**USO APPLICATIONS**





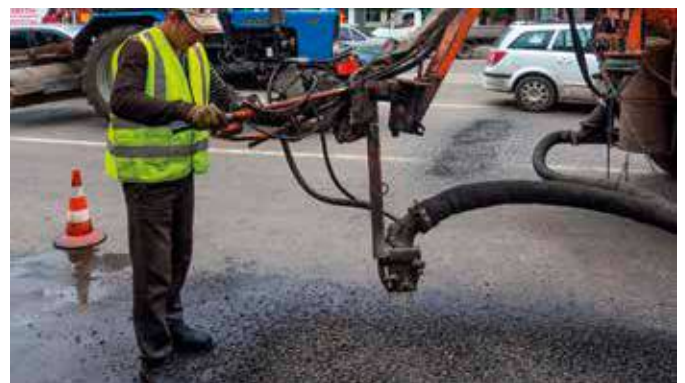



Para entrega a presión de cemento en polvo, arena húmeda, morteros líquidos, piedra caliza en polvo y, en general, productos abrasivos de grano pequeño. Se utiliza para la carga y descarga por gravitación o para sistema neumático de silos de almacenamiento y cisternas.

For discharge of dry bulk materials, sand, gravel, dry cement, etc. Particularly used for the loading and unloading of silos and tankers.



**ESTRUCTURA BODY**

<b>A</b> Capa interior Tube	Lisa en caucho negro antiabrasiva conductiva R< 5×10 Ω/m. Abrasion resistant, antistatic natural rubber R< 5×10 Ω/m.
<b>B</b> Refuerzos Reinforcement	Refuerzos de fibra sintética de alta resistencia. High tensile synthetic textile and antistatic copper wire.
<b>C</b> Capa exterior Cover	Caucho negro antiestático, resistente a la abrasión y a los agentes atmosféricos. Abrasion, ozone and weather resistant pin-pricked natural and synthetic rubber.
<b>Superficie Surface</b>	Lisa con impresión de tela. Smooth with fabric impression.

 mm	 mm	 bar	 bar	 bar	 gr/mt	 mm	 m
102	110	10	30	-	1783	-	20
102	118	10	30	-	3288	-	20



**ABRAZADERAS Y COLLARES DE APRIETE RECOMENDADOS**  
**RECOMMENDED CLAMP/COLLAR**

STC - Abrazaderas con perno Hose clamps with bolt (pag. 208-210)



**NORMAS NORMS:**  
ISO 1307  
**MARCADOR MARKING:**  
EUROCORD® CEMENTO HD W.P. 10 BAR  
**EMBALAJE BOX:**  
EMBALAJE EN POLIETILENO TRANSPARENTE  
PACKAGING IN TRANSPARENT POLYETHYLENE



**-40°C / +70°C**  
**-40°F / +158°F**



**RUBBER**



- Buena resistencia e ideal para productos abrasivos de pequeña granulometría.  
Great resistance and particularly used for small abrasive products.

**USO APPLICATIONS**

Para la aspiración y entrega a presión de cemento en polvo, arena húmeda, mortero líquido, piedra caliza en polvo y, en general, productos abrasivos de grano pequeño. Se utiliza para la carga y descarga por gravitación o para sistema neumático de silos de almacenamiento y cisternas.

For discharge of dry bulk materials, sand, gravel, dry cement, etc. Particularly used for the loading and unloading of silos and tankers.

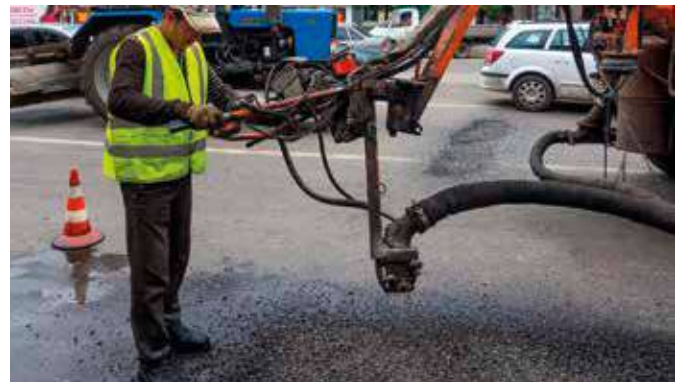

**ESTRUCTURA BODY**

<b>A</b> Capa interior Tube	Lisa en caucho negro antiabrasiva conductiva R< 5×10 Ω/m. Abrasion resistant, antistatic natural rubber R< 5×10 Ω/m.
<b>B</b> Refuerzos Reinforcement	Refuerzos de fibras sintéticas de alta resistencia y espiral metálica insertada. High tensile synthetic textile, steel wire helix and antistatic copper wire.
<b>C</b> Capa exterior Cover	Caucho negro antiestático, resistente a la abrasión y a los agentes atmosféricos. Abrasion, ozone and weather resistant pin-pricked natural and synthetic rubber.
Superficie Surface	Lisa con impresión de tela. Smooth with fabric impression.

mm	mm	bar	bar	bar	gr/mt	mm	m
25	40	10	30	0,8	907	155	40
32	45	10	30	0,8	1076	190	40
38	52	10	30	0,8	1434	230	40
50	66	10	30	0,8	2008	305	40
63	78	10	30	0,8	2442	380	40
76	92	10	30	0,8	3128	460	40
90	107	10	30	0,8	3815	540	40
100	120	10	30	0,8	4608	610	40

**ABRAZADERAS Y COLLARES DE APRIETE RECOMENDADOS**  
**RECOMMENDED CLAMP/COLLAR**

STC - Abrazaderas con perno Hose clamps with bolt (pag. 208-210)



**NORMAS** NORMS:  
ISO 1307  
**MARCADOR** MARKING:  
EUROCORD® CEMENTO SP W.P. 10 BAR  
**EMBALAJE** BOX:  
EMBALAJE EN POLIETILENO TRANSPARENTE  
PACKAGING IN TRANSPARENT POLYETHYLENE



**-40°C / +70°C**  
**-40°F / +158°F**

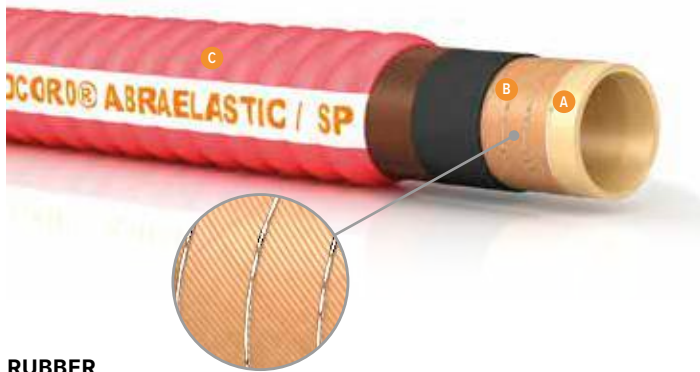

**RUBBER**



- Buena resistencia e ideal para productos abrasivos de pequeña granulometría. Excellent flexibility and lightness.



**USO APPLICATIONS**

Manguera diseñada para el paso de materiales abrasivos. Buena resistencia a todos los materiales muy abrasivos como granalla metálica, cemento, cereales, gránulos de plástico, polvos abrasivos. Buena resistencia a la flexión y a la tensión. Excelente resistencia a los agentes atmosféricos. Manguera muy ligera y extremadamente flexible, su estructura especial permite pequeños radios de curvatura. Gran elasticidad y, sobre todo, gracias a la capa interior en caucho natural, gran resistencia a la abrasión.

Great resistance to banding stress, great resistance to atmospheric agents. Very light and flexible hose, its structure permits low banding radiuses. Excellent flexibility thanks to its natural rubber inner layer.



**ESTRUCTURA BODY**

<b>A</b> Capa interior Tube	Caucho natural (NR) de color avellana claro. Abrasion resistant natural rubber (beige colour).
<b>B</b> Refuerzos Reinforcement	Textiles de alta tenacidad y espiral metálica incorporada. High tensile synthetic textile, steel wire helix.
<b>C</b> Capa exterior Cover	Corrugado en caucho para natural (NR) de color rojo. Abrasion, ozone and weather resistant corrugated special sythetic rubber.
<b>Superficie Surface</b>	Corrugada, de color rojo, de impresión en tela. Corrugated, red color, with fabric impression.



**ABRAZADERAS Y COLLARES DE APRIETE RECOMENDADOS RECOMMENDED CLAMP/COLLAR**

STC - Abrazaderas con perno Hose clamps with bolt (pag. 208-210)



mm	mm	bar	bar	bar	gr/mt	mm	m
50	63	7	21	0,8	1218	180	40
70	80	5	15	0,8	1750	290	40
76	86	5	15	0,8	1820	310	40
101	114	3	9	0,8	3091	450	40
115	128	3	9	0,8	4060	520	40
120	133	3	9	0,8	4193	510	40
152	167	3	9	0,8	5976	670	40



**NORMAS NORMS:**  
ISO 1307  
**MARCADOR MARKING:**  
EUROCORD® ABRAELASTIC SP  
**EMBALAJE BOX:**  
EMBALAJE EN POLIETILENO NEGRO  
PACKAGING IN BLACK POLYETHYLENE



**-40°C / +70°C**  
**-40°F / +158°F**



**RUBBER**



- **Generalmente se suministran con racores victaulic.**  
Generally supplied with victaulic fittings.

**USO APPLICATIONS**

Adecuada para el bombeo a alta presión de hormigón en puntos de vertido. Por lo general, se suministra ya cortado a la medida necesaria y con racores victaulic.

For high pressure concrete pumping and placing used in the end of boom of concrete pump. Generally supplied already cutted and with victaulic fittings.



**ESTRUCTURA BODY**

<b>A</b> <b>Capa interior</b> Tube	Liso en caucho especial natural SBR conductiva y resistente a la abrasión. Abrasion resistant antistatic natural and SBR rubber.
<b>B</b> <b>Refuerzos</b> Reinforcement	Hilo de acero de alta tenacidad. High tensile steel cords.
<b>C</b> <b>Capa exterior</b> Cover	Caucho sintético especial microperforado resistente a los agentes atmosféricos, a la abrasión y el ozono. Abrasion, ozone and weather resistant pin-pricked special synthetic rubber.
<b>Superficie</b> Surface	Lisa con impresión de tela. Smooth with fabric impression.

mm	mm	bar	bar	bar	gr/mt	mm	m
50,8	70	85	200	-	3410	508	20
63,5	88	85	200	-	4970	635	20
76,2	102	85	200	-	6581	762	20
101,6	126	85	200	-	9376	1016	20
127	155	85	200	-	10951	1270	20
152,4	184	85	175	-	13494	1524	20

**NORMAS** NORMS:  
ISO 1307

**MARCADOR** MARKING:  
EUROCORD® ABRABETON PUMP WP 85 BAR

**EMBALAJE** BOX:  
EMBALAJE EN POLIETILENO TRANSPARENTE  
PACKAGING IN TRANSPARENT POLYETHYLENE

**-40°C / +70°C**  
**-40°F / +158°F**



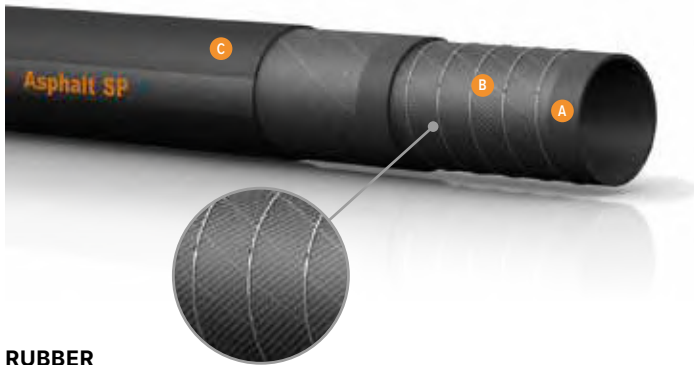

**RUBBER**



- Para cargar y descargar betún caliente hasta 180 °C.  
For suction and discharge of hot asphalt up to 180°C.



**USO APPLICATIONS**

Para cargar y descargar betún caliente hasta 180° en camiones, camiones cisterna, construcción de carreteras, etc.

For suction and discharge of tar and hot asphalt on tank trucks & tank cars, etc. in road constructions up to 180°C.

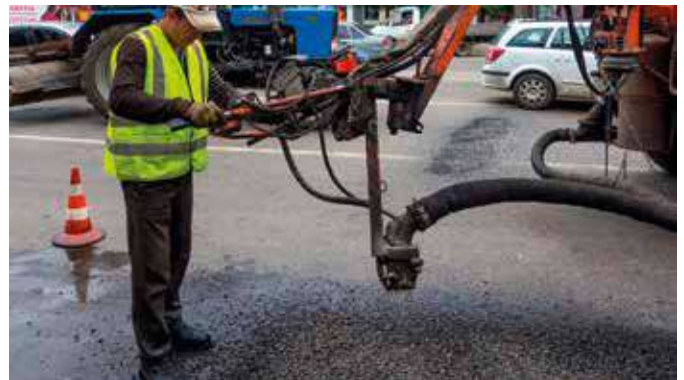

**ESTRUCTURA BODY**









<b>A</b>	<b>Capa interior Tube</b>	Caucho acrílico sintético especial resistente al calor. Heat resistant, special synthetic acrylic rubber.
<b>B</b>	<b>Refuerzos Reinforcement</b>	Refuerzos textiles de alta tenacidad con doble espiral de acero e hilo de cobre antiestático. High tensile synthetic textile, 2 steel wire helix and antistatic copper wire.
<b>C</b>	<b>Capa exterior Cover</b>	Caucho sintético especial con excelente resistencia al betún caliente, la abrasión, los aceites y la intemperie. Abrasion, heat, weather, oil and asphalt resistant special synthetic rubber.
	<b>Superficie Surface</b>	Lisa con impresión de tela. Smooth with fabric impression.



**ABRAZADERAS Y COLLARES DE APRIETE RECOMENDADOS**  
**RECOMMENDED CLAMP/COLLAR**

STC - Abrazaderas con perno Hose clamps with bolt (pag. 208-210)



 mm	 mm	 bar	 bar	 bar	 gr/mt	 mm	 m
25,4	43	18	54	-0,92	1238	115	40-46-61
32	50	18	54	-0,92	1496	150	40-46-61
38	56	18	54	-0,92	1830	180	40-46-61
44,5	64	18	54	-0,92	2344	220	40-46-61
50,8	71	18	54	-0,92	2776	250	40-46-61
63,5	83	10	30	-0,92	3129	320	40-46-61
70	91	10	30	-0,92	3807	360	40-46-61
76,2	97	10	30	-0,92	4107	400	40-46-61
101,6	126	10	30	-0,92	6168	520	40-46-61
127	153	10	30	-0,92	8152	680	40-46-61
152,4	179	10	30	-0,92	10229	850	40-46-61



**NORMAS** NORMS:  
ISO 1307  
**MARCADOR** MARKING:  
EUROCORD® ASPHALT SP  
**EMBALAJE** BOX:  
EMBALAJE EN POLIETILENO NEGRO  
PACKAGING IN BLACK POLYETHYLENE



**-40°C / +180°C**  
**-40°F / +356°F**



**RUBBER**



- **Goma especial resistente a la abrasión.**  
Special abrasive resistant rubber.

**USO APPLICATIONS**









Comúnmente utilizada en las máquinas de limpieza viaria. La manguera se fabrica enfundada con manguitos.

Used on street cleaning machines. Extremely flexible. The hose is produced with cuffs-ends.



**ESTRUCTURA BODY**

<b>A</b> Capa interior Tube	Caucho sintético especial, resistente a la abrasión. Abrasion resistant special syntethic rubber.
<b>B</b> Refuerzos Reinforcement	Refuerzos textiles. Special synthetic textile.
<b>C</b> Capa exterior Cover	Caucho sintético especial, resistente a la abrasión. Abrasion resistant special syntethic rubber.
Superficie Surface	Corrugada. Corrugated.

 mm	 mm	 bar	 bar	 bar	 gr/mt	 mm	 m
152	162	-	-	-	3450	150	A petición On request
203	215	-	-	-	4300	200	A petición On request
254	270	-	-	-	5900	250	A petición On request

SE PUEDEN FABRICAR OTROS DIÁMETROS Y LONGITUDES POR ENCARGO / OTHER MEASURES ON REQUEST

**ABRAZADERAS Y COLLARES DE APRIETE RECOMENDADOS**  
RECOMMENDED CLAMP/COLLAR

STC - Abrazaderas con perno Hose clamps with bolt (pag. 208-210)



**NORMAS** NORMS:  
ISO 1307  
**MARCADOR** MARKING:  
EUROCORD® STREET SWEEPER  
POSIBILIDAD DE PERSONALIZAR EL TAMAÑO DEL MANGUITO  
CUSTOMIZABLE CUFF-ENDS LENGHTS



**-25°C / +70°C**  
**-13°F / +158°F**

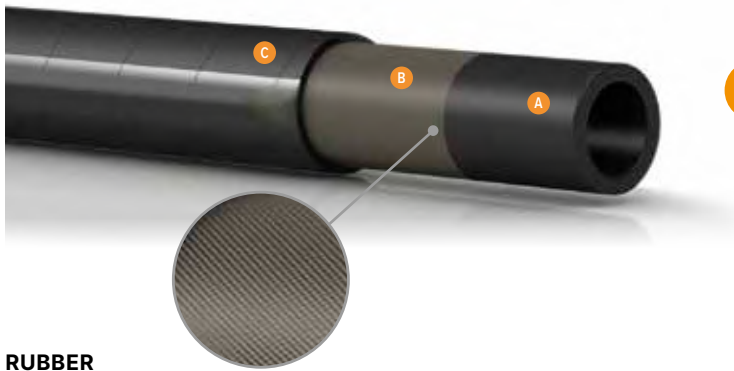

**RUBBER**



- **Adecuada para productos abrasivos.**  
Suitable for abrasive products.



**USO  
APPLICATIONS**

Para la aspiración y entrega de productos abrasivos secos, diseñado para sistemas de aspiración, gravitación y neumáticos.

Suitable for abrasive products. Suitable for plants that work in suction, gravity and pneumatic systems.



**ESTRUCTURA  
BODY**

**A**  
**Capa interior Tube**

Liso en caucho antiabrasivo NR negro (50 mm<sup>3</sup> DIN 53516), antiestático (R<106 Ω/m).  
Blend of synthetic and natural elastometer, black smooth, high abrasion resistant (50 mm<sup>3</sup> DIN 53516), antistatic (R<106 Ω/m).

**B**  
**Refuerzos  
Reinforcement**

Textiles sintéticos de alta tenacidad.  
High textile syntetic fabric.

**C**  
**Capa exterior Cover**

Caucho negro antiabrasivo (NR/SBR), antiestático, resistente a los agentes atmosféricos. Blend of synthetic and natural elastometer, black, smooth with cloth impression, antistatic, abrasion, weather and ozone restistant.

**Superficie Surface**

Lisa con impresión de tela.  
Smooth with fabric impression.



**ABRAZADERAS Y COLLARES DE APRIETE  
RECOMENDADOS  
RECOMMENDED CLAMP/COLLAR**

STC - Abrazaderas con perno Hose clamps with bolt (pag. 208-210)



mm	mm	bar	bar	bar	gr/mt	mm	m
75	93	9	6	18	550	2,95	40
100	132	11	6	18	810	5,47	40



**NORMAS** NORMS:  
ISO 1307 - DIN 53516

**MARCADOR** MARKING:  
EUROCORD® SILO HD

**EMBALAJE** BOX:  
EMBALAJE EN POLIETILENO TRANSPARENTE  
PACKAGING IN TRANSPARENT POLYETHYLENE



**-30°C / +85°C**  
**-22°F / +185°F**

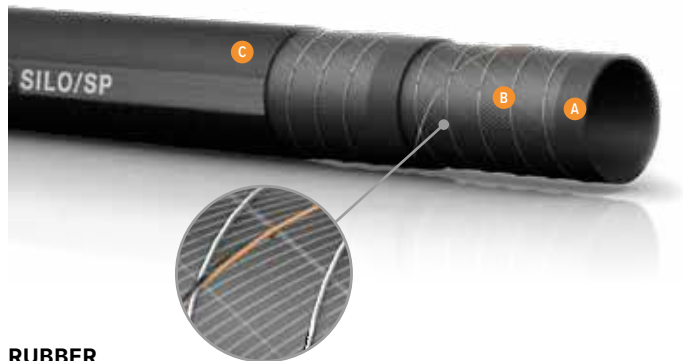

**RUBBER**

**USO APPLICATIONS**

Para la aspiración y entrega de productos abrasivos secos, diseñado para sistemas de aspiración, gravitación y neumáticos.

Suitable for abrasive products. Suitable for plants that work in suction, gravity and pneumatic systems.

**ESTRUCTURA BODY**

<b>A</b> Capa interior Tube	Liso en caucho antiabrasivo NR negro (50 mm <sup>3</sup> DIN 53516), antiestático (R<106 Ω/m). Blend of synthetic and natural elastometer, black smooth, high abrasion resistant (50 mm <sup>3</sup> DIN 53516), antistatic (R<106 Ω/m).
<b>B</b> Refuerzos Reinforcement	Textiles sintéticos de alta tenacidad, espiral de acero, cable de cobre. Textile cord, steel helix, antistatic wire, rubber layer.
<b>C</b> Capa exterior Cover	Caucho negro antiabrasivo (NR/SBR), antiestático, resistente a los agentes atmosféricos. Blend of synthetic and natural elastometer, black, smooth with cloth impression, antistatic, abrasion, weather and ozone resistant.
Superficie Surface	Lisa con impresión de tela. Smooth with fabric impression.

**ABRAZADERAS Y COLLARES DE APRIETE RECOMENDADOS RECOMMENDED CLAMP/COLLAR**

STC - Abrazaderas con perno Hose clamps with bolt (pag. 208-210)



- **Adecuada para productos abrasivos. Suitable for abrasive products.**



mm	mm	bar	bar	bar	gr/mt	mm	m
75	93	9	6	18	550	2,95	40
100	132	11	6	18	810	5,47	40

**NORMAS** NORMS:  
ISO 1307 - DIN 53516

**MARCADOR** MARKING:  
EUROCORD® SILO SP

**EMBALAJE** BOX:  
EMBALAJE EN POLIETILENO TRANSPARENTE  
PACKAGING IN TRANSPARENT POLYETHYLENE

**-30°C / +85°C**  
**-22°F / +185°F**





**RUBBER**



- **Radio de curvatura excepcionalmente estrechos.**  
Exceptionally tight banding radiuses.



**USO APPLICATIONS**









Para la aspiración industrial de aire y humos. Especialmente adecuada cuando se requieren radios de curvatura pequeños, ligereza y flexibilidad. Tiene una amplia aplicación en los sistemas de aspiración industrial.

Particularly used where small banding radius, flexibility and lightness are requested. It can be used on industrial suction plants.



**ESTRUCTURA BODY**

<b>A</b>	<b>Capa interior Tube</b>	Liso en caucho EPDM negro. Natural and synthetic rubber.
<b>B</b>	<b>Refuerzos Reinforcement</b>	Textiles sintéticos de alta tenacidad y espiral metálica incorporada. Synthetic textile and steel helix wire.
<b>C</b>	<b>Capa exterior Cover</b>	Caucho negro EPDM resistente a los agentes atmosféricos, al ozono y a la abrasión. Abrasion, ozone, weather and heat resistant synthetic rubbercorrugated.
	<b>Superficie Surface</b>	Corrugada en impresión en tela. Corrugated with fabric impression.

 mm	 mm	 bar	 bar	 bar	 gr/mt	 mm	 m
30	3,5	-	-	0,6	-	120	40
32	3,5	-	-	0,6	-	130	40
35	3,5	-	-	0,6	-	140	40
38	3,5	-	-	0,6	-	150	40
40	3,5	-	-	0,6	-	160	40
45	3,5	-	-	0,6	-	180	40
50	3,5	-	-	0,6	-	200	40
60	3,5	-	-	0,6	-	240	40
70	3,5	-	-	0,6	-	280	40
75	3,5	-	-	0,6	-	300	40
80	3,5	-	-	0,6	-	320	40
90	3,5	-	-	0,6	-	360	40
102	3,5	-	-	0,6	-	400	40



**ABRAZADERAS Y COLLARES DE APRIETE RECOMENDADOS**  
**RECOMMENDED CLAMP/COLLAR**

STC - Abrazaderas con perno Hose clamps with bolt (pag. 208-210)



**NORMAS** NORMS:  
ISO 1307  
**MARCADOR** MARKING:  
EUROCORD® SILO HD  
**EMBALAJE** BOX:  
EMBALAJE EN POLIETILENO NEGRO  
PACKAGING IN BLACK POLYETHYLENE



**-20°C / +70°C**  
**- 4°F / +158°F**



- **Excelente elongación.**  
Great elongation.

### RUBBER



#### USO APPLICATIONS

Manguito en caucho utilizado para transportar material a granel a la salida de la tolva (arena, cemento, grava, cereales).

Discharge of abrasive materials, such as sand, gravel, cement, grain and powder without pressure.



#### ESTRUCTURA BODY

<b>A</b>	<b>Material</b>	Manguera fabricada en mandril de NR (caucho natural) monocapa de color avellana claro. Abrasion resistant beige natural rubber.
<b>B</b>	<b>Refuerzos</b>	---
	<b>Superficie</b>	Lisa con impresión de tela. Smooth with fabric impression.
	<b>Dureza</b>	45 shore a ± 5
	<b>Carga de rotura</b>	150 kg/cm <sup>2</sup>
	<b>Alargamiento a la rotura</b>	500%



#### ABRAZADERAS Y COLLARES DE APRIETE RECOMENDADOS RECOMMENDED CLAMP/COLLAR

STC - Abrazaderas con perno Hose clamps with bolt (pag. 208-210)



mm	mm	bar	gr/mt	mm	m
50 × 58	4	-	0,71	-	12
60 × 68	4	-	0,84	-	12
70 × 78	4	-	0,98	-	12
76 × 84	4	-	1,05	-	12
80 × 88	4	-	1,10	-	12
90 × 98	4	-	0,90	-	12
102 × 110	4	-	1,33	-	12
114 × 122	4	-	1,48	-	12
120 × 128	4	-	1,57	-	12
130 × 138	4	-	1,69	-	12
140 × 148	4	-	1,82	-	12
152 × 160	4	-	1,96	-	12
168 × 176	4	-	2,16	-	12
193 × 201	4	-	2,48	-	9
200 × 208	4	-	2,56	-	12
220 × 228	4	-	2,81	-	6
254 × 262	4	-	3,24	-	12
273 × 281	4	-	3,47	-	10
305 × 313	4	-	3,90	-	12
323 × 331	4	-	4,14	-	6
350 × 358	4	-	4,45	-	6
400 × 408	4	-	5,10	-	7
500 × 508	4	-	6,19	-	6
612 × 620	4	-	7,80	-	6



**NORMAS** NORMS:  
ISO 1307

**EMBALAJE** BOX:  
ROLLOS CORTADOS A MEDIDA  
ROLLS CUT TO SIZE



**-40°C / +70°C**  
**-40°F / +158°F**



- **Capa exterior especialmente resistente a los agentes atmosféricos.**  
Wear resistant cover.

### RUBBER



#### USO APPLICATIONS

Se utiliza habitualmente como revestimiento de tambores metálicos en la industria de bandas transportadoras, o como protección de superficies metálicas. Especialmente indicada para ofrecer una resistencia moderada a la abrasión y al desgarro, y unas características físicas y mecánicas discretas.

Commonly used as a coating on metal drums in the conveyor belt sector or to protect metal surfaces. In particular, it is indicated to offer fair resistance against abrasion and laceration. It has fair physical and mechanical characteristics.



#### ESTRUCTURA BODY

**A**  
**Material** Material Manguera fabricada en mandril de dos capas; capa interior en caucho natural (NR) capa exterior en caucho BR/EPDM de color negro. Abrasion resistant 2 tone natural rubber light brown inside black outside.

**B**  
**Refuerzos** ---  
**Reinforcement**

**Superficie** Surface Lisa con impresión de tela.  
Smooth with fabric impression.

**Color** Color Avellana claro por dentro, negro por fuera.  
Light hazelnut interior, black exterior.

**Dureza** Hardness 45 shore a ± 5

**Carga de rotura** Breaking strenght 150 kg/cm<sup>2</sup>

**Alargamiento a la rotura** Breaking elongation 400%



#### ABRAZADERAS Y COLLARES DE APRIETE RECOMENDADOS RECOMMENDED CLAMP/COLLAR

STC - Abrazaderas con perno Hose clamps with bolt (pag. 208-210)



mm	mm	bar	gr/mt	mm	m
50 × 58	4	-	0,75	-	12
60 × 68	4	-	0,88	-	12
70 × 78	4	-	1,02	-	12
76 × 84	4	-	1,07	-	12
80 × 88	4	-	1,16	-	12
90 × 98	4	-	1,27	-	12
102 × 110	4	-	1,44	-	12
114 × 122	4	-	1,60	-	12
120 × 128	4	-	1,68	-	12
130 × 138	4	-	1,83	-	12
140 × 148	4	-	1,95	-	12
152 × 160	4	-	2,11	-	12
168 × 176	4	-	2,32	-	12
193 × 201	4	-	2,68	-	9
200 × 208	4	-	2,76	-	12
220 × 228	4	-	3,03	-	6
254 × 262	4	-	3,50	-	12
273 × 281	4	-	3,74	-	10
305 × 313	4	-	4,20	-	12
323 × 331	4	-	4,42	-	6
350 × 358	4	-	4,81	-	6
400 × 408	4	-	5,52	-	7
500 × 508	4	-	6,81	-	6
612 × 620	4	-	8,50	-	6



**NORMAS** NORMS:  
ISO 1307  
**EMBALAJE** BOX:  
ROLLOS CORTADOS A MEDIDA  
ROLLS CUT TO SIZE



**-40°C / +70°C**  
**-40°F / +158°F**



# MANGUERAS PARA GAS Y SOLDADURA

GAS AND HOSES







**RUBBER**



**USO APPLICATIONS**

Para la conducción de oxígeno en equipos de soldadura en los que se requiere ligereza y flexibilidad. La manguera cumple con la normativa europea EN ISO 3821.

For oxygen conduction on soldering equipments where lightness and flexibility are requested. The hose is EN ISO 3821 approved.



- **Máxima ligereza y flexibilidad.**  
Maximum lightness and flexibility.
- **Conforme con la normativa europea EN ISO 3821.**  
EN ISO 3821 approved.



**ESTRUCTURA BODY**

<b>A</b>	<b>Capa interior Tube</b>	Caucho sintético negro liso. Black smooth synthetic rubber.
<b>B</b>	<b>Refuerzos Reinforcement</b>	Textiles sintéticos. High tensile synthetic textile.
<b>C</b>	<b>Capa exterior Cover</b>	Caucho sintético de color azul resistente a la abrasión y a los agentes atmosféricos. Abrasion, weather and flame resistant special blue synthetic rubber.
	<b>Superficie Surface</b>	Lisa. Smooth.



**ABRAZADERAS Y COLLARES DE APRIETE RECOMENDADOS**  
**RECOMMENDED CLAMP/COLLAR**

STF - Abrazaderas de tornillo Hose clamps with screw (pag. 204-207)  
SGT - Abrazaderas pinzables Stepp less (pag. 216)



mm	mm	bar	bar	bar	gr/mt	mm	m
5	10,5	20	60	-	110	50	100
6	13	20	60	-	140	60	100
8	15	20	60	-	180	80	100
8	16	20	60	-	190	80	100
8	17	20	60	-	270	80	100
10	17	20	60	-	240	100	100



**NORMAS** NORMS:  
ISO 1307 - UNI EN 559 DIN EN ISO 3821  
**MARCADOR** MARKING:  
ISO 3821 - 2 MPA (20 BAR) - (DIAM) - EUROCORD® OXYGEN (YEAR)  
**EMBALAJE** BOX:  
EMBALAJE EN POLIETILENO TRANSPARENTE  
PACKAGING IN TRANSPARENT POLYETHYLENE



**-30°C / +80°C**  
**-22°F / +176°F**



**RUBBER**



- **Máxima ligereza y flexibilidad.**  
Maximum lightness and flexibility.
- **Conforme con la normativa europea EN ISO 3821.**  
EN ISO 3821 approved.

**USO APPLICATIONS**

Para la conducción de oxígeno en equipos de soldadura en los que se requiere ligereza y flexibilidad. La manguera cumple con la normativa europea EN ISO 3821.

For oxigen conduction on soldering equipments where lightness and flexibility are requested. The hose is EN ISO 3821 approved.



**ESTRUCTURA BODY**

<b>A</b>	<b>Capa interior Tube</b>	Caucho sintético negro liso. Black smooth synthetic rubber.
<b>B</b>	<b>Refuerzos Reinforcement</b>	Textiles sintéticos. High tensile synthetic textile.
<b>C</b>	<b>Capa exterior Cover</b>	Caucho sintético rojo resistente a la abrasión y a los agentes atmosféricos. Abrasion, weather and flame resistant special red synthetic rubber.
	<b>Superficie Surface</b>	Lisa. Smooth.

mm	mm	bar	bar	bar	gr/mt	mm	m
5	10,5	20	60	-	110	50	100
6	13	20	60	-	140	60	100
8	15	20	60	-	180	80	100
8	16	20	60	-	190	80	100
8	17	20	60	-	270	80	100
10	17	20	60	-	240	100	100

**ABRAZADERAS Y COLLARES DE APRIETE RECOMENDADOS**  
**RECOMMENDED CLAMP/COLLAR**

STF - Abrazaderas de tornillo Hose clamps with screw (pag. 204-207)  
SGT - Abrazaderas pinzables Stepp less (pag. 216)



**NORMAS NORMS:**  
ISO 1307 - UNI EN 559 - DIN EN ISO 3821  
**MARCADOR MARKING:**  
ISO 3821 - 2 MPA (20 BAR) - (DIAM) - EUROCORD® ACETYLENE (YEAR)  
**EMBALAJE BOX:**  
EMBALAJE EN POLIETILENO TRANSPARENTE  
PACKAGING IN TRANSPARENT POLYETHYLENE



**-30°C / +80°C**  
**-22°F / +176°F**



**RUBBER**



- **Máxima ligereza y flexibilidad.**  
Maximum lightness and flexibility.
- **Conforme con la normativa europea EN ISO 3821.**  
EN ISO 3821 approved.



**USO APPLICATIONS**

Para la conducción de oxígeno en equipos de soldadura en los que se requiere ligereza y flexibilidad. La manguera cumple con la normativa europea EN ISO 3821.

For oxigen conduction on soldering equipments where lightness and flexibility are requested. The hose is EN ISO 3821 approved.



**ESTRUCTURA BODY**

<b>A</b>	<b>Capa interior Tube</b>	Caucho sintético negro liso. Black smooth synthetic rubber.
<b>B</b>	<b>Refuerzos Reinforcement</b>	Textiles sintéticos. High tensile synthetic textile.
<b>C</b>	<b>Capa exterior Cover</b>	Caucho sintético azul y rojo resistente a la abrasión y a los agentes atmosféricos. Abrasion, weather and flame resistant special synthetic rubber.
	<b>Superficie Surface</b>	Lisa. Smooth.



**ABRAZADERAS Y COLLARES DE APRIETE RECOMENDADOS**  
**RECOMMENDED CLAMP/COLLAR**

STF - Abrazaderas de tornillo Hose clamps with screw (pag. 204-207)  
SGT - Abrazaderas pinzables Stepp less (pag. 216)



mm	mm	bar	bar	bar	gr/mt	mm	m
5+5	10,5	20	60	-	270	40	100
6+6	13	20	60	-	289	48	100
8+8	15	20	60	-	420	64	100
10+10	17	20	60	-	490	80	100



**NORMAS** NORMS:  
ISO 1307 - UNI EN 559 DIN EN ISO 3821  
**MARCADOR** MARKING:  
ISO 3821 - 2 MPA (20 BAR) - (DIAM) - EUROCORD®  
BINATO (YEAR)  
**EMBALAJE** BOX:  
EMBALAJE EN POLIETILENO TRANSPARENTE  
PACKAGING IN TRANSPARENT POLYETHYLENE



**-30°C / +80°C**  
**-22°F / +176°F**



RUBBER



- **Máxima ligereza y flexibilidad.**  
Maximum lightness and flexibility.
- **Conforme con la normativa europea EN ISO 3821.**  
EN ISO 3821 approved.

### USO APPLICATIONS

Adecuada para la conducción de propano en equipos de soldadura donde se requiera ligereza y flexibilidad. La manguera cumple con la normativa europea EN ISO 3821.

For propane conduction on soldering equipments where lightness and flexibility are requested. The hose is EN ISO 3821 approved.



### ESTRUCTURA BODY

<b>A</b> Capa interior Tube	Lisa en caucho NBR de color negro. Black smooth synthetic rubber.
<b>B</b> Refuerzos Reinforcement	Textiles sintéticos. High tensile synthetic textile.
<b>C</b> Capa exterior Cover	Caucho SBR/EPDM de color naranja resistente a la abrasión y a los agentes atmosféricos. Abrasion, weather and flame resistant special synthetic rubber.
Superficie Surface	Lisa. Smooth.

mm	mm	bar	bar	bar	gr/mt	mm	m
6	12	20	60	-	130	60	100
8	14	20	60	-	160	80	100
8	15	20	60	-	180	80	100
8	16	20	60	-	190	80	100
8	17	20	60	-	270	80	100

### ABRAZADERAS Y COLLARES DE APRIETE RECOMENDADOS RECOMMENDED CLAMP/COLLAR

- STF - Abrazaderas de tornillo Hose clamps with screw (pag. 204-207)  
SGT - Abrazaderas pinzables Stepp less (pag. 216)



**NORMAS NORMS:**  
ISO 1307 - UNI EN 559 - DIN EN ISO 3821  
**MARCADOR MARKING:**  
ISO 3821 - 2 MPA (20 BAR) - (DIAM) - EUROCORD® PROPANO (YEAR)  
**EMBALAJE BOX:**  
EMBALAJE EN POLIETILENO TRANSPARENTE  
PACKAGING IN TRANSPARENT POLYETHYLENE



**-30°C / +80°C**  
**-22°F / +176°F**



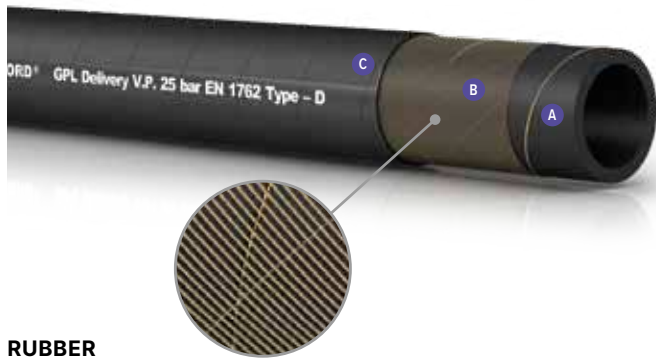

**RUBBER**



**USO APPLICATIONS**

Normalmente se utiliza para acompañar a los camiones cisterna en la descarga de GLP en las estaciones de servicio. Conforme con la norma EN 1762.

Normally used in support of tankers for the LPG delivery on the service stations. EN 1762 approved.



**ESTRUCTURA BODY**

<b>A</b> Capa interior Tube	Caucho NBR negro, resistente a los GLP y conductor. LPG resistant, conductive black NBR rubber.
<b>B</b> Refuerzos Reinforcement	Textiles sintéticos de alta tenacidad, hilo de cobre. High tensile synthetic textile and antistatic copper wire.
<b>C</b> Capa exterior Cover	Caucho sintético negro especial microperforado resistente al aceite, la llama, el ozono, la abrasión y los agentes atmosféricos. Ozone, weather, heat, flame and oil resistant, special pin-pricked synthetic rubber.
Superficie Surface	Lisa con impresión de tela. Smooth with fabric impression.











**ABRAZADERAS Y COLLARES DE APRIETE RECOMENDADOS  
RECOMMENDED CLAMP/COLLAR**

STF - Abrazaderas de tornillo Hose clamps with screw (pag. 204-207)  
STC - Abrazaderas con perno Hose clamps with bolt (pag. 208-210)



- **Conforme con la normativa europea EN 1762.**  
EN1762 approved.



 mm	 mm	 bar	 bar	 bar	 gr/mt	 mm	 m
13	23	25	100	-	382	100	40
16	26	25	100	-	450	125	40
19	31	25	100	-	590	160	40
25	38	25	100	-	780	200	40
32	45	25	100	-	987	250	40
38	52	25	100	-	1256	320	40
50	67	25	100	-	1854	400	40



**NORMAS** NORMS:  
EN 1762 TYPE-D  
**MARCADOR MARKING:**  
EUROCORD® GPL DELIVERY W.P. 25 BAR EN 1762 TYPE-D  
**EMBALAJE** BOX:  
EMBALAJE EN POLIETILENO NEGRO  
PACKAGING IN BLACK POLYETHYLENE



**-30°C / +70°C**  
**-22°F / +158°F**

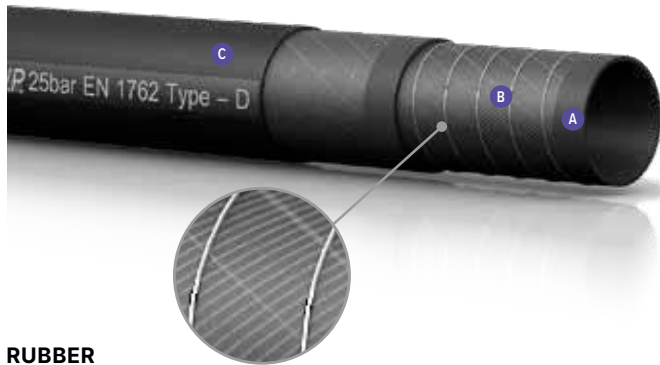

**RUBBER**



- **Conforme con la normativa europea EN 1762. EN1762 approved.**

**USO APPLICATIONS**

Normalmente se utiliza para acompañar a los camiones cisterna en la descarga de GPL en las estaciones de servicio. Conforme con la norma EN 1762.

Normally used in support of tankers for the LPG delivery on the service stations. EN 1762 approved.



**ESTRUCTURA BODY**

<b>A</b> Capa interior Tube	Caucho NBR negro, resistente a los GPL y conductor. LPG resistant, conductive black NBR rubber.
<b>B</b> Refuerzos Reinforcement	Textiles sintéticos de alta tenacidad, hilo de cobre. High tensile synthetic textile and antistatic copper wire.
<b>C</b> Capa exterior Cover	Caucho sintético negro especial microperforado resistente al aceite, la llama, el ozono, la abrasión y los agentes atmosféricos. Ozone, weather, heat, flame and oil resistant, special pin-pricked synthetic rubber.
<b>Superficie Surface</b>	Lisa con impresión de tela. Smooth with fabric impression.

mm	mm	bar	bar	bar	gr/mt	mm	m
13	23	25	100	0,8	434	90	40
16	26	25	100	0,8	499	95	40
19	31	25	100	0,8	669	100	40
25	38	25	100	0,8	868	150	40
32	45	25	100	0,8	1136	200	40
38	52	25	100	0,8	1584	280	40
50	67	25	100	0,8	2268	350	40

**ABRAZADERAS Y COLLARES DE APRIETE RECOMENDADOS RECOMMENDED CLAMP/COLLAR**

- STF - Abrazaderas de tornillo Hose clamps with screw (pag. 204-207)
- STC - Abrazaderas con perno Hose clamps with bolt (pag. 208-210)



**NORMAS NORMS:**  
EN 1762 TYPE-D  
**MARCADOR MARKING:**  
EUROCORD® GPL DELIVERY W.P. 25 BAR EN 1762 TYPE-D  
**EMBALAJE BOX:**  
EMBALAJE EN POLIETILENO NEGRO  
PACKAGING IN BLACK POLYETHYLENE

**-30°C / +70°C**  
**-22°F / +158°F**



**RUBBER**



**USO  
APPLICATIONS**

Adecuada para el paso a baja presión de gases licuados en fase gaseosa en kits para automóviles. Su ligereza y flexibilidad facilitan el montaje en espacios reducidos.

Suitable for the low pressure of liquefied gas on the car kit. Its lightness and flexibility help the installation on small places.



**ESTRUCTURA  
BODY**

<b>A</b> <b>Capa interior Tube</b>	Caucho sintético NBR negro, liso e impermeable. LPG resistant, conductive black NBR rubber.
<b>B</b> <b>Refuerzos Reinforcement</b>	Textiles sintéticos de alta resistencia. High tensile synthetic textile.
<b>C</b> <b>Capa exterior Cover</b>	Caucho sintético CSM resistente a la abrasión, el calor, los agentes atmosféricos y el ozono. Ozone, weather, heat, flame and oil resistant, special pin-pricked synthetic rubber.
<b>Superficie Surface</b>	Lisa. Smooth.











**ABRAZADERAS Y COLLARES DE APRIETE  
RECOMENDADOS  
RECOMMENDED CLAMP/COLLAR**

STF - Abrazaderas de tornillo Hose clamps with screw (pag. 204-207)  
STM - Abrazaderas de apriete Hose clamps (pag. 213)  
SGT - Abrazaderas pinzables Stepp less (pag. 216)



- **Ligero y flexible.**  
Light and flexible.
- **Fácil instalación en espacios reducidos.**  
Easy to install in small places.



 mm	 mm	 bar	 bar	 bar	 gr/mt	 mm	 m
4	10	4,5	10	-	85	40	50
5	10,5	4,5	10	-	90	50	50
6	13	4,5	10	-	135	60	50
8	15	4,5	10	-	165	80	50
10	17	4,5	10	-	200	100	50
11	19	4,5	10	-	250	110	50
12	19	4,5	10	-	225	120	50
14	22	4,5	10	-	300	140	50
17	24	4,5	10	-	300	170	50
19	27	4,5	10	-	385	190	50



**NORME NORMS:**  
ECE REG.110.00, ANNEX 4B, CLASS 2, ECE R67,01,  
ANNEX 8, CLASS 2, ISO 1307

**MARCATURA MARKING:**  
EUROCORD® LPG E 13 67R  
CLASS 2 CNG E 13 110R CLASS 2 (LOT)

**EMBALAJE BOX:**  
EMBALAJE EN POLIETILENO TRANSPARENTE  
PACKAGING IN TRANSPARENT POLYETHYLENE



**-40°C / +125°C**  
**-40°F / +257°F**



**RUBBER**

**USO APPLICATIONS**









Para conducir argón cuando se requiere ligereza y flexibilidad. La manguera cumple la normativa europea EN ISO 3821.

For argon delivery in welding machines. According to European Reg. EN ISO3821.



**ESTRUCTURA BODY**

<b>A</b> Capa interior Tube	Lisa en caucho EPDM de color negro. Smooth black EPDM rubber.
<b>B</b> Refuerzos Reinforcement	Textiles sintéticos. High tensile synthetic textile.
<b>C</b> Capa exterior Cover	Caucho EPDM negro, resistente a la abrasión y a los agentes atmosféricos. Weather, ozone and abrasion resistant EPDM rubber.
Superficie Surface	Lisa. Smooth.

 mm	 mm	 bar	 bar	 bar	 gr/mt	 mm	 m
5	11	20	60	-	120	50	100
6,3	12,3	20	60	-	140	60	100
13	21	20	60	-	298	130	50
15	25	20	60	-	440	150	50

**ABRAZADERAS Y COLLARES DE APRIETE RECOMENDADOS RECOMMENDED CLAMP/COLLAR**

STF - Abrazaderas de tornillo Hose clamps with screw (pag. 204-207)  
SGT - Abrazaderas pinzables Stepp less (pag. 216)



**NORMAS NORMS:**  
UNI EN 559, DIN EN ISO 3821, ISO 1307

**MARCADOR MARKING:**  
ISO 3821 2 MPA (20 BAR) - (DIAM) - EUROCORD® ARGON (YEAR)

**EMBALAJE BOX:**  
EMBALAJE EN POLIETILENO TRANSPARENTE  
PACKAGING IN TRANSPARENT POLYETHYLENE

**-20°C / +70°C**  
**-4°F / +158°F**



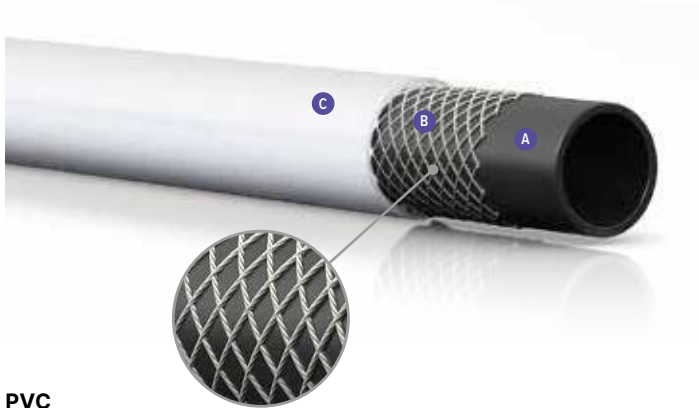

PVC



- **Ideal para entrega de gas metano para uso doméstico.**  
Suitable for delivery of natural gas for domestic use.



**USO  
APPLICATIONS**

Para entrega de gas metano para uso doméstico. Preferiblemente para ser utilizada como conexión de la red de distribución de gas a los aparatos domésticos. Fabricada según las normas UNI 7140:2013 para la seguridad de los aparatos domésticos de gas.

For delivery of natural gas for domestic use. Preferably used for the connection of the gas distribution network to domestic appliances. Product according to UNI 7140: 2013 standards for the safety of domestic gas appliances.



**ESTRUCTURA  
BODY**

<b>A</b>	<b>Capa interior Tube</b>	Lisa en PVC de color negro. Smooth black PVC.
<b>B</b>	<b>Refuerzos Reinforcement</b>	Fibras textiles de poliéster, sintéticas. High tensile synthetic textile.
<b>C</b>	<b>Capa exterior Cover</b>	PVC de color blanco. White PVC.
	<b>Superficie Surface</b>	Lisa. Smooth.

mm	mm	bar	bar	bar	gr/mt	mm	m
13	20	0,2	30	-	195	-	50



**ABRAZADERAS Y COLLARES DE APRIETE  
RECOMENDADOS  
RECOMMENDED CLAMP/COLLAR**

STF - Abrazaderas de tornillo Hose clamps with screw (pag. 204-207)  
SGT - Abrazaderas pinzables Stepp less (pag. 216)



**NORMAS** NORMS:  
UNI 7140 CL 1 TIPO A1  
**MARCADOR** MARKING:  
UNI 7140 CL 1 TIPO A1



**-40°C / +90°C**  
**-40°F / +194°F**

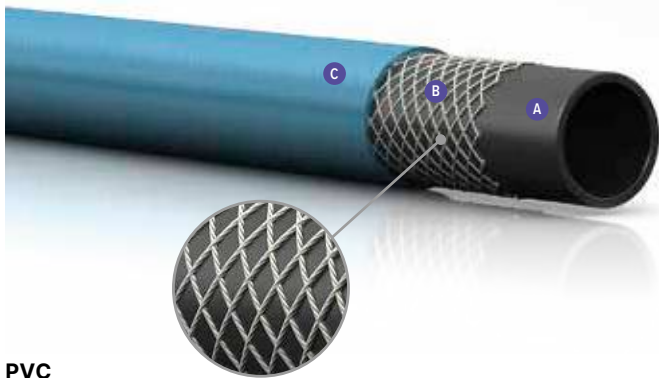

PVC



- **Ideal para entrega de gas GPL para uso doméstico.**  
Suitable for delivery of LPG for domestic use.



**USO**  
**APPLICATIONS**

Para entrega de gas GPL para uso doméstico. Se utiliza preferentemente como conexión entre la bombona y los aparatos domésticos de gas. Fabricada según las normas UNI CIG 7140 para la seguridad de los aparatos domésticos de gas.









For delivery of LPG gas for domestic use. To be used preferably as a connection between the cylinder and domestic gas appliances. Produced according to UNI CIG 7140 standards for the safety of domestic gas appliances.



**ESTRUCTURA**  
**BODY**

<b>A</b>	<b>Capa interior Tube</b>	Lisa en PVC de color negro. Smooth black PVC.
<b>B</b>	<b>Refuerzos Reinforcement</b>	Fibras textiles de poliéster, sintéticas. High tensile synthetic textile.
<b>C</b>	<b>Capa exterior Cover</b>	PVC azul claro. Light blue PVC.
	<b>Superficie Surface</b>	Lisa. Smooth.



 mm	 mm	 bar	 bar	 bar	 gr/mt	 mm	 m
8	13	0,2	30	-	195	-	100



**ABRAZADERAS Y COLLARES DE APRIETE**  
**RECOMENDADOS**  
**RECOMMENDED CLAMP/COLLAR**

STF - Abrazaderas de tornillo Hose clamps with screw (pag. 204-207)  
SGT - Abrazaderas pinzables Stepp less (pag. 216)



**NORMAS** NORMS:  
UNI 7140 CL 1 TIPO A1  
ISO 1307 REG. UE 10/2011 SIMULANT A,B,C, D2 E E  
**MARCADOR** MARKING:  
UNI CIG 7140



**-40°C / +90°C**  
**-40°F / +194°F**

# MANGUERAS PARA ACERERÍAS

STEEL MILL HOSES

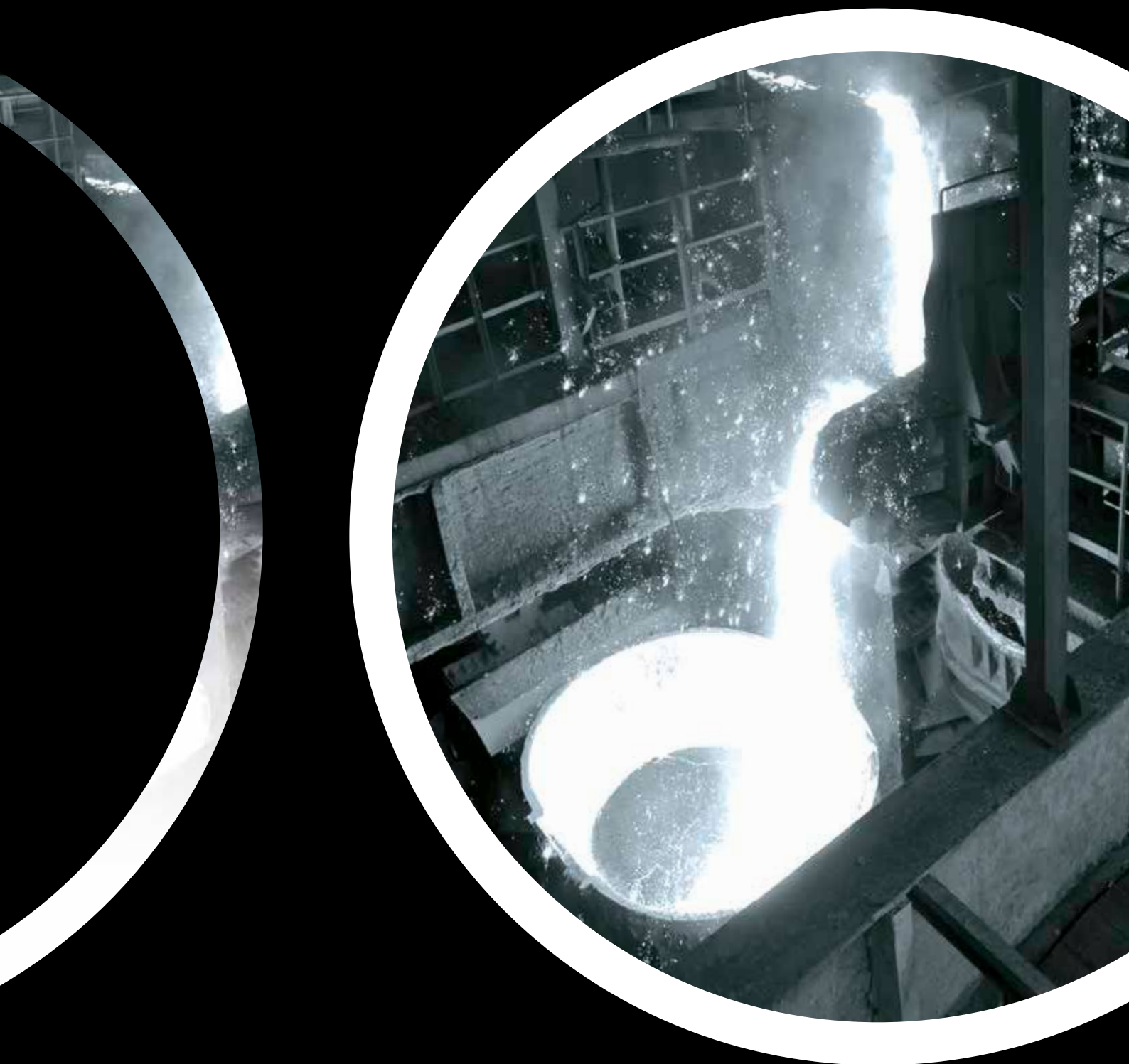
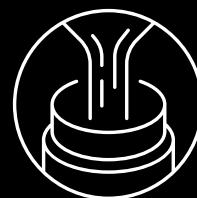

# ACQUA HD 40

## AUTOEXTINGUIBLE SELF-EXTINGUISHING

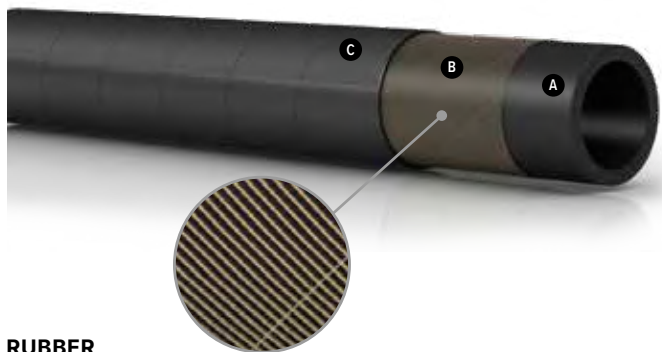

**RUBBER**



### USO APPLICATIONS

Solo entrega de líquidos o gases técnicos como nitrógeno, hidrógeno, oxígeno y otros; para aplicaciones en las que se requiera la no propagación de la llama.

For the delivery only of liquids or of technical gas as nitrogen, hydrogen, oxygen and others; for applications where the flame must not propagate.



### ESTRUCTURA BODY

<b>A</b> Capa interior Tube	Mezcla negra autoextinguible según ASTM C542, a base de CR. Black self-extinguishing compound according to ASTM C542, CR rubber.
<b>B</b> Refuerzos Reinforcement	Tejidos sintéticos de alta tenacidad. High tensile synthetic textile.
<b>C</b> Capa exterior Cover	Mezcla negra autoextinguible según ASTM C542, a base de CR. Black self-extinguishing compound according to ASTM C542, CR rubber.
Superficie Surface	Lisa con impresión de tela. Smooth with fabric impression.



### ABRAZADERAS Y COLLARES DE APRIETE RECOMENDADOS RECOMMENDED CLAMP/COLLAR

STF - Abrazaderas de tornillo Hose clamps with screw (pag. 204-207)

STC - Abrazaderas con perno Hose clamps with bolt (pag. 208-210)



mm	mm	bar	bar	bar	gr/mt	mm	m
10	17	40	120	-	250	60	-
13	22	40	120	-	370	90	-
32	47	40	120	-	1350	190	-
38	54	40	120	-	1720	240	-



NORMAS NORMS: ISO 1307

MARCADOR MARKING: --

EMBALAJE BOX:  
EMBALAJE EN POLIETILENO NEGRO  
PACKAGING IN BLACK POLYETHYLENE



**-30°C / +80°C**  
**-22°F / +176°F**



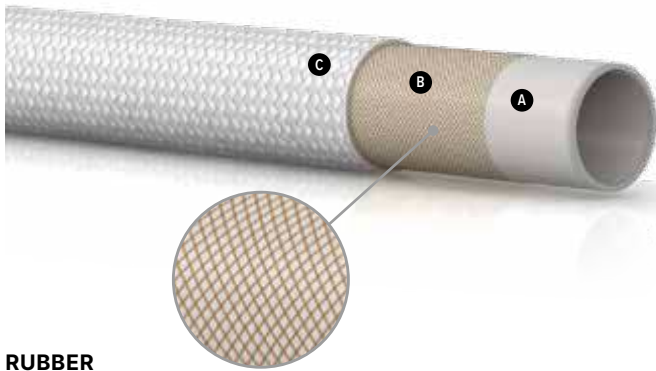

**RUBBER**



- **Estructura en fibra de vidrio tipo E-550°C.**  
**Fiber glass structure type E-550°C.**
- **Proporciona un elevado aislamiento eléctrico.**  
**Allow an high electric isolation.**



**USO**  
**APPLICATIONS**

Entrega de líquido o gas solo en instalaciones donde se requiera un elevado aislamiento eléctrico y protección externa contra fuentes de calor radiante; aplicación típica en hornos eléctricos de fusión de acero.

For the delivery only of liquids or gas on plants where a high electric isolation and an external protection from radiant heat is requested; typical application on electric ovens of steel fusion.



**ESTRUCTURA**  
**BODY**

<b>A</b> Capa interior Tube	Mezcla blanca aislante de EPDM. White insulating EPDM compound.
<b>B</b> Refuerzos Reinforcement	Tejidos sintéticos de alta tenacidad. High tensile synthetic textile.
<b>C</b> Capa exterior Cover	Tejido en fibra de vidrio en bruto, tipo E-550°C. Raw fabric in glass-fibre, type E-550°C.
<b>Superficie Surface</b>	En fibra de vidrio. Glass fiber braid.

mm	mm	bar	bar	bar	gr/mt	mm	m
13	23	10	30	-	410	85	-
13	22	20	60	-	360	85	-
19	30	20	60	-	620	120	-
25	37	20	60	-	870	150	-
32	46	20	60	-	1290	190	-
38	53	20	60	-	1650	240	-
50	70	20	60	-	2850	300	-



**ABRAZADERAS Y COLLARES DE APRIETE**  
**RECOMENDADOS**  
**RECOMMENDED CLAMP/COLLAR**

STF - Abrazaderas de tornillo Hose clamps with screw (pag. 204-207)  
 STC - Abrazaderas con perno Hose clamps with bolt (pag. 208-210)



**NORMAS** NORMS:  
 ISO 1307  
**MARCADOR MARKING:** --  
**EMBALAJE** BOX:  
 EMBALAJE EN POLIETILENO NEGRO  
 PACKAGING IN BLACK POLYETHYLENE



**-30°C / +120°C**  
**-22°F / +248°F**

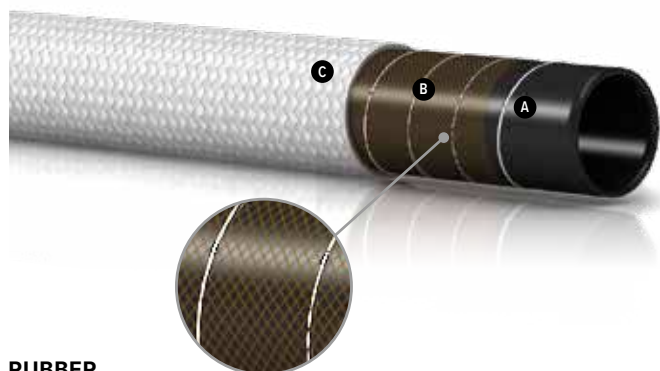

RUBBER



- Estructura en fibra de vidrio tipo E-550°C. Fiber glass structure type E-550°C.
- Proporciona un elevado aislamiento eléctrico. Allow an high electric isolation.

### USO APPLICATIONS

Manguera para entrega y aspiración de líquidos inertes en instalaciones donde se requiera protección externa contra fuentes de calor radiante; aplicación típica en hornos eléctricos de fusión de acero.

For the delivery only of liquids or gas on plants where a high electric isolation and an external protection from radiant heat is requested; typical application on electric ovens of steel fusion.



### ESTRUCTURA BODY

<b>A</b>	Mezcla negra SBR. Black SBR rubber.
<b>B</b>	Tejidos sintéticos de alta tenacidad. Espiral de acero incorporada. High tensile synthetic textile and steel wire helix.
<b>C</b>	Tejido en fibra de vidrio en bruto, tipo E-550°C. Raw fabric in glass-fibre, type E-550°C.
<b>Superficie Surface</b>	En fibra de vidrio. Glass fiber braid.

mm	mm	bar	bar	bar	gr/mt	mm	m
13	22	10	30	-	360	90	-
19	30	10	30	-	610	120	-
25	39	10	30	-	1020	150	-
32	46	10	30	-	1240	190	-
38	53	10	30	-	1550	230	-
50	68	10	30	-	2420	300	-
60	78	10	30	-	2830	360	-
75	93	10	30	-	3440	450	-
100	120	10	30	-	5050	600	-
125	148	10	30	-	7150	750	-
150	177	10	30	-	10150	900	-
200	232	10	30	-	15740	1200	-
250	286	10	30	-	21960	1500	-
75	93	20	60	-	3540	450	-
102	125	20	60	-	5980	600	-
127	149	20	60	-	6940	750	-
152	179	20	60	-	10270	900	-

### ABRAZADERAS Y COLLARES DE APRIETE RECOMENDADOS RECOMMENDED CLAMP/COLLAR

- STF - Abrazaderas de tornillo Hose clamps with screw (pag. 204-207)
- STC - Abrazaderas con perno Hose clamps with bolt (pag. 208-210)



**NORMAS NORMS:**  
ISO 1307

**MARCADOR MARKING:** --

**EMBALAJE BOX:**  
EMBALAJE EN POLIETILENO NEGRO  
PACKAGING IN BLACK POLYETHYLENE

**-30°C / +90°C**  
**-22°F / +194°F**

# CFV HD 40

## AUTOEXTINGUIBLE SELF-EXTINGUISHING

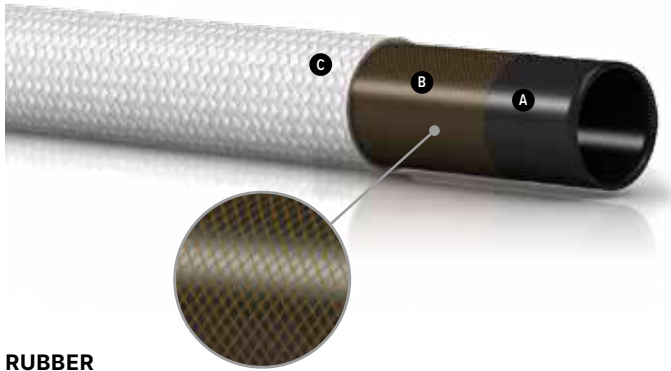

**RUBBER**



- **Estructura autoextinguible.**  
Self-extinguishes structure.
- **Permite protegerse de las fuentes de calor.**  
Allow the protection from heat sources.



### USO APPLICATIONS

Solo entrega de líquidos o gases técnicos como nitrógeno, hidrógeno, oxígeno y otros; para aplicaciones en las que se requiere la no propagación de la llama y la protección externa contra fuentes de calor radiante; aplicación típica en plantas siderúrgicas.

For the delivery only of liquids or gas on plants where a high electric isolation and an external protection from radiant heat is requested; typical application on electric ovens of steel fusion.



### ESTRUCTURA BODY

<b>A</b> Capa interior Tube	Mezcla negra autoextinguible según ASTM C542, a base de CR. Black self-extinguishing compound according to ASTM C542, CR rubber.
<b>B</b> Refuerzos Reinforcement	Tejidos sintéticos de alta tenacidad. High tensile synthetic textile.
<b>C</b> Capa exterior Cover	Tejido en fibra de vidrio en bruto, tipo E-550°C. Raw fabric in glass-fibre, type E-550°C.
Superficie Surface	En fibra de vidrio. Glass fiber braid.



### ABRAZADERAS Y COLLARES DE APRIETE RECOMENDADOS RECOMMENDED CLAMP/COLLAR

STF - Abrazaderas de tornillo Hose clamps with screw (pag. 204-207)  
STC - Abrazaderas con perno Hose clamps with bolt (pag. 208-210)



mm	mm	bar	bar	bar	gr/mt	mm	m
13	23	40	120	-	450	85	-
19	31	40	120	-	780	120	-
25	38	40	120	-	1050	150	-
32	47	40	120	-	1520	190	-
38	54	40	120	-	1850	240	-
50	70	40	120	-	2960	300	-
75	95	40	120	-	4200	450	-



**NORMAS** NORMS:  
ISO 1307  
**MARCADOR MARKING:** --  
**EMBALAJE** BOX:  
EMBALAJE EN POLIETILENO NEGRO  
PACKAGING IN BLACK POLYETHYLENE



**-30°C / +80°C**  
**-22°F / +176°F**



# MANGUERAS PARA EL PASO DE PRODUCTOS QUÍMICOS

CHEMICAL DELIVERY HOSES





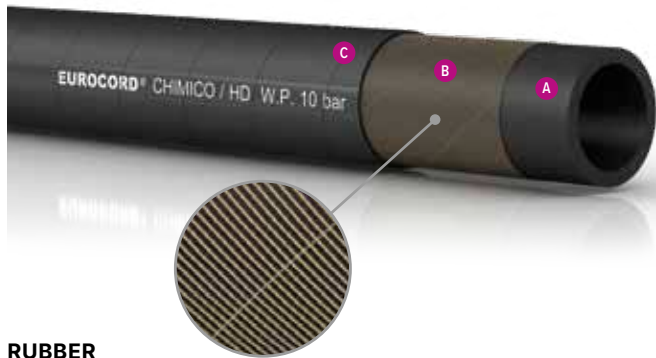

**RUBBER**



**USO  
APPLICATIONS**

Adecuada para entrega de disolventes, ácidos orgánicos e inorgánicos, sales, bases, cetonas a altas concentraciones.

For discharge wide range of chemicals sea and industrial water.



**ESTRUCTURA  
BODY**

<b>A</b> Capa interior Tube	Caucho EPDM negro liso resistente a disolventes y productos químicos. Chemical resistant black EPDM rubber.
<b>B</b> Refuerzos Reinforcement	Tejidos textiles sintéticos de alta resistencia. High tensile synthetic textile.
<b>C</b> Capa exterior Cover	Caucho EPDM/SBR resistente a los disolventes, a los productos químicos, a la abrasión y a los agentes atmosféricos. Weather, ozone and abrasion resistant EPDM rubber.
Superficie Surface	Lisa con impresión de tela. Smooth with fabric impression.











**ABRAZADERAS Y COLLARES DE APRIETE  
RECOMENDADOS  
RECOMMENDED CLAMP/COLLAR**

STF - Abrazaderas de tornillo Hose clamps with screw (pag. 204-207)  
STC - Abrazaderas con perno Hose clamps with bolt (pag. 208-210)



- **Excelente resistencia a los productos químicos.**  
Excellent chemicals products resistance.



 mm	 mm	 bar	 bar	 bar	 gr/mt	 mm	 m
10	18	10	30	-	180	100	40
12	20	10	30	-	210	120	40
15	25	10	30	-	250	150	40
18	28	10	30	-	280	180	40
20	29	10	30	-	320	200	40
25	34	10	30	-	420	250	40
30	42	10	30	-	700	300	40
35	48	10	30	-	850	350	40
40	55	10	30	-	1050	400	40
45	62	10	30	-	1370	450	40
51	66	10	30	-	1490	510	40
60	76	10	30	-	2400	600	40



**NORMAS** NORMS:  
ISO 1307  
**MARCADOR** MARKING:  
EUROCORD® CHIMICO HD W.P. 10 BAR  
**EMBALAJE** BOX:  
EMBALAJE EN POLIETILENO TRANSPARENTE  
PACKAGING IN TRANSPARENT POLYETHYLENE



**-40°C / +120°C**  
**-40°F / +248°F**

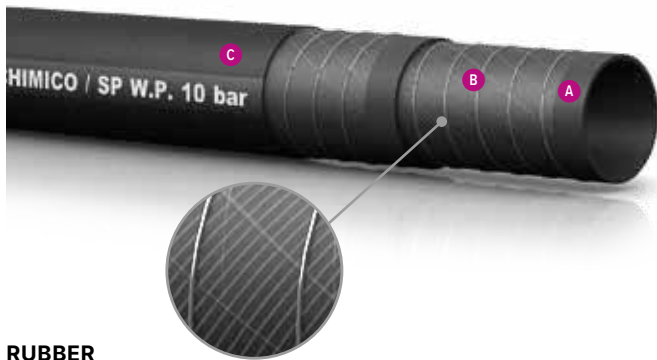

**RUBBER**



- **Doble espiral para mayor flexibilidad.**  
Extremely flexible thanks to the double spiral.
- **Radios de curvatura excepcionalmente estrechos.**  
Exceptionally tight banding radiuses.

**USO APPLICATIONS**

Para aspiración y entrega de disolventes, ácidos orgánicos e inorgánicos, sales, bases, cetonas de alta concentración. La doble espiral confiere a la estructura de la manguera una flexibilidad especial que la hace muy manejable y le permite radios de curvatura excepcionalmente cerrados.

For discharge wide range of chemicals sea and industrial water. The double spiral guarantees an excellent flexibility to the structure of the hose. It is very handy and it permits exceptionally tight banding radiuses.



**ESTRUCTURA BODY**

<b>A</b> Capa interior Tube	Caucho EPDM negro liso resistente a disolventes y productos químicos. Chemical resistant black EPDM rubber.
<b>B</b> Refuerzos Reinforcement	Doble espiral metálica y tejidos textiles sintéticos. High tensile synthetic textile.
<b>C</b> Capa exterior Cover	Caucho EPDM SBR resistente a los disolventes, a los productos químicos, a la abrasión y a los agentes atmosféricos. Weather, ozone and abrasion resistant EPDM rubber.
Superficie Surface	Lisa con impresión de tela. Smooth with fabric impression.

mm	mm	bar	bar	bar	gr/mt	mm	m
30	42	10	30	0,7	720	180	40
35	48	10	30	0,7	860	210	40
40	53	10	30	0,7	1020	240	40
45	59	10	30	0,7	1250	270	40
51	64	10	30	0,7	1650	306	40
60	74	10	30	0,7	2150	360	40
70	86	10	30	0,7	2620	420	40
80	96	10	30	0,7	3400	480	40
102	120	10	30	0,7	4900	600	40
127	147	10	30	0,7	7550	762	40
152	175	10	30	0,7	12100	912	40
203	228	10	30	0,7	18000	1218	40

**ABRAZADERAS Y COLLARES DE APRIETE RECOMENDADOS**  
**RECOMMENDED CLAMP/COLLAR**

STF - Abrazaderas de tornillo Hose clamps with screw (pag. 204-207)  
STC - Abrazaderas con perno Hose clamps with bolt (pag. 208-210)



**NORMAS** NORMS:  
ISO 1307  
**MARCADOR** MARKING:  
EUROCORD® CHIMICO SP W.P. 10 BAR  
**EMBALAJE** BOX:  
EMBALAJE EN POLIETILENO TRANSPARENTE  
PACKAGING IN TRANSPARENT POLYETHYLENE



**-40°C / +120°C**  
**-40°F / +248°F**



**RUBBER**



**USO APPLICATIONS**

Adecuada para entrega y la aspiración de pinturas cuyos disolventes no contengan hidrocarburos aromáticos, clorados ni halogenados.

Suitable for delivery and suction of paints with solvents non containing aromatic, aliphatic and chlorinated hydrocarbons.



**ESTRUCTURA BODY**









<b>A</b> Capa interior Tube	Caucho liso negro resistente a la pintura. Black, smooth, paints resistant special rubber.
<b>B</b> Refuerzos Reinforcement	Espiral metálica incorporada y tejidos textiles sintéticos de alta resistencia. Steel wire helix with high strength synthetic textile plies.
<b>C</b> Capa exterior Cover	Caucho negro resistente a la abrasión, la pintura, el ozono y los agentes atmosféricos. Black, abrasion, paints, weathering and ozone, resistant rubber.
Superficie Surface	Lisa con impresión de tela. Smooth with fabric impression.



**ABRAZADERAS Y COLLARES DE APRIETE RECOMENDADOS RECOMMENDED CLAMP/COLLAR**

STC - Abrazaderas con perno Hose clamps with bolt (pag. 208-210)  
BANDI BLOCK - Par de apriete Tightening torque (pag. 221)



 mm	 mm	 bar	 bar	 bar	 gr/mt	 mm	 m
13	23	10	15	0,8	450	55	40
16	26	10	15	0,8	500	65	40
19	30	10	15	0,8	600	75	40
25	36	10	15	0,8	750	100	40



**NORMAS NORMS:**  
ISO 1307 - ISO 22241-2  
**MARCADOR MARKING:**  
EUROCORD® VERNICI/SP  
**EMBALAJE BOX:**  
EMBALAJE EN POLIETILENO TRANSPARENTE  
PACKAGING IN TRANSPARENT POLYETHYLENE



**-40°C / +100°C**  
**-40°F / +212°F**



**RUBBER**

- 
**Capa interior en U.H.M.W.P.E. no tóxico aprobado por FDA. UHMW-PE atoxic inner layer FDA approved.**

**USO APPLICATIONS**









Adecuada para el transporte de todos los líquidos alimentarios y diversos productos químicos; esta versatilidad la hace especialmente adecuada para las industrias farmacéutica, química y alimentaria.

For discharge of all corrosive chemicals, especially high aromatic solvents.



**ESTRUCTURA BODY**

<b>A</b> Capa interior Tube	En U.H.M.W.P.E. (Polietileno de peso molecular ultra alto) semitransparente, no tóxico aprobado por F.D.A. Translucent, food grade UHMW-PE liner FDA approved.
<b>B</b> Refuerzos Reinforcement	Tejidos en rayón de alta resistencia, hilo de cobre para disipar la electricidad estática. High tensile synthetic textile and antistatic copper wires.
<b>C</b> Capa exterior Cover	Caucho sintético amarillo liso de impresión en tela, resistente a los agentes atmosféricos, al ozono y a la abrasión. Weather, ozone, abrasion resistant EPDM rubber.
Superficie Surface	Lisa con impresión de tela. Smooth with fabric impression.

 mm	 mm	 bar	 bar	 bar	 gr/mt	 mm	 m
19	31	10	40	-	510	190	40
25	37	10	40	-	710	250	40
30	42	10	40	-	820	300	40
32	44	10	40	-	870	320	40
35	47	10	40	-	930	350	40
38	52	10	40	-	1130	380	40
40	54	10	40	-	1300	400	40
45	59	10	40	-	1470	450	40
51	65	10	40	-	1600	510	40
60	75	10	40	-	1930	600	40
63,5	78,5	10	40	-	2180	635	40
70	86	10	40	-	2460	700	40
76	94	10	40	-	2960	760	40
80	98	10	40	-	3100	800	20-40
102	122	10	40	-	3250	1020	20-40

**ABRAZADERAS Y COLLARES DE APRIETE RECOMENDADOS RECOMMENDED CLAMP/COLLAR**

STF - Abrazaderas de tornillo Hose clamps with screw (pag. 204-207)  
 STC - Abrazaderas con perno Hose clamps with bolt (pag. 208-210)



**NORMAS** NORMS:  
EN 12115 - TYPE SD

**MARCADOR** MARKING:  
EUROCORD® CORDLINKED HD W.P. 10 BAR

**EMBALAJE** BOX:  
EMBALAJE EN POLIETILENO TRANSPARENTE  
PACKAGING IN TRANSPARENT POLYETHYLENE

**-40°C / +80°C**  
**-40°F / +176°F**



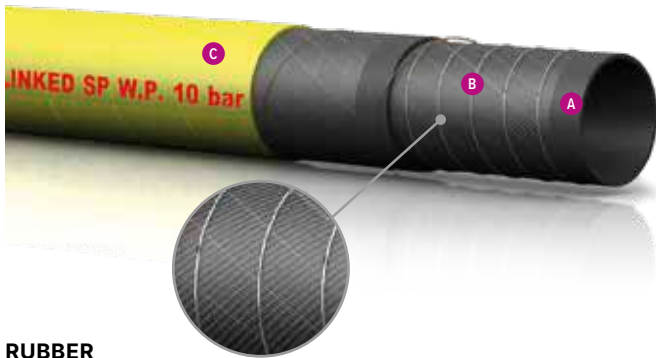

**RUBBER**



- **Capa interior en U.H.M.W.P.E. no tóxico aprobado por FDA.**  
UHMW-PE atoxic inner layer  
FDA approved.



**USO  
APPLICATIONS**

Adecuada para el transporte de todos los líquidos alimentarios y diversos productos químicos; esta versatilidad la hace especialmente adecuada para las industrias farmacéutica, química y alimentaria.

For suction and discharge of all corrosive chemicals, especially high aromatic solvents.



**ESTRUCTURA  
BODY**









<b>A</b> <b>Capa interior Tube</b>	En U.H.M.W.P.E. (Polietileno de peso molecular ultra alto) semitransparente, no tóxico aprobado por F.D.A. Translucent, food grade UHMW-PE liner FDA approved.
<b>B</b> <b>Refuerzos Reinforcement</b>	Tejidos en rayón de alta resistencia, hilo de cobre para disipar la electricidad estática, espiral metálica. High tensile synthetic textile and antistatic copper wires.
<b>C</b> <b>Capa exterior Cover</b>	Caucho sintético amarillo resistente a los agentes atmosféricos, al ozono y a la abrasión. Weather, ozone, abrasion resistant EPDM rubber.
<b>Superficie Surface</b>	Lisa con impresión de tela. Smooth with fabric impression.



**ABRAZADERAS Y COLLARES DE APRIETE  
RECOMENDADOS  
RECOMMENDED CLAMP/COLLAR**

STF - Abrazaderas de tornillo Hose clamps with screw (pag. 204-207)  
STC - Abrazaderas con perno Hose clamps with bolt (pag. 208-210)



 mm	 mm	 bar	 bar	 bar	 gr/mt	 mm	 m
19	30	10	40	0,7	510	120	40
25	36	10	40	0,7	760	150	40
30	42	10	40	0,7	1140	175	40
32	46	10	40	0,7	1190	180	40
35	49	10	40	0,7	1300	200	40
38	52	10	40	0,7	1460	220	40
40	54	10	40	0,7	1520	220	40
45	59	10	40	0,7	1710	260	40
51	66	10	40	0,7	2030	280	40
60	75	10	40	0,7	2550	350	40
63,5	78,5	10	40	0,7	2660	360	40
70	86	10	40	0,7	2930	420	40
76	94	10	40	0,7	3460	420	40
80	96	10	40	0,7	3500	460	20-40
102	120	10	40	0,7	4740	590	20-40



**NORMAS** NORMS:  
EN 12115 - TYPE SD  
**MARCADOR** MARKING:  
EUROCORD® CORDLINKED SP W.P. 10 BAR

**EMBALAJE** BOX:  
EMBALAJE EN POLIETILENO TRANSPARENTE  
PACKAGING IN TRANSPARENT POLYETHYLENE



**-40°C / +80°C**  
**-40°F / +176°F**



**RUBBER**



- **Para descargar productos químicos.**  
**For chemical products discharge.**

**USO**  
**APPLICATIONS**

Adecuada para entrega de disolventes, ácidos orgánicos e inorgánicos, sales, bases, cetonas a altas concentraciones.

For discharge wide range of chemicals sea and industrial water.



**ESTRUCTURA**  
**BODY**

<b>A</b> <b>Capa interior</b> Tube	Caucho EPDM negro resistente a los productos químicos. Chemical resistant black EPDM rubber.
<b>B</b> <b>Refuerzos</b> Reinforcement	Tejidos de alta tenacidad y 2 hilos de cobre antiestáticos. High tensile synthetic textile and 2 antistatic copper wire.
<b>C</b> <b>Capa exterior</b> Cover	Caucho EPDM negro, resistente a la abrasión y a los agentes atmosféricos. Weather, ozone and abrasion resistant EPDM rubber.
<b>Superficie</b> Surface	Lisa con impresión de tela. Smooth with fabric impression.

mm	mm	bar	bar	bar	gr/mt	mm	m
25	37	16	64	-	746	150	40/61
32	44	16	64	-	934	175	40/61
38	51	16	64	-	1200	225	40/61
50	67	16	64	-	1943	275	40/61
63,5	79	16	64	-	2306	300	40/61
76	92	16	64	-	2713	350	40/61
102	118	16	64	-	3721	450	40/61

**ABRAZADERAS Y COLLARES DE APRIETE**  
**RECOMENDADOS**  
**RECOMMENDED CLAMP/COLLAR**

STC - Abrazaderas con perno Hose clamps with bolt (pag. 208-210)



**NORMAS** NORMS:  
EN 12115 - TYPE D  
**MARCADOR** MARKING:  
EUROCORD® CHIMICO HD W.P. 10 BAR  
**EMBALAJE** BOX:  
EMBALAJE EN POLIETILENO NEGRO  
PACKAGING IN BLACK POLYETHYLENE



**-40°C / +120°C**  
**-40°F / +248°F**

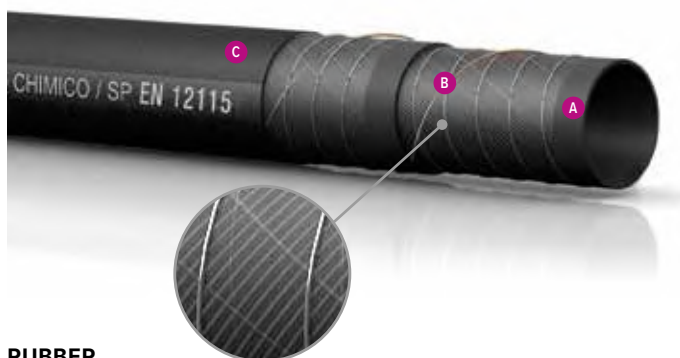

RUBBER



- Para la aspiración y entrega de ácidos.  
For suction and delivery of acids.



### USO APPLICATIONS

Para la aspiración y entrega de ácidos, alcaloides, sales, compuestos orgánicos (alcoholes, cetonas, ésteres, etc.), incluidas sustancias aromáticas, hidrocarburos clorados y ácidos oxidantes.

For suction and delivery of acids, alkaloids, salts, organic compounds (alcoholic, ketone, ester, etc.) including aromatics substances, chlorinated hydrocarbons and oxidizing acids.



### ESTRUCTURA BODY

<b>A</b> Capa interior Tube	Caucho EPDM negro resistente a los productos químicos. Chemical resistant black EPDM rubber.
<b>B</b> Refuerzos Reinforcement	Tejidos de alta tenacidad, 2 espirales de acero, 2 cordones de cobre antiestáticos. High tensile synthetic textile, 2 steel wire helix and 2 antistatic coppers wire.
<b>C</b> Capa exterior Cover	Caucho EPDM negro, conductor, resistente a la abrasión y a los agentes atmosféricos. Weather, ozone and abrasion resistant EPDM rubber.
Superficie Surface	Lisa con impresión de tela. Smooth with fabric impression.



### ABRAZADERAS Y COLLARES DE APRIETE RECOMENDADOS RECOMMENDED CLAMP/COLLAR

STC - Abrazaderas con perno Hose clamps with bolt (pag. 208-210)



mm	mm	bar	bar	bar	gr/mt	mm	m
30	42	10	30	0,7	720	180	40
35	48	10	30	0,7	860	210	40
40	53	10	30	0,7	1020	240	40
45	59	10	30	0,7	1250	270	40
51	64	10	30	0,7	1650	306	40
60	74	10	30	0,7	2150	360	40
70	86	10	30	0,7	2620	420	40
80	96	10	30	0,7	3400	480	40
102	120	10	30	0,7	4900	600	40
127	147	10	30	0,7	7550	762	40
152	175	10	30	0,7	12100	912	40
203	228	10	30	0,7	18000	1218	40



**NORMAS** NORMS:  
EN 12115-TYPE SD  
**MARCADOR** MARKING:  
EUROCORD® CHIMICO SP W.P. 10 BAR  
**EMBALAJE** BOX:  
EMBALAJE EN POLIETILENO NEGRO  
PACKAGING IN BLACK POLYETHYLENE



**-40°C / +120°C**  
**-40°F / +248°F**

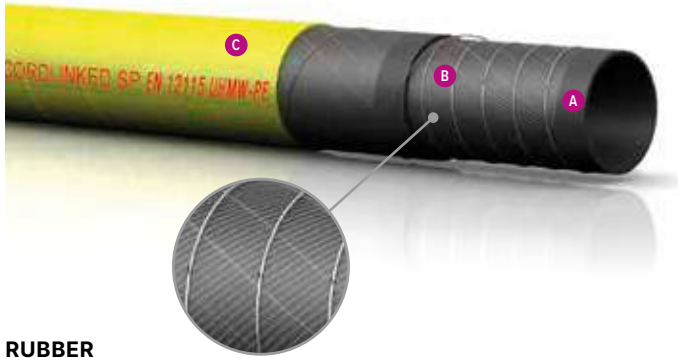

**RUBBER**



- **Apta para productos químicos corrosivos.**  
**Suitable for chemical corrosive products.**



**USO**  
**APPLICATIONS**

Adecuada para entrega y la aspiración de productos químicos corrosivos y especialmente para disolventes aromáticos.

For discharge of all corrosive chemicals, especially high aromatic solvents.



**ESTRUCTURA**  
**BODY**

<b>A</b> <b>Capa interior</b> Tube	En U.H.M.W.P.E. (Polietileno de peso molecular ultra alto) semitransparente, no tóxico, resistente a una amplia gama de productos químicos corrosivos y aprobada por F.D.A. Translucent, food grade UHMW-PE liner suitable for wide range of corrosive chemicals and solvents.
<b>B</b> <b>Refuerzos</b> Reinforcement	Tejidos en rayón de alta resistencia, 2 hilos de cobre para disipar la electricidad estática, espiral metálica. High tensile synthetic textile and antistatic copper wires.
<b>C</b> <b>Capa exterior</b> Cover	Caucho sintético amarillo resistente a los agentes atmosféricos, al ozono y a la abrasión. Weather, ozone, abrasion resistant EPDM rubber.
<b>Superficie</b> Surface	Lisa con impresión de tela. Smooth with fabric impression.



**ABRAZADERAS Y COLLARES DE APRIETE**  
**RECOMENDADOS**  
**RECOMMENDED CLAMP/COLLAR**

STC - Abrazaderas con perno Hose clamps with bolt (pag. 208-210)



mm	mm	bar	bar	bar	gr/mt	mm	m
19	31	10	40	0,7	510	190	40
25	37	10	40	0,7	710	250	40
30	42	10	40	0,7	820	300	40
32	44	10	40	0,7	870	320	40
35	47	10	40	0,7	930	350	40
38	52	10	40	0,7	1130	380	40
40	54	10	40	0,7	1300	400	40
45	59	10	40	0,7	1470	450	40
51	65	10	40	0,7	1600	510	40
60	75	10	40	0,7	1930	600	40
63,5	78,5	10	40	0,7	2180	635	40
70	86	10	40	0,7	2460	700	40
76	94	10	40	0,7	2960	760	40
80	98	10	40	0,7	3100	800	20-40
102	122	10	40	0,7	3250	1020	20-40



**NORMAS** NORMS:  
EN 12115 - TYPE SD  
**MARCADOR** MARKING:  
EUROCORD® CORDLINKED SP EN 12115 UHMW-PE  
**EMBALAJE** BOX:  
EMBALAJE EN POLIETILENO NEGRO  
PACKAGING IN BLACK POLYETHYLENE



**-40°C / +80°C**  
**-40°F / +176°F**



# MANGUERAS INDUSTRIALES PARA USO NAVAL Y EMBARCACIONES DE PUERTO

HOSES MARINE  
INDUSTRIAL HOSES





**RUBBER**



- **Extra flexible.**  
Extra flexible.
- **Homologado**  
Homologated



**USO APPLICATIONS**

Manguera adecuada para entrega de gasóleo y carburantes ecológicos en embarcaciones de recreo y barcos. Manguera extremadamente flexible y ligera con excelentes radios de curvatura.

Suitable for transfer diesel and fuel for marine craft. extra flexible.

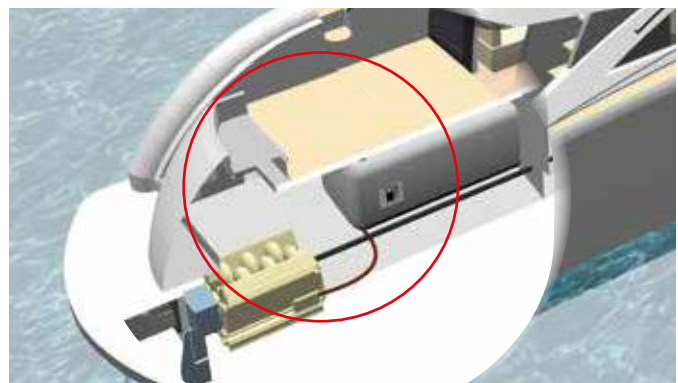

**ESTRUCTURA BODY**

<b>A</b> Capa interior Tube	Caucho negro liso resistente al carburante (NBR) con un contenido aromático no superior al 50%. NBR black oil/fuel rubber, smooth, resistant to maximum 50% aromatic contents.
<b>B</b> Refuerzos Reinforcement	Textiles, sintéticos de alta tenacidad. Synthetic textile.
<b>C</b> Capa exterior Cover	Mezcla en caucho sintético resistente a las llamas, los lubricantes, los carburantes, a la abrasión, el agua de mar y los agentes atmosféricos. Synthetic rubber compound, flame resistant, abrasion, ozone, weather, heat and oil resistant rubber.
Superficie Surface	Lisa. Smooth.

mm	mm	bar	bar	bar	gr/mt	mm	m
6	16	-	>14	-	0,240	60	40
8	17	-	>14	-	0,240	80	40
10	19	-	>14	-	0,280	100	40
12	22	-	>10	-	0,300	120	40
16	26	-	>10	-	0,460	160	40
19	30	-	>10	-	0,590	190	40



También disponible en bobinas.  
Also available in coils.

mm	mm	m
6	16	20
8	17	20
10	19	20

**ABRAZADERAS Y COLLARES DE APRIETE RECOMENDADOS**  
**RECOMMENDED CLAMP/COLLAR**

- STF - Abrazaderas de tornillo Hose clamps with screw (pag. 204-207)
- STM - Abrazaderas de apriete Hose clamps (pag. 213)
- SGT - Abrazaderas pinzables Stepp less (pag. 216)



**MARCADOR MARKING:**  
EUROCORD® EN ISO 7840:2013 A1 E E10/B10  
COMPATIBLE R.I.NA APPROVED - CE - YEAR - SAE J 1527:2011 USCG R1 - LLOYD'S APPROVED  
**EMBALAJE BOX:**  
EMBALAJE EN POLIETILENO AZUL  
PACKAGING IN BLUE POLYETHYLENE



**-35°C / +80°C**  
**+31°F / +176°F**

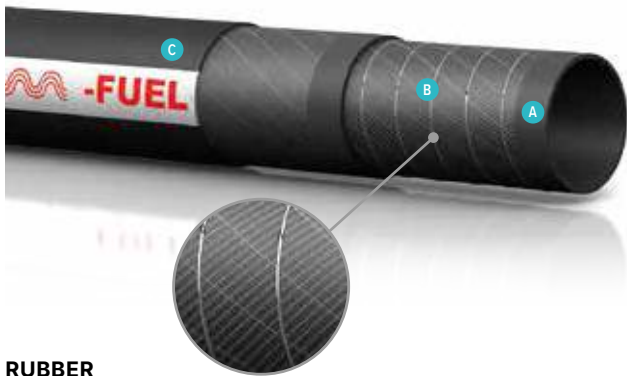

**RUBBER**



- **Flexible.**  
Flexible.
- **Bajo radio de curvatura.**  
Low bending radius.
- **Homologado**  
Homologated



**USO  
APPLICATIONS**

Adecuada para entrega y la aspiración de carburantes en embarcaciones de recreo y buques. Especialmente utilizada para aplicaciones de trabajo pesado. Se caracteriza por su ligereza y flexibilidad.

Suitable for delivery and suction of fuels on boats and in the light marine industry. Suitable for heavy duties. Flexibility and lightness are a characteristic of this hose.

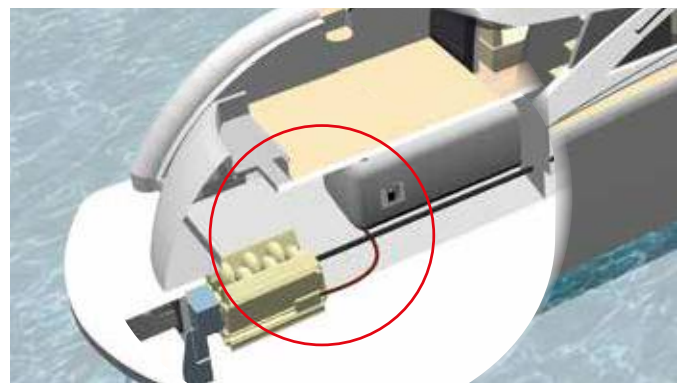

**ESTRUCTURA  
BODY**

<b>A</b>	<b>Capa interior Tube</b>	Caucho negro liso resistente al carburante (NBR) con un contenido aromático no superior al 50%. NBR black oil/fuel rubber, smooth, resistant to maximum 50% aromatic contents.
<b>B</b>	<b>Refuerzos Reinforcement</b>	Textiles, sintéticos de alta tenacidad y espiral metálica incorporada. Synthetic yarns fabrics and steel wire.
<b>C</b>	<b>Capa exterior Cover</b>	Mezcla en caucho sintético resistente a las llamas, los lubricantes, los carburantes, a la abrasión, el agua de mar y los agentes atmosféricos. Synthetic rubber compound, flame resistant, abrasion, ozone, weather, heat and oil resistant rubber.
	<b>Superficie Surface</b>	Lisa. Smooth.



**ABRAZADERAS Y COLLARES DE APRIETE  
RECOMENDADOS  
RECOMMENDED CLAMP/COLLAR**

- STF - Abrazaderas de tornillo Hose clamps with screw (pag. 204-207)
- STC - Abrazaderas con perno Hose clamps with bolt (pag. 208-210)
- BANDI BLOCK - Par de apriete Tightening torque (pag. 221)



mm	mm	bar	bar	bar	gr/mt	mm	m
19	31	2,5	10	-0,35	758	90	20
20	32	2,5	10	-0,35	787	100	20
22	34	2,5	10	-0,35	837	110	20
25	37	2,5	10	-0,35	918	125	20
30	42	2,5	10	-0,8	1.087	150	20
32	44	2,5	10	-0,8	1.148	160	20
35	47	2,5	10	-0,8	1.335	175	20
38	50	2,5	10	-0,8	1.433	190	20
40	52	2,5	10	-0,8	1.498	200	20
45	59	2,5	10	-0,8	1.954	223	20
51	63	2,5	10	-0,8	1.942	254	20
60	72	2,5	10	-0,8	2.226	300	20
63	76	2,5	10	-0,8	2.406	318	20



**MARCADOR MARKING:**  
EUROCORD® CARBOMARINE I.D. . EN ISO 7840:2013 A1 E E10/B10  
COMPATIBLE R.I.N.A APPROVED - CE - YEAR -  
~ - FUEL HOSE - SAE J 1527:2011 USCG A1 - LLOYD'S APPROVED

**EMBALAJE BOX:**  
EMBALAJE EN POLIETILENO AZUL  
PACKAGING IN BLUE POLYETHYLENE





**-20°C / +100°C**  
**+4°F / +212°F**





RUBBER



- **Extra flexible.**  
Extra flexible.
- **Bajo radio de curvatura.**  
Low bending radius.
- **Homologado**  
Homologated   **NMMA**
- **Versión corrugada más flexible.**  
More flexible corrugated version.

**USO APPLICATIONS**

Adecuada para entrega y la aspiración de carburantes en embarcaciones de recreo y buques. Especialmente utilizada para aplicaciones de trabajo pesado. Se caracteriza por su ligereza y flexibilidad.

Suitable for delivery and suction of fuels on boats and in the light marine industry. Suitable for heavy duties. Flexibility and lightness are a characteristic of this hose.

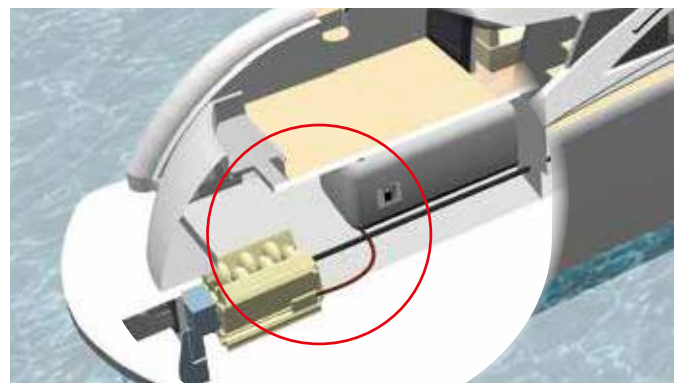

**ESTRUCTURA BODY**

<b>A</b> Capa interior Tube	Caucho negro liso resistente al carburante (NBR) con un contenido aromático no superior al 50%. NBR black oil/fuel rubber, smooth, resistant to maximum 50% aromatic contents.
<b>B</b> Refuerzos Reinforcement	Textiles, sintéticos de alta tenacidad y espiral metálica incorporada. Synthetic yarns fabrics and steel wire.
<b>C</b> Capa exterior Cover	Mezcla en caucho sintético resistente a las llamas, los lubricantes, los carburantes, a la abrasión, el agua de mar y los agentes atmosféricos. Synthetic rubber compound, flame resistant, abrasion, ozone, weather, heat and oil resistant rubber.
Superficie Surface	Lisa corrugada. Smooth corrugated.

 mm	 mm	 bar	 bar	 bar	 gr/mt	 mm	 m
19	26	5	15	-0,8	585	49	20
20	28	5	15	-0,8	616	52	20
22	31	5	15	-0,8	677	57	20
25	35	5	15	-0,8	770	65	20
30	40	5	15	-0,8	910	89	20
32	42	5	15	-0,8	970	95	20
35	46	5	15	-0,8	1096	105	20
38	50	5	15	-0,8	1190	115	20
40	52	5	15	-0,8	1252	129	20
45	59	5	15	-0,8	1409	145	20
51	61	5	15	-0,8	1540	165	20
60	72	5	15	-0,8	1811	194	20
63	76	5	15	-0,8	1902	203	20

**ABRAZADERAS Y COLLARES DE APRIETE RECOMENDADOS**  
**RECOMMENDED CLAMP/COLLAR**

- STF - Abrazaderas de tornillo Hose clamps with screw (pag. 204-207)
- STC - Abrazaderas con perno Hose clamps with bolt (pag. 208-210)
- BANDI BLOCK - Par de apriete Tightening torque (pag. 221)



**MARCADOR MARKING:**  
EUROCORD® CARBOMARINE I.D. . EN ISO 7840:2013 A1 E E10/B10  
COMPATIBLE R.I.NA APPROVED - CE - YEAR -  - FUEL HOSE - SAE J 1527:2011 USCG A1 - LLOYD'S APPROVED  
**EMBALAJE BOX:**  
EMBALAJE EN POLIETILENO AZUL  
PACKAGING IN BLUE POLYETHYLENE



**-20°C / +100°C**  
**+4°F / +212°F**





**RUBBER**



- **Estructura duradera.**  
Long life structure.
- **Homologado**  
Homologated



**USO  
APPLICATIONS**

Adecuada para la aspiración de gasóleo y carburantes ecológicos en embarcaciones de recreo y buques. Especialmente utilizada para aplicaciones de trabajo pesado. Se caracteriza por su ligereza y flexibilidad.

Suitable for transfer diesel and fuel for marine craft. Long Life structure.

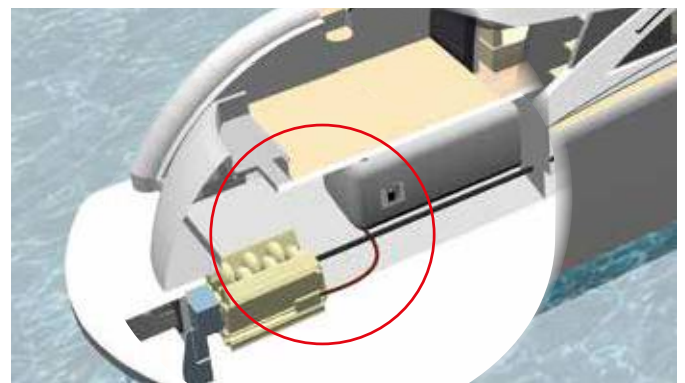

**ESTRUCTURA  
BODY**

<b>A</b>	<b>Capa interior Tube</b>	Caucho negro liso resistente al carburante (NBR) con un contenido aromático no superior al 50%. NBR black oil/fuel rubber, smooth, resistant to maximum 50% aromatic contents.
<b>B</b>	<b>Refuerzos Reinforcement</b>	Textiles, sintéticos de alta tenacidad. Synthetic textile.
<b>C</b>	<b>Capa exterior Cover</b>	Mezcla en caucho sintético resistente a las llamas, los lubricantes, los carburantes, a la abrasión, el agua de mar y los agentes atmosféricos. Synthetic rubber compound, flame resistant, abrasion, ozone, weather, heat and oil resistant rubber.
	<b>Superficie Surface</b>	Lisa. Smooth.



**ABRAZADERAS Y COLLARES DE APRIETE  
RECOMENDADOS  
RECOMMENDED CLAMP/COLLAR**

- STF - Abrazaderas de tornillo Hose clamps with screw (pag. 204-207)
- STC - Abrazaderas con perno Hose clamps with bolt (pag. 208-210)
- BANDI BLOCK - Par de apriete Tightening torque (pag. 221)



mm	mm	bar	bar	bar	gr/mt	mm	m
19	31	2,5	10	-	705	190	20
20	32	2,5	10	-	733	200	20
22	34	2,5	10	-	789	220	20
25	37	2,5	10	-	853	254	20
30	42	2,5	10	-	1.012	300	20
32	44	2,5	10	-	1.068	320	20
35	47	2,5	10	-	1.152	350	20
38	50	2,5	10	-	1.235	380	20
40	52	2,5	10	-	1.340	400	20
45	58	2,5	10	-	1.723	445	20
50	63	2,5	10	-	1.577	508	20
60	72	2,5	10	-	1.831	600	20
63	76	2,5	10	-	1.989	630	20



**MARCADOR MARKING:**  
EUROCORD® CARBOMARINE I.D. . EN ISO 7840:2013 A1 E E10/B10  
COMPATIBLE R.I.NA APPROVED - CE - YEAR -  
FUEL HOSE - SAE J 1527:2011 USCG A1 - LLOYD'S APPROVED

**EMBALAJE BOX:**  
EMBALAJE EN POLIETILENO AZUL  
PACKAGING IN BLUE POLYETHYLENE



**-20°C / +100°C**  
**+4°F / +212°F**

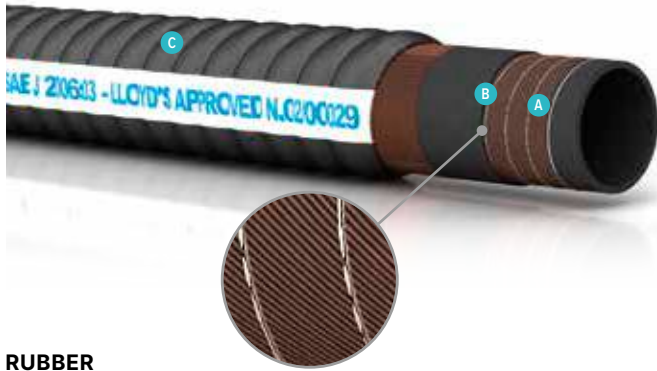

- **Superflexible.**  
Super flexible.
- **Radio de curvatura muy bajo.**  
Very low bending radius.
- **Homologado**  
Homologated



**RUBBER**

**USO APPLICATIONS**

Idóneo para la descarga de gases de combustión y de refrigeración de los intercambiadores de calor en barcos y embarcaciones de recreo. Gracias a su particular estructura resulta muy flexible y tiene unos excelentes radios de curvatura.

Suitable for discharging of exhaust gas, using at heating and cooling systems of craft. Very flexible.

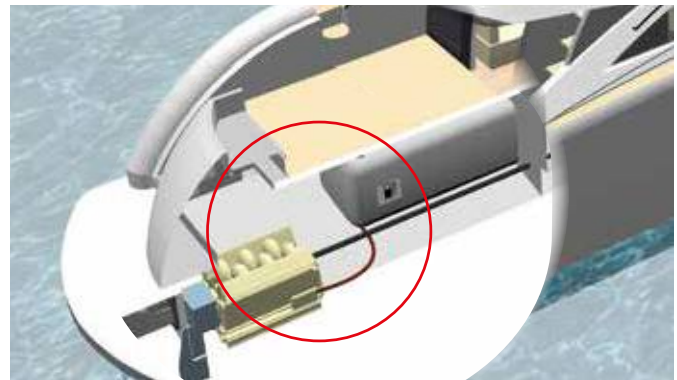

**ESTRUCTURA BODY**

<b>A</b>	<b>Capa interior Tube</b>	Caucho negro liso resistente a los gases de combustión y al agua de mar. Black, sea water and gas burning resistant rubber.
<b>B</b>	<b>Refuerzos Reinforcement</b>	2 Espirales metálicas incorporadas y refuerzos textiles, sintéticos de alta tenacidad. High tensile synthetic yarns and double steel helix wire.
<b>C</b>	<b>Capa exterior Cover</b>	Caucho negro resistente a la abrasión, al agua de mar y a los agentes atmosféricos. Black, abrasion, ozone, weather, heat and sea water.
	<b>Superficie Surface</b>	Corrugada con impresión de tela. Corrugated fabric finished.

mm	mm	bar	bar	bar	gr/mt	mm	m
20	-	3	9	0,3	336	80	20
25	-	3	9	0,3	473	100	20
30	-	3	9	0,3	573	120	20
32	-	3	9	0,3	633	130	10/20
35	-	3	9	0,3	657	140	20
38	-	3	9	0,3	707	150	10/20
40	-	3	9	0,3	741	160	10/20
45	-	3	9	0,3	884	180	10/20
51	-	3	9	0,3	999	200	10/20
55	-	3	9	0,3	1096	220	20
60	-	3	9	0,3	1189	240	10/20
63	-	3	9	0,3	1253	250	10/20
65	-	3	9	0,3	1281	260	20
70	-	3	9	0,3	1374	280	20
76	-	3	9	0,3	1719	300	10/20
80	-	3	9	0,3	1828	320	20
90	-	3	9	0,3	2046	360	10/20
100	-	3	9	0,3	2502	400	20
102	-	3	9	0,3	2540	400	10/20
110	-	3	9	0,3	2706	440	10/20
115	-	3	9	0,3	2800	460	10/20
120	-	3	9	0,3	2942	480	20
127	-	3	9	0,3	3107	500	10/20
130	-	3	9	0,3	3178	520	20
140	-	3	9	0,3	3860	570	20
152	-	3	9	0,3	4856	825	10/20
168	-	3	9	0,3	5450	925	20
180	-	3	9	0,3	5703	1000	10
203	-	3	9	0,3	6859	1200	10

**ABRAZADERAS Y COLLARES DE APRIETE RECOMENDADOS**  
**RECOMMENDED CLAMP/COLLAR**

- STF - Abrazaderas de tornillo Hose clamps with screw (pag. 204-207)
- STC - Abrazaderas con perno Hose clamps with bolt (pag. 208-210)
- BANDI BLOCK - Par de apriete Tightening torque (pag. 221)



**MARCADOR MARKING:**  
EUROCORD® MARINGAS/SP I.D. . R.I.NA APPROVED  
N. DIP042318XT/001 - ISO 13363:2006 - TYPE 1  
CLASS A & B - TYPE CLASS A & B

SAE J 2066:03 LLOYD'S APPROVED N. 02/0029

**EMBALAJE BOX:**  
EMBALAJE EN POLIETILENO AZUL  
PACKAGING IN BLUE POLYETHYLENE

**-30°C / +100°C**  
con picos de hasta  
with peaks up to  
+115°C

**-22°F / +212°F**  
con picos de hasta  
with peaks up to  
+239°F



**RUBBER**



**USO  
APPLICATIONS**

Manguera adecuada para el paso del agua de refrigeración y los gases de combustión de los motores de explosión de barcos y embarcaciones de recreo.

Used as marine engine intake and wet exhaust hose in boats and ships.



- **Resistente a temperaturas muy altas.**  
Resistant to very high temperature.
- **Radio de curvatura muy bajo.**  
Very low bending radius.

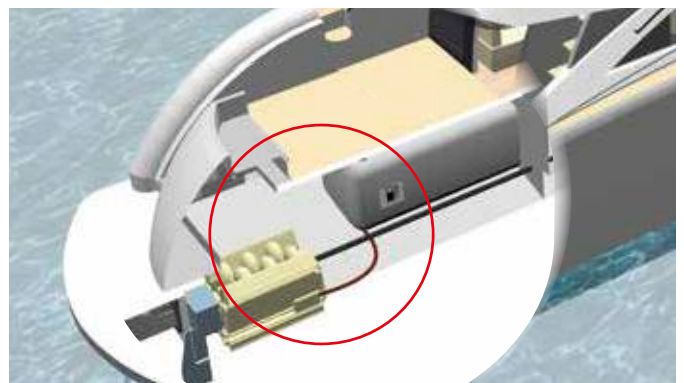

**ESTRUCTURA  
BODY**

<b>A</b>	<b>Capa interior Tube</b>	Caucho de silicona azul liso, resistente al calor y al agua de mar. Smooth, blue silicone rubber, heat and salt water resistant.
<b>B</b>	<b>Refuerzos Reinforcement</b>	Textiles, resistentes a las altas temperaturas, 2 espirales de acero incorporadas entre los tejidos.i. High temperature resistant plies, 2 steel wire spirals.
<b>C</b>	<b>Capa exterior Cover</b>	Caucho de silicona azul corrugado, resistente al calor y a los agentes atmosféricos. Smooth, blue silicone rubber, heat and salt water resistant.

mm	mm	bar	bar	bar	gr/mt	mm	m
19	-	-	25	-	0,43	90	20
20	-	-	25	-	0,45	95	20
25	-	-	20	-	0,54	100	20
28	-	-	20	-	0,59	105	20
30	-	-	18	-	0,63	110	20
32	-	-	18	-	0,66	115	20
35	-	-	15	-	0,72	125	20
38	-	-	15	-	0,88	130	20
40	-	-	15	-	0,97	135	20
42	-	-	15	-	1,02	135	20
45	-	-	12	-	1,08	140	20
48	-	-	12	-	1,14	150	20
51	-	-	12	-	1,20	160	20
54	-	-	10	-	1,27	160	20
60	-	-	8	-	1,39	165	20
63,5	-	-	8	-	1,59	170	20
65	-	-	8	-	1,62	170	20
67	-	-	8	-	1,67	175	20
70	-	-	8	-	1,74	180	20
73	-	-	8	-	1,88	200	20
76	-	-	8	-	1,94	220	20
80	-	-	8	-	2,04	225	20
90	-	-	7	-	3,26	250	20
102	-	-	6	-	3,65	280	20
114	-	-	6	-	4,04	290	20
127	-	-	6	-	4,46	300	20
133	-	-	6	-	4,93	350	20
140	-	-	6	-	5,74	360	20
152	-	-	6	-	6,19	400	20
203	-	-	5	-	10,29	450	10
254	-	-	5	-	14,92	1200	10
305	-	-	5	-	18,69	1450	10
350	-	-	5	-	21,58	1750	6
404	-	-	4	-	26,72	2000	6



**MARCADOR MARKING:**  
EUROCORD® SILMARINE/SP MARINE EXHAUST SAE J2006 R2



**-60°C / +200°C**  
**-76°F / +392°F**

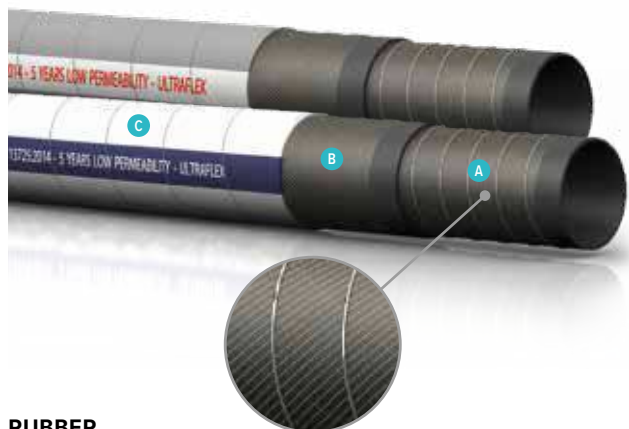

**RUBBER**



- **Gran resistencia a los olores.**  
Very strong odorless.
- **Fuerte permeabilidad.**  
Strong permeability.
- **De larga duración.**  
Long life.

**USO APPLICATIONS**

Manguera adecuada para la descarga de agua y líquidos orgánicos en el interior de las embarcaciones de recreo. Su estructura extremadamente flexible le permite tener excelentes radios de curvatura. Por tanto, es adecuada para espacios reducidos y de paso difícil.

Suitable for craft marine toilets. The special inner avoid the spreading of bad odours from the toilet drain. It's extremely flexible for guarantee special bending radius inside the structure of the craft. Suitable for narrow spaces.

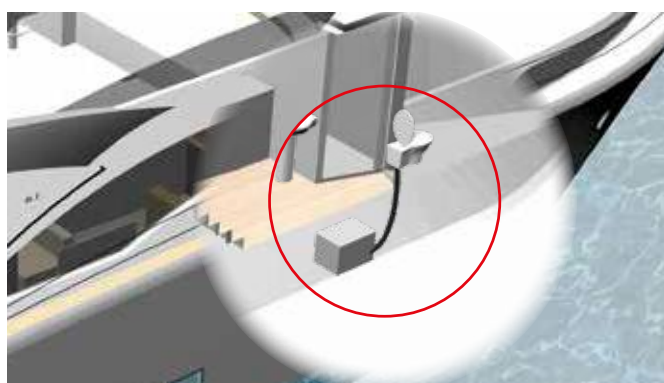

**ESTRUCTURA BODY**

<b>A</b>	<b>Capa interior Tube</b>	Caucho butílico negro. Black, butyl rubber.
<b>B</b>	<b>Refuerzos Reinforcement</b>	Textiles, sintéticos de alta tenacidad y espiral metálica incorporada. Synthetic textile fabrics and steel wire.
<b>C</b>	<b>Capa exterior Cover</b>	En caucho EPDM gris o blanco resistente a los agentes atmosféricos, al envejecimiento y al ozono. Gray or white EPDM, abrasion, ozone, weather, resistant rubber.

16	24	-	-	0,8	345	50	40/30
19	27	-	-	0,8	410	60	40/30
25,4	33	-	-	0,8	525	80	40/30
30	38	-	-	0,8	605	95	40/30
38	46,5	-	-	0,8	930	120	40/30
40	48,5	-	-	0,8	975	130	40/30
51	59	-	-	0,8	1215	175	40/30

**ABRAZADERAS Y COLLARES DE APRIETE RECOMENDADOS**  
**RECOMMENDED CLAMP/COLLAR**

- STF - Abrazaderas de tornillo Hose clamps with screw (pag. 204-207)
- STC - Abrazaderas con perno Hose clamps with bolt (pag. 208-210)



**MARCADOR MARKING:**  
EUROCORD® SANITARI WC TESTED ISO 8099:2000 & UNI EN 13725:2014 - 5 YEARS LOW PERMEABILITY - ULTRAFLEX

**EMBALAJE BOX:**  
EMBALAJE EN POLIETILENO TRANSPARENTE  
PACKAGING IN TRANSPARENT POLYETHYLENE

**-40°C / +120°C**  
**-40°F / +248°F**



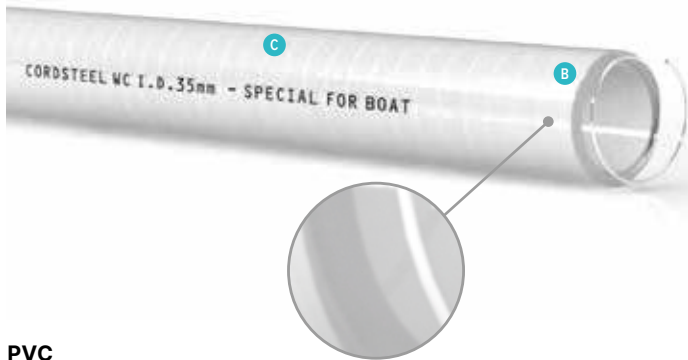

- **Extremadamente flexible.**  
Extremely flexible.

PVC



**USO  
APPLICATIONS**

Manguera adecuada para la descarga de agua y líquidos orgánicos en el interior de las embarcaciones de recreo. Su estructura extremadamente flexible le permite tener excelentes radios de curvatura. Por tanto, es adecuada para espacios reducidos y de paso difícil.

Suitable for craft marine toilets. The special inner avoid the spreading of bad odours from the toilet drain. It is extremely flexible for guarantee special bending radius inside the structure of the boat. Suitable for narrow spaces.

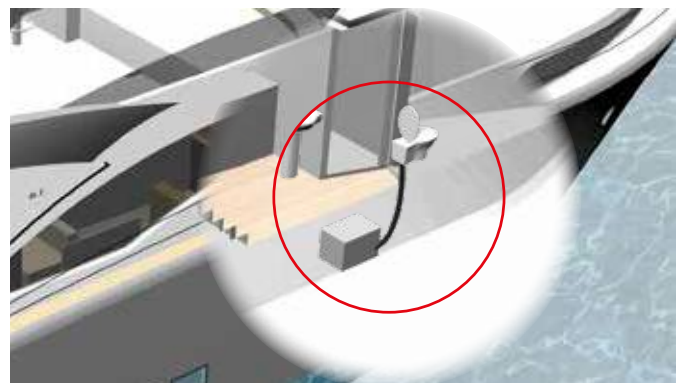

**ESTRUCTURA  
BODY**

**B** Refuerzos Reinforcement Espiral metálica incorporada. Built in steel spiral.

**C** Capa exterior Cover Blanco. White.

mm	mm	bar	bar	bar	gr/mt	mm	m
12	3,0	7	-	0,85	180	25	30/60
14	3,0	6	-	0,85	200	30	30/60
16	3,1	6	-	0,85	225	35	30/60
18	3,1	6	-	0,85	280	40	30/60
20	3,1	5	-	0,85	340	50	30/60
22	3,2	5	-	0,85	370	55	30/60
25	3,2	5	-	0,85	510	60	30/60
30	3,5	4	-	0,85	600	70	30/60
32	3,9	4	-	0,85	650	75	30
35	4,2	4	-	0,85	730	80	30
38	4,4	4	-	0,85	800	90	30
40	4,5	3	-	0,85	870	95	30
45	5,1	3	-	0,80	1100	105	30
50	5,1	3	-	0,80	1200	125	30
60	6,5	2,5	-	0,70	1800	135	30
63	6,5	2,5	-	0,70	1950	150	30
70	7	2	-	0,70	2200	180	30
76	7	2	-	0,70	2500	195	30
80	7,5	2	-	0,70	2700	220	30
90	7,5	2	-	0,60	3000	260	30
102	8	2	-	0,60	3400	300	30



**ABRAZADERAS Y COLLARES DE APRIETE  
RECOMENDADOS  
RECOMMENDED CLAMP/COLLAR**

- STF - Abrazaderas de tornillo Hose clamps with screw (pag. 204-207)
- STC - Abrazaderas con perno Hose clamps with bolt (pag. 208-210)



**MARCADOR MARKING:**  
CORDSTEEL WC I.D MM - SPECIAL FOR BOAT  
**EMBALAJE BOX:**  
EMBALAJE DE POLIETILENO BLANCO  
PACKAGING IN WHITE POLYETHYLENE



**-5°C / +60°C**  
**+23°F / +140°F**

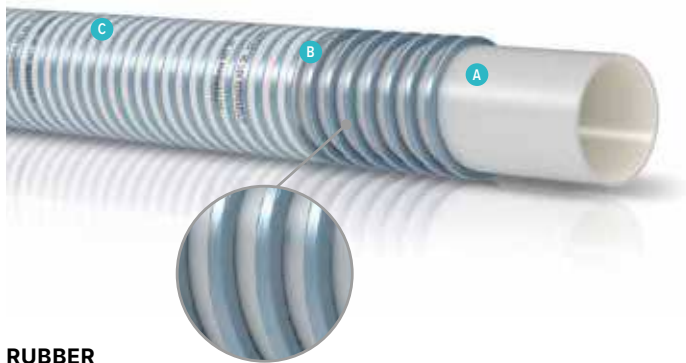

**RUBBER**



- **Nueva generación de mangueras inodoras.**  
New generation of odorless hoses.
- **Refuerzo con espiral en PVC.**  
PVC spiral reinforcement.

**USO APPLICATIONS**

Especialmente diseñada como manguera de desagüe de aguas negras en los aseos de embarcaciones, caravanas, etc. Gracias al material especial del que está fabricada, es una alternativa viable a la manguera en caucho, con las siguientes ventajas: mayor flexibilidad y ligereza y mayor rentabilidad, máxima impermeabilidad a los olores.

The low odour permeability of Saniflex delivery hose makes it ideal for conveying products where odour is a problem; i.e. toilet hoses on boats, trailers, caravans. Advantages compared to standard rubber hoses: more economical; higher odour-resistant; lighter and extra flexible.

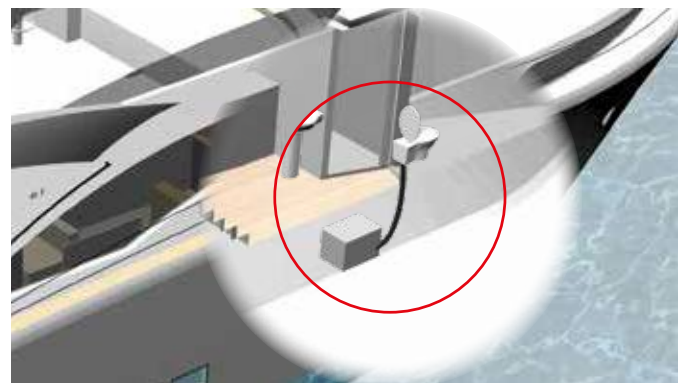

**ESTRUCTURA BODY**

<b>A</b> <b>Mescola interna</b> Internal composition	Mezcla especial en PVC que impide la propagación de los malos olores. Special PVC compound that prevents bad odours.
<b>B</b> <b>Refuerzos</b> Reinforcement	PVC antichoque. Hard PVC antishock.
<b>C</b> <b>Capa exterior</b> Cover	Resistente al deterioro causado por el ozono y los rayos UV. Resistant to ozone and UV caused damages the outer material is slightly UV stabilised.

mm	mm	bar	bar	bar	gr/mt	mm	m
16	22,5	7	17	0,7	260	64	25
20	27	6	15	0,7	340	80	25
25	33	6	15	0,6	445	100	25
30	38	6	15	0,6	560	120	25
35	43,6	6	15	0,55	693	140	25
38	46	6	15	0,55	790	150	25
40	49	5	12	0,5	875	160	25
50	58	4	10	0,4	1100	250	25
60	68,4	3	8	0,35	1350	300	25

**ABRAZADERAS Y COLLARES DE APRIETE RECOMENDADOS**  
**RECOMMENDED CLAMP/COLLAR**

- STF - Abrazaderas de tornillo Hose clamps with screw (pag. 204-207)
- STC - Abrazaderas con perno Hose clamps with bolt (pag. 208-210)



**MARCADOR MARKING:**  
SANIFLEX WC LOW PERMEABILITY

**EMBALAJE BOX:**  
EMBALAJE DE POLIETILENO BLANCO  
PACKAGING IN WHITE POLYETHYLENE

**-15°C / +65°C**  
**+5°F / +149°F**

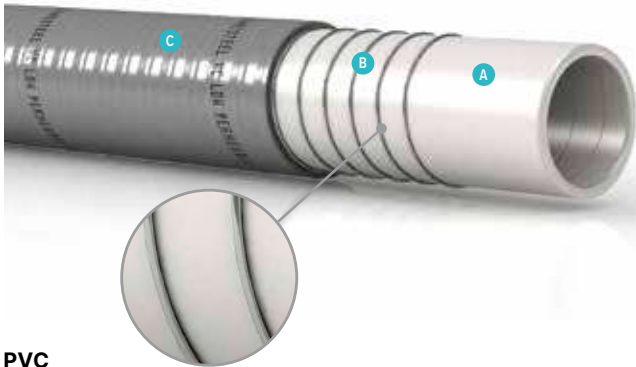

PVC



- Nueva generación de mangueras inodoras.  
New generation of odorless hoses.
- Refuerzo de alambre de acero.  
Steel wire reinforcement.



**USO  
APPLICATIONS**

Especialmente diseñada como manguera de desagüe de aguas negras en los aseos de embarcaciones, caravanas, etc. Gracias al material especial del que está fabricada, es una alternativa viable a la manguera en caucho, con las siguientes ventajas: mayor flexibilidad y ligereza y mayor rentabilidad, máxima impermeabilidad a los olores.

The low odour permeability of Sanisteel delivery hose makes it ideal for conveyor products where odour is a problem; i.e. toilet hoses on boats, trailers, caravans. Advantages compared to standard rubber hoses: more economical; higher odour-resistant; lighter and extra flexible.

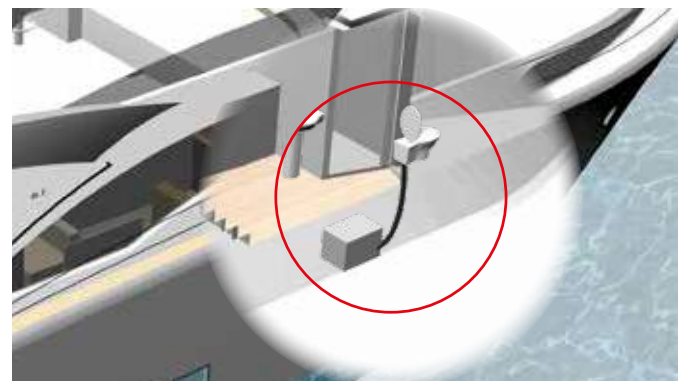

**ESTRUCTURA  
BODY**

<b>A</b> <b>Mescola interna</b> Internal composition	Mezcla especial en PVC que impide la propagación de los malos olores. Special PVC compound that prevents bad odours.
<b>B</b> <b>Refuerzos</b> Reinforcement	De acero antichoque y ultraflexible. Steel wire ultra-flexible.
<b>C</b> <b>Capa exterior</b> Cover	Resistente al deterioro causado por el ozono y los rayos UV. Resistant to ozone and UV caused damages the outer material is slightly UV stabilised.

mm	mm	bar	bar	bar	gr/mt	mm	m
20	27	8,5	24	0,9	340	30	25
25	33	8,5	24	0,9	520	38	25
30	38,4	8	24	0,9	630	60	25
38	47	8	24	0,9	800	76	25
40	50	8	24	0,9	950	80	25
50	60	8	24	0,9	1020	100	25



**ABRAZADERAS Y COLLARES DE APRIETE  
RECOMENDADOS  
RECOMMENDED CLAMP/COLLAR**

STF - Abrazaderas de tornillo Hose clamps with screw (pag. 204-207)  
STC - Abrazaderas con perno Hose clamps with bolt (pag. 208-210)



**MARCADOR MARKING:**  
SANISTEEL WC LOW PERMEABILITY  
**EMBALAJE BOX:**  
EMBALAJE DE POLIETILENO BLANCO  
PACKAGING IN WHITE POLYETHYLENE



**-5°C / +60°C**  
**+23°F / +140°F**

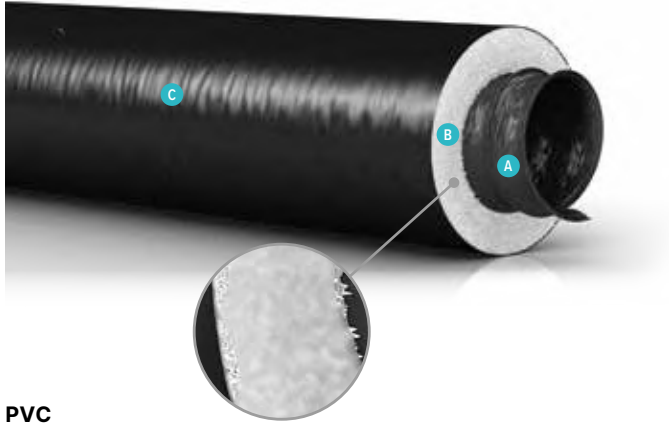

PVC

- Muy flexible.**  
**Very flexible.**

**USO APPLICATIONS**

Ventilación mecánica de flujo simple y doble. Reducción de la condensación y las dispersiones de calor. Se utiliza para el aire acondicionado. Adecuado en los sectores industrial y naval.

Air conditioning. Single and double-flow mechanical ventilation. Suitable for air conditioning. It is used in marine and industrial sectors.

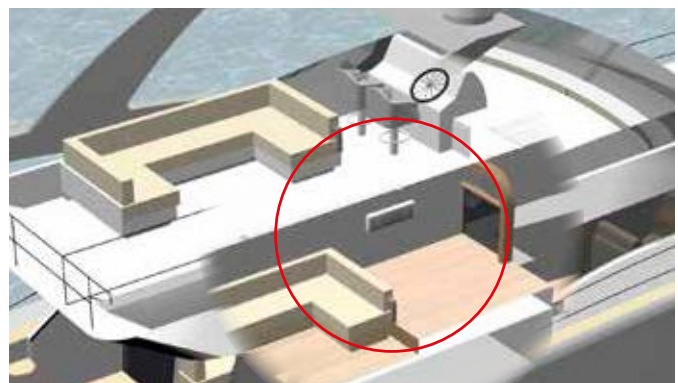

**ESTRUCTURA BODY**

<b>A</b>	<b>Capa interior Tube</b>	Resinas poliolefinicas aditivadas. Addivated polyolefin resin film.
<b>B</b>	<b>Refuerzos Reinforcement</b>	Espiral de alambre de acero armónico. Steel wire helix.
<b>C</b>	<b>Capa exterior Cover</b>	Revestimiento de aislamiento térmico en fibra de poliéster (25 mm de espesor 16 kg/m³). Protección exterior impermeable al vapor de resina de poliolefina aditivada y revestimiento en fibra de poliéster termoaislante. Outer anti-steam protection in addivated polyolefin resin. Thermo-insulating covering in polyester fibre (thickness 25 mm - 16 kg/m³).

mm	VELOCIDAD DEL AIRE 8 mt/sec.		VELOCIDAD DEL AIRE 10 mt/sec.		m
	CAUDAL DE AIRE m³/h	PÉRDIDA DE CARGA in Pa	CAUDAL DE AIRE m³/h	PÉRDIDA DE CARGA in Pa	
80	152	1-	190	31	10
102	250	15	333	24	10
127	383	12	368	18	10
160	575	8	773	14	10
203	900	6,5	1151	10,5	10
254	1445	4,7	1843	7,5	10
318	2278	3,7	3105	6	10
356	3058	3	3850	5,2	10
406	3845	2,7	4590	4,4	10
508	5111	2	8223	3	10

Ejemplos de cálculo de caudales y pérdidas de carga. Example of calculation of flow rates and pressure drop.

Para calcular los caudales y pérdidas de carga para otros diámetros, solicite nuestro diagrama de pérdidas de carga.

To calculate the flow and pressure drop of the other diameter, request our pressure drop diagram.

**REACCIÓN AL FUEGO:**  
CLASE 1 - M1

**FIRE REACTION:**  
CLASS 1 - M1

**-20°C / +90°C**  
con picos de hasta with peaks up to +110°C

**-4°F / +194°F**  
con picos de hasta with peaks up to +230°F



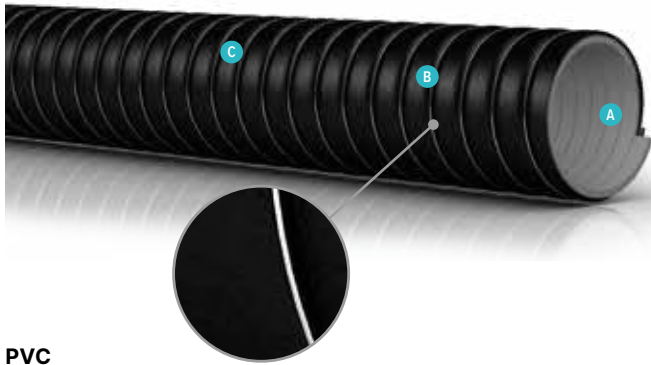

PVC



**USO  
APPLICATIONS**

Se utiliza en aire acondicionado, ventilación mecánica de flujo simple y doble, reducción de condensados y pérdidas de calor, sistemas de aire acondicionado para aplicaciones de transporte, agricultura, industria y construcción naval.

Air conditioning, Mechanical ventilation simple or double flow, Reduction of condensation and heat dispersion, air conditioning plants for transport, agricultural, industrial and marine use.



**ESTRUCTURA  
BODY**

<b>A</b>	<b>Capa interior Tube</b>	Resinas poliolefinicas aditivadas. Addivated polyolefin resin film.
<b>B</b>	<b>Refuerzos Reinforcement</b>	Espiral de alambre de acero armónico. Steel wire helix.
<b>C</b>	<b>Capa exterior Cover</b>	Revestimiento termoaislante en espuma de polietileno reticulado de célula cerrada, película de protección exterior de resinas poliolefinicas aditivadas. Flexible hose made of addivated polyolefin resins film, thermos - insulating coating in netted and closed cell foam polyethylene, external protection in addivated polyolefin resins film and embedded steel wire helix.

mm	mm	bar	bar	bar	gr/mt	mm	m
50	-	-	0,70	0,18	96	35	10
60	-	-	0,70	0,15	115	42	10
70	-	-	0,60	0,13	128	49	10
80	-	-	0,50	0,09	154	56	10
102	-	-	0,40	0,08	200	70	10
127	-	-	0,40	0,07	254	92	10
152	-	-	0,20	0,05	308	105	10
160	-	-	0,15	0,05	331	110	10
180	-	-	0,15	0,05	438	130	10
203	-	-	0,15	0,04	492	140	10
254	-	-	0,08	0,03	600	175	10

\*Pressure and vacuum data based on +20° room temperature.



- **Muy flexible.**  
Very flexible.
- **Poco ruido.**  
Low noise.

**ESPUMA DE POLIETILENO RETICULADO TIPO CL1 NETTED  
NETTED POLYETHYLENE FOAM TYPE CL1**

PROPIEDADES FÍSICO-MECÁNICAS Physical-mechanical properties	U.M. S.M.	METODO Rules	VALORI Values
DENSIDAD Density	kg/m³	CSE RF 2/75° RF 3/77	30
CLASE DE COMBUSTIÓN Class of combustion		UNI 7745 ASTM C177 UNI7745 ASRM C177	CL1
COEFICIENTE DE CONDUCTIVIDAD TÉRMICA A 0°C (λ) Coefficient of thermal conductivity at 0°C (λ)	W/mk kcal/min °C	UNI 7745 ASTM C177 UNI7745 ASRM C177	0,0344 0,0294
COEFICIENTE DE CONDUCTIVIDAD TÉRMICA A 40°C (λ) Coefficient of thermal conductivity at 40°C (λ)	W/mk kcal/min °C	DIN 52615	0,0372 0,032
COEF. ALTA RESISTENCIA A LA DIFUSIÓN DEL VAPOR DE AGUA Coefficient of resistance to water steam diffusion	μ	DIN 52616	>65.000
PERMEABILIDAD AL VAPOR DE AGUA Permeability to water steam	Ng/Pa s m	DIN 53433	0,12
ABSORCIÓN DE AGUA DESPUÉS DE 24 DÍAS Water absorbtion after 24 days	Vol. %	ISO 3386/1	<3
RESISTENCIA A LA COMPRESIÓN AL 10% Compressive strenght at 10%	g/cm²	DIN53431	190,00
ESTABILIDAD DIMENSIONAL Dimension stability	°C		100
TEMPERATURA MÁXIMA DE USO Max operating temperature	°C		-80 +100
TEMPERATURA DE USO CON ESFUERZO MECÁNICO Operating temperature with mechanical stress	°C		-40 +100



**REACCIÓN AL FUEGO:**  
PELÍCULA INTERIOR Y EXTERIOR CLASE 1 - M1,  
ESPUMA DE PES CLASE 1 - M1  
**FIRE REACTION:**  
INTERNAL AND EXTERNAL FILM CLASS 1 - M1, PES  
CLOSED-CELL FOAM 1 - M1



**-40°C / +100°C**  
**-40°F / +212°F**

**SATIBLOCK®**

**ABRAZADERAS  
Y COLLARES DE APRIETE**

CLAMPS AND COLLAR

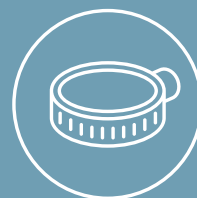

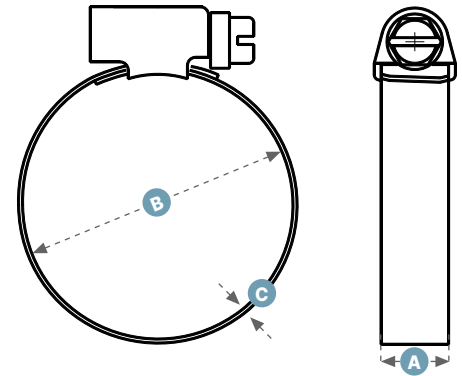

**USO  
APPLICATIONS**

Industria en general	Industry in general
Maquinaria agrícola	Agriculture machine
Construcción	Construction
Riego	Irrigation



**DESCRIPCIÓN  
DESCRIPTION**

Abrazadera de alta estanqueidad, compacta y resistente. La banda interior lisa y los bordes elevados confieren a la manguera una seguridad absoluta. Conforme con la normativa DIN 3017.

High resistant clamp, compact and durable. Rolle-up band edges and smooth band underside are able to guarantee total protection to the hose. Conforme to DIN 3017.



**MATERIAL  
MATERIAL**

<b>Banda Band</b>	Acero inoxidable Stainless steel <b>AISI 201</b>
<b>Cajón Housing</b>	Acero galvanizado Zinc-plated steel
<b>Tornillo Screw</b>	Acero galvanizado Zinc-plated steel

ANCH. CINTA BAND WIDTH	DIAM. DIAM.	ESPESOR THICKNESS	PAR DE APRIETE RECOMENDADO RECOMMENDED TIGHTENING TORQUE (PAG. 221)	CAJAS BOX
<b>A</b>	<b>B</b>	<b>C</b>	<b>Nm</b>	<b>pz/nrm</b>
mm	mm	mm		

**9  
mm**

W1A09008012000	9	8-12	0,8	2,6	100
W1A09010016000	9	10-16	0,8	2,6	100
W1A09012020000	9	12-20	0,8	2,6	100
W1A09016025000	9	16-25	0,8	4,0	100
W1A09016027000	9	16-27	0,8	4,0	100
W1A09020032000	9	20-32	0,8	4,0	100
W1A09025040000	9	25-40	0,8	4,0	100
W1A09035050000	9	32-50	0,8	4,0	50
W1A09040060000	9	40-60	0,8	4,0	50
W1A09050070000	9	50-70	0,8	4,0	50
W1A09060080000	9	60-80	0,8	4,0	50
W1A09070090000	9	70-90	0,8	4,0	25
W1A09080100000	9	80-100	0,8	4,0	25
W1A09090110000	9	90-110	0,8	4,0	25
W1A09100120000	9	100-120	0,8	4,0	25
W1A09110130000	9	110-130	0,8	4,0	25
W1A09120140000	9	120-140	0,8	4,0	25
W1A09130150000	9	130-150	0,8	4,0	25

**12  
mm**

W1B12016025000	12	16-25	1,0	6,5	100
W1B12016027000	12	16-27	1,0	6,5	100
W1B12020032000	12	20-32	1,0	6,5	100
W1B12025040000	12	25-40	1,0	6,5	100
W1B12035050000	12	32-50	1,0	6,5	50
W1B12040060000	12	40-60	1,0	6,5	50
W1B12050070000	12	50-70	1,0	6,5	50
W1B12060080000	12	60-80	1,0	6,5	50
W1B12070090000	12	70-90	1,0	6,5	25
W1B12080100000	12	80-100	1,0	6,5	25
W1B12090110000	12	90-110	1,0	6,5	25
W1B12100120000	12	100-120	1,0	6,5	25
W1B12110130000	12	110-130	1,0	6,5	25
W1B12120140000	12	120-140	1,0	6,5	25
W1B12130150000	12	130-150	1,0	6,5	25
W1B12140160000	12	140-160	1,0	6,5	25
W1B12150170000	12	150-170	1,0	6,5	25
W1B12160180000	12	160-180	1,0	6,5	25
W1B12170190000	12	170-190	1,0	6,5	25
W1B12180200000	12	180-200	1,0	6,5	25

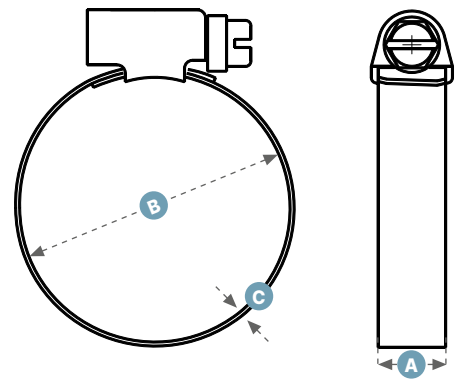

**USO**  
**APPLICATIONS**

Maquinaria agrícola	Agriculture machine
Construcción	Construction
Riego	Irrigation
Automoción	Automotive

**DESCRIPCIÓN**  
**DESCRIPTION**

Abrazadera de alta estanqueidad, compacta y resistente. La banda interior lisa y los bordes elevados confieren a la manguera una seguridad absoluta. Conforme con la normativa DIN 3017.

High resistant clamp, compact and durable. Rolle-up band edges and smooth band underside are able to guarantee total protection to the hose. Conforme to DIN 3017.

**MATERIAL**  
**MATERIAL**

<b>Banda</b> Band	Acero inoxidable Stainless steel <b>AISI 430</b>
<b>Cajón</b> Housing	Acero inoxidable Stainless steel <b>AISI 430</b>
<b>Tornillo</b> Screw	Acero galvanizado Zinc-plated steel

		ANCH. CINTA BAND WIDTH	DIÁM. DIAM.	ESPESOR THICKNESS	PAR DE APRIETE RECOMENDADO TORQUE (PAG. 221)	CAJAS BOX
		<b>A</b> mm	<b>B</b> mm	<b>C</b> mm	<b>Nm</b>	<b>pz/nrm</b>
<b>9</b> mm	W2A09008012000	9	8-12	0,8	2,6	100
	W2A09010016000	9	10-16	0,8	2,6	100
	W2A09012020000	9	12-20	0,8	2,6	100
	W2A09016025000	9	16-25	0,8	4,0	100
	W2A09016027000	9	16-27	0,8	4,0	100
	W2A09020032000	9	20-32	0,8	4,0	100
	W2A09025040000	9	25-40	0,8	4,0	100
	W2A09035050000	9	32-50	0,8	4,0	50
	W2A09040060000	9	40-60	0,8	4,0	50
	W2A09050070000	9	50-70	0,8	4,0	50
	W2A09060080000	9	60-80	0,8	4,0	50
	W2A09070090000	9	70-90	0,8	4,0	25
	W2A09080100000	9	80-100	0,8	4,0	25
	W2A09090110000	9	90-110	0,8	4,0	25
	W2A09100120000	9	100-120	0,8	4,0	25
	W2A09110130000	9	110-130	0,8	4,0	25
W2A09120140000	9	120-140	0,8	4,0	25	
W2A09130150000	9	130-150	0,8	4,0	25	
<b>12</b> mm	W2B12012020000	12	12-20	1,0	6,5	100
	W2B12016025000	12	16-25	1,0	6,5	100
	W2B12016027000	12	16-27	1,0	6,5	100
	W2B12020032000	12	20-32	1,0	6,5	100
	W2B12025040000	12	25-40	1,0	6,5	100
	W2B12035050000	12	32-50	1,0	6,5	50
	W2B12040060000	12	40-60	1,0	6,5	50
	W2B12050070000	12	50-70	1,0	6,5	50
	W2B12060080000	12	60-80	1,0	6,5	50
	W2B12070090000	12	70-90	1,0	6,5	25
	W2B12080100000	12	80-100	1,0	6,5	25
	W2B12090110000	12	90-110	1,0	6,5	25
	W2B12100120000	12	100-120	1,0	6,5	25
	W2B12110130000	12	110-130	1,0	6,5	25
	W2B12120140000	12	120-140	1,0	6,5	25
	W2B12130150000	12	130-150	1,0	6,5	25
W2B12140160000	12	140-160	1,0	6,5	25	
W2B12150170000	12	150-170	1,0	6,5	25	
W2B12160180000	12	160-180	1,0	6,5	25	
W2B12170190000	12	170-190	1,0	6,5	25	
W2B12180200000	12	180-200	1,0	6,5	25	



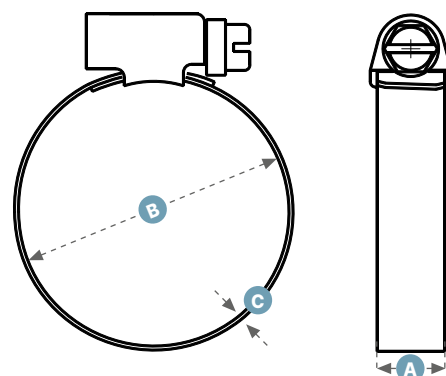

## USO APPLICATIONS

Náutica Marine  
Alimentación Food



## DESCRIPCIÓN DESCRIPTION

Abrazadera de alta estanqueidad, compacta y resistente. La banda interior lisa y los bordes elevados confieren a la manguera una seguridad absoluta. Conforme con la normativa DIN 3017.

High resistant clamp, compact and durable. Rolle-up band edges and smooth band underside are able to guarantee total protection to the hose. Conforme to DIN 3017.



## MATERIAL MATERIAL

Banda Band	Acero inoxidable Stainless steel <b>AISI 304</b>
Cajón Housing	Acero inoxidable Stainless steel <b>AISI 304</b>
Tornillo Screw	Acero inoxidable Stainless steel <b>AISI 304</b>

ANCH. CINTA BAND WIDTH	DIAM. DIAM.	ESPESOR THICKNESS	PAR DE APRIETE RECOMMENDED TIGHTENING TORQUE (PAG. 221)	CAJAS BOX
A	B	C	Nm	pz/nrm

**9**  
mm

W4A09008012000	9	8-12	0,8	2,6	100
W4A09010016000	9	10-16	0,8	2,6	100
W4A09012020000	9	12-20	0,8	2,6	100
W4A09016025000	9	16-25	0,8	4,0	100
W4A09016027000	9	16-27	0,8	4,0	100
W4A09020032000	9	20-32	0,8	4,0	100
W4A09025040000	9	25-40	0,8	4,0	100
W4A09035050000	9	32-50	0,8	4,0	50
W4A09040060000	9	40-60	0,8	4,0	50
W4A09050070000	9	50-70	0,8	4,0	50
W4A09060080000	9	60-80	0,8	4,0	50
W4A09070090000	9	70-90	0,8	4,0	25
W4A09080100000	9	80-100	0,8	4,0	25
W4A09090110000	9	90-110	0,8	4,0	25
W4A09100120000	9	100-120	0,8	4,0	25
W4A09110130000	9	110-130	0,8	4,0	25
W4A09120140000	9	120-140	0,8	4,0	25
W4A09130150000	9	130-150	0,8	4,0	25

**12**  
mm

W4B12012020000	12	12-20	1,0	6,5	100
W4B12016025000	12	16-25	1,0	6,5	100
W4B12016027000	12	16-27	1,0	6,5	100
W4B12020032000	12	20-32	1,0	6,5	100
W4B12025040000	12	25-40	1,0	6,5	100
W4B12035050000	12	32-50	1,0	6,5	50
W4B12040060000	12	40-60	1,0	6,5	50
W4B12050070000	12	50-70	1,0	6,5	50
W4B12060080000	12	60-80	1,0	6,5	50
W4B12070090000	12	70-90	1,0	6,5	25
W4B12080100000	12	80-100	1,0	6,5	25
W4B12090110000	12	90-110	1,0	6,5	25
W4B12100120000	12	100-120	1,0	6,5	25
W4B12110130000	12	110-130	1,0	6,5	25
W4B12120140000	12	120-140	1,0	6,5	25
W4B12130150000	12	130-150	1,0	6,5	25
W4B12140160000	12	140-160	1,0	6,5	25
W4B12150170000	12	150-170	1,0	6,5	25
W4B12160180000	12	160-180	1,0	6,5	25
W4B12170190000	12	170-190	1,0	6,5	25
W4B12180200000	12	180-200	1,0	6,5	25

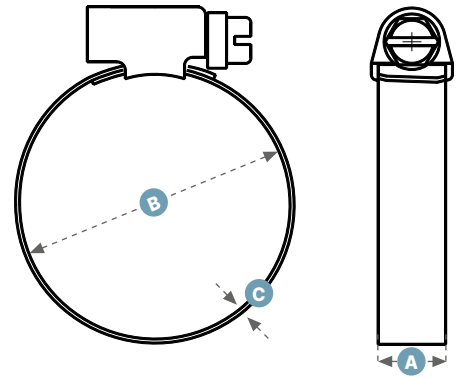

**USO APPLICATIONS**

Náutica Marine  
 Petroquímica Petrochemical  
 Alimentación Food

**DESCRIPCIÓN DESCRIPTION**

Abrazadera de alta estanqueidad, compacta y resistente. La banda interior lisa y los bordes elevados confieren a la manguera una seguridad absoluta. Conforme con la normativa DIN 3017.

High resistant clamp, compact and durable. Rolle-up band edges and smooth band underside are able to guarantee total protection to the hose. Conforme to DIN 3017.

**MATERIAL MATERIAL**

<b>Banda Band</b>	Acero inoxidable Stainless steel <b>AISI 316</b>
<b>Cajón Housing</b>	Acero inoxidable Stainless steel <b>AISI 316</b>
<b>Tornillo Screw</b>	Acero inoxidable Stainless steel <b>AISI 316</b>

		ANCH. CINTA BAND WIDTH	DIÁM. DIAM.	ESPESOR THICKNESS	PAR DE APRIETE RECOMENDADO TORQUE (PAG. 221)	CAJAS BOX
		<b>A</b> mm	<b>B</b> mm	<b>C</b> mm	<b>Nm</b>	<b>pz/nrm</b>
<b>9</b> mm	W5A09008012000	9	8-12	0,8	2,6	100
	W5A09010016000	9	10-16	0,8	2,6	100
	W5A09012020000	9	12-20	0,8	2,6	100
	W5A09016025000	9	16-25	0,8	4,0	100
	W5A09016027000	9	16-27	0,8	4,0	100
	W5A09020032000	9	20-32	0,8	4,0	100
	W5A09025040000	9	25-40	0,8	4,0	100
	W5A09035050000	9	32-50	0,8	4,0	50
	W5A09040060000	9	40-60	0,8	4,0	50
	W5A09050070000	9	50-70	0,8	4,0	50
	W5A09060080000	9	60-80	0,8	4,0	50
	W5A09070090000	9	70-90	0,8	4,0	25
	W5A09080100000	9	80-100	0,8	4,0	25
	W5A09090110000	9	90-110	0,8	4,0	25
	W5A09100120000	9	100-120	0,8	4,0	25
	W5A09011013000	9	110-130	0,8	4,0	25
W5A09012014000	9	120-140	0,8	4,0	25	
W5A09013015000	9	130-150	0,8	4,0	25	
<b>12</b> mm	W5B12012020000	12	12-20	1,0	6,5	100
	W5B12016025000	12	16-25	1,0	6,5	100
	W5B12016027000	12	16-27	1,0	6,5	100
	W5B12020032000	12	20-32	1,0	6,5	100
	W5B12025040000	12	25-40	1,0	6,5	100
	W5B12035050000	12	32-50	1,0	6,5	50
	W5B12040060000	12	40-60	1,0	6,5	50
	W5B12050070000	12	50-70	1,0	6,5	50
	W5B12060080000	12	60-80	1,0	6,5	50
	W5B12070090000	12	70-90	1,0	6,5	25
	W5B12080100000	12	80-100	1,0	6,5	25
	W5B12090110000	12	90-110	1,0	6,5	25
	W5B12100120000	12	100-120	1,0	6,5	25
	W5B12110130000	12	110-130	1,0	6,5	25
	W5B12120140000	12	120-140	1,0	6,5	25
	W5B12130150000	12	130-150	1,0	6,5	25
	W5B12140160000	12	140-160	1,0	6,5	25
	W5B12150170000	12	150-170	1,0	6,5	25
	W5B12160180000	12	160-180	1,0	6,5	25
	W5B12170190000	12	170-190	1,0	6,5	25
W5B12180200000	12	180-200	1,0	6,5	25	

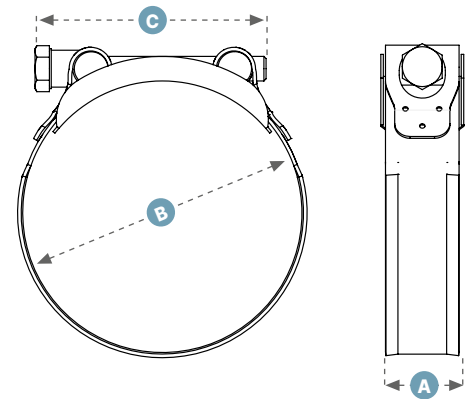

## USO APPLICATIONS

Industria en general	Industry in general
Maquinaria agrícola	Agriculture machine
Construcción	Construction
Riego	Irrigation



## DESCRIPCIÓN DESCRIPTION

Collarines de muy alto rendimiento. Especialmente indicados para mangueras de gran diámetro, muy robustos y rígidos. Los bordes elevados proporcionan a la manguera una seguridad absoluta.

High performance collars, compact and durable. Rolle-up band edges are able to guarantee total protection to the hose.



## MATERIAL MATERIAL

<b>Banda Band</b>	Acero inoxidable Stainless steel <b>AISI 430</b>
<b>Guida Guide</b>	Acero inoxidable Stainless steel <b>AISI 430</b>
<b>Tornillo Screw</b>	Acero galvanizado Zinc-plated steel

ANCH. CINTA BAND WIDTH	DIÁM. DIAM.	ESPESOR THICKNESS	PAR DE APRIETE RECOMENDADO RECOMMENDED TIGHTENING TORQUE (PAG. 221)	CAJAS BOX
<b>A</b> mm	<b>B</b> mm	<b>C</b> mm	<b>Nm</b>	<b>pz/nrm</b>

<b>21</b> mm	WC221026028000	21	26-28	M6×50	10,4	50
	WC221029031000	21	29-31	M6×50	10,4	50
	WC221032035000	21	32-35	M6X50	10,4	50
	WC221036039000	21	36-39	M6X50	10,4	50
	WC221040043000	21	40-43	M6X50	10,4	50
	WC221044047000	21	44-47	M6X50	10,4	50
	WC221048051000	21	48-51	M6X60	10,4	50
	WC221052055000	21	52-55	M6X60	10,4	50
	WC221056059000	21	56-59	M6X60	10,4	50
	WC221060063000	21	60-63	M6X60	10,4	50
WC221064067000	21	64-67	M6X55	10,4	50	

<b>24</b> mm	WC224068073000	24	68-73	M8X70	24,6	25
	WC224074079000	24	74-79	M8X70	24,6	25
	WC224080085000	24	80-85	M8X70	24,6	25
	WC224086091000	24	86-91	M8X80	24,6	25
	WC224092097000	24	92-97	M8X80	24,6	25
	WC224098103000	24	98-103	M8X80	24,6	25
	WC224104112000	24	104-112	M8X90	24,6	25
	WC224113121000	24	113-121	M8X90	24,6	25
	WC224122130000	24	122-130	M8X90	24,6	25

<b>26</b> mm	WC226131139000	26	131-139	M10X100	50,1	20
	WC226140148000	26	140-148	M10X100	50,1	20
	WC226149161000	26	149-161	M10X100	50,1	20
	WC226162174000	26	162-174	M10X100	50,1	20
	WC226175187000	26	175-187	M10X100	50,1	10
	WC226188200000	26	188-200	M10X100	50,1	10
	WC226201213000	26	201-213	M10X100	50,1	10
	WC226214226000	26	214-226	M10X100	50,1	10
	WC226227239000	26	227-239	M10X100	50,1	10
	WC226240252000	26	240-252	M10X100	50,1	10

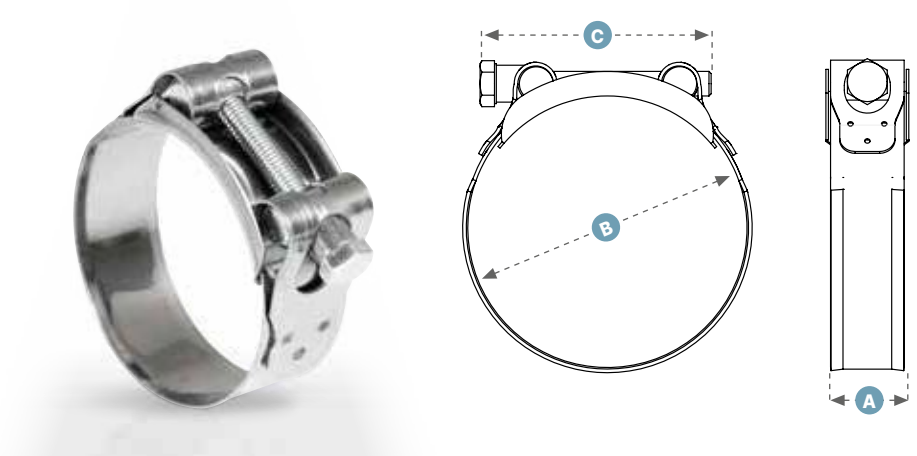

**USO APPLICATIONS**

Náutica Marine  
 Petroquímica Petrochemical  
 Alimentación Food

**DESCRIPCIÓN DESCRIPTION**

Collarines de muy alto rendimiento. Especialmente indicados para mangueras de gran diámetro, muy robustos y rígidos.

High performance collars, compact and durable. Rolle-up band edges are able to guarantee total protection to the hose.

**MATERIAL MATERIAL**

<b>Banda Band</b>	Acero inoxidable Stainless steel <b>AISI 304</b>
<b>Guida / Guide</b>	Acero inoxidable Stainless steel <b>AISI 304</b>
<b>Tornillo Screw</b>	Acero inoxidable Stainless steel <b>AISI 304</b>

ANCH. CINTA BAND WIDTH	DIÁM. DIAM.	ESPESOR THICKNESS	PAR DE APRIETE RECOMENDADO RECOMMENDED TIGHTENING TORQUE (PAG. 221)	CAJAS BOX
<b>A</b>	<b>B</b>	<b>C</b>	<b>Nm</b>	<b>pz/nrm</b>
mm	mm	mm		

<b>21</b> mm	WC421026028000	21	26-28	M6×50	5,9/10,4	50
	WC421029031000	21	29-31	M6×50	5,9/10,4	50
WC421032035000	21	32-35	M6×50	5,9/10,4	50	
WC421036039000	21	36-39	M6×50	5,9/10,4	50	
WC421040043000	21	40-43	M6×50	5,9/10,4	50	
WC421044047000	21	44-47	M6×50	5,9/10,4	50	
WC421048051000	21	48-51	M6×60	5,9/10,4	50	
WC421052055000	21	52-55	M6×60	5,9/10,4	50	
WC421056059000	21	56-59	M6×60	5,9/10,4	50	
WC421060063000	21	60-63	M6×60	5,9/10,4	50	
WC421064067000	21	64-67	M6×60	5,9/10,4	50	

<b>24</b> mm	WC424068073000	24	68-73	M8×70	14,5/25,5	25
	WC424074079000	24	74-79	M8×70	14,5/25,5	25
WC424080085000	24	80-85	M8×70	14,5/25,5	25	
WC424086091000	24	86-91	M8×80	14,5/25,5	25	
WC424092097000	24	93-97	M8×80	14,5/25,5	25	
WC424098103000	24	98-103	M8×80	14,5/25,5	25	
WC424104112000	24	104-112	M8×90	14,5/25,5	25	
WC424113121000	24	113-121	M8×90	14,5/25,5	25	
WC424122130000	24	122-130	M8×90	14,5/25,5	25	

<b>26</b> mm	WC426131139000	26	131-139	M8×100	14,5/25,5	20
	WC426140148000	26	140-148	M8×100	14,5/25,5	20
WC426149161000	26	149-161	M8×100	14,5/25,5	20	
WC426162174000	26	162-174	M8×100	14,5/25,5	20	
WC426175187000	26	175-187	M8×100	14,5/25,5	10	
WC426188200000	26	188-200	M8×100	14,5/25,5	10	
WC426201213000	26	201-213	M8×100	14,5/25,5	10	
WC426214226000	26	214-226	M8×100	14,5/25,5	10	
WC426227239000	26	227-239	M8×100	14,5/25,5	10	
WC426240252000	26	240-252	M8×100	14,5/25,5	10	



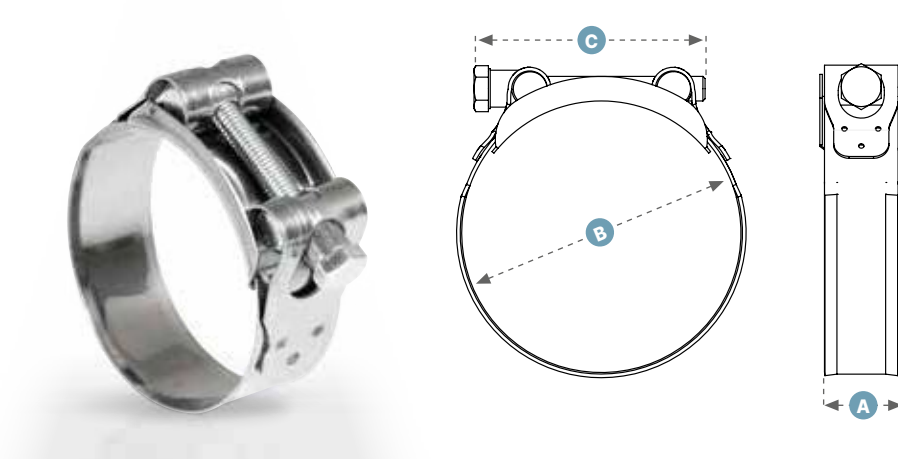

## USO APPLICATIONS

Náutica	Marine
Petroquímica	Petrochemical
Alimentación	Food



## DESCRIPCIÓN DESCRIPTION

Collarines de muy alto rendimiento. Especialmente indicados para mangueras de gran diámetro, muy robustos y rígidos. Los bordes elevados proporcionan a la manguera una seguridad absoluta.

High performance collars, compact and durable. Rolle-up band edges are able to guarantee total protection to the hose.



## MATERIAL MATERIAL

**Banda Band** Acero inoxidable  
Stainless steel  
**AISI 316**

**Guida Guide** Acero inoxidable  
Stainless steel  
**AISI 316**

**Tornillo Screw** Acero inoxidable  
Stainless steel  
**AISI 316**

ANCH. CINTA BAND WIDTH	DIÁM. DIAM.	ESPESOR THICKNESS	PAR DE APRIETE RECOMENDADO RECOMMENDED TIGHTENING TORQUE (PAG. 221)	CAJAS BOX
<b>A</b>	<b>B</b>	<b>C</b>		
mm	mm	mm	Nm	pz/nrm

### 21 mm

WC521023025000	21	23-25	M6	10	50
WC521026028000	21	26-28	M6	10	50
WC521029031000	21	29-31	M6	10	50
WC521032035000	21	32-35	M6	10	50
WC521036039000	21	36-39	M6	10	50
WC521040043000	21	40-43	M6	10	50
WC521044047000	21	44-47	M6	10	50
WC521048051000	21	48-51	M6	10	50
WC521052055000	21	52-55	M6	10	50
WC521056059000	21	56-59	M6	10	50
WC521060063000	21	60-63	M6	10	50
WC521064067000	21	64-67	M6	10	50

### 24 mm

WC524068073000	24	68-73	M8	24	25
WC524074079000	24	74-79	M8	24	25
WC524080085000	24	80-85	M8	24	25
WC524086091000	24	86-91	M8	24	25
WC524092097000	24	92-97	M8	24	25
WC524098103000	24	98-103	M8	24	25
WC524104112000	24	104-112	M8	24	25
WC524113121000	24	113-121	M8	24	25
WC524122130000	24	122-130	M8	24	25

### 26 mm

WC526131139000	26	131-139	M8	24	20
WC526140148000	26	140-148	M8	24	20
WC526149161000	26	149-161	M8	24	20
WC526162174000	26	162-174	M8	24	20
WC526175187000	26	175-187	M8	24	10
WC526188200000	26	188-200	M8	24	10
WC526201213000	26	201-213	M8	24	10
WC526214226000	26	214-226	M8	24	10
WC526227239000	26	227-239	M8	24	10
WC526240252000	26	240-252	M8	24	10

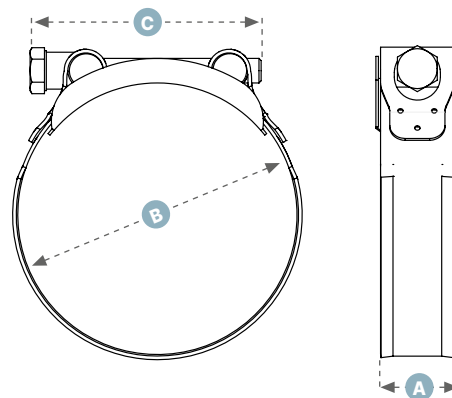

**USO APPLICATIONS**

Náutica Marine  
 Petroquímica Petrochemical  
 Alimentación Food

**DESCRIPCIÓN DESCRIPTION**

Collarines de muy alto rendimiento. Especialmente indicados para mangueras de gran diámetro, muy robustos y rígidos. Los bordes elevados proporcionan a la manguera una seguridad absoluta.

High performance collars, compact and durable. Rolle-up band edges are able to guarantee total protection to the hose.

**MATERIAL MATERIAL**

<b>Banda Band</b>	Acero inoxidable Stainless steel <b>AISI 430</b>
<b>Guida Guide</b>	Acero inoxidable Stainless steel <b>AISI 430</b>
<b>Tornillo Screw</b>	Acero inoxidable Stainless steel <b>AISI 430</b>

		ANCH. CINTA BAND WIDTH	DIÁM. DIAM.	ESPESOR THICKNESS	PAR DE APRIETE RECOMENDADO TORQUE (PAG. 221)	CAJAS BOX
		<b>A</b> mm	<b>B</b> mm	<b>C</b> mm	<b>Nm</b>	<b>pz/nrm</b>
<b>26</b> mm	WC2C26245260000	26	245-260	M10	24	1
	WC2C26250265000	26	250-265	M10	24	1
	WC2C26255270000	26	255-270	M10	24	1
	WC2C26260275000	26	260-275	M10	24	1
	WC2C26265280000	26	265-280	M10	24	1
	WC2C26270285000	26	270-285	M10	24	1
	WC2C26275290000	26	275-290	M10	24	1
	WC2C26280295000	26	280-295	M10	24	1
	WC2C26285300000	26	285-300	M10	24	1
	WC2C26290305000	26	290-305	M10	24	1
	WC2C26295310000	26	295-310	M10	24	1
	WC2C26295310000	26	300-315	M10	24	1
	WC2C26305320000	26	305-320	M10	24	1
	WC2C26310325000	26	310-325	M10	24	1
	WC2C26315330000	26	315-330	M10	24	1
	WC2C26320335000	26	320-335	M10	24	1
	WC2C26325340000	26	325-340	M10	24	1
	WC2C26335350000	26	335-350	M10	24	1
	WC2C26340355000	26	340-355	M10	24	1
	WC2C26345360000	26	345-360	M10	24	1
	WC2C26350365000	26	350-365	M10	24	1
	WC2C26360375000	26	360-375	M10	24	1
	WC2C26375390000	26	375-390	M10	24	1
	WC2C26390405000	26	390-405	M10	24	1
	WC2C26395410000	26	395-410	M10	24	1
	WC2C26400415000	26	400-415	M10	24	1
	WC2C26410425000	26	405-420	M10	24	1
	WC2C26410425000	26	410-425	M10	24	1
	WC2C26415430000	26	415-430	M10	24	1
	WC2C26425440000	26	425-440	M10	24	1
WC2C26430445000	26	430-445	M10	24	1	
WC2C26435450000	26	435-450	M10	24	1	
WC2C26440455000	26	440-455	M10	24	1	
WC2C26450465000	26	450-465	M10	24	1	
WC2C26465480000	26	465-480	M10	24	1	
WC2C26490505000	26	490-505	M10	24	1	
WC2C26500515000	26	500-515	M10	24	1	
WC2C26510525000	26	510-525	M10	24	1	
WC2C26515530000	26	515-530	M10	24	1	
WC2C26520535000	26	520-535	M10	24	1	
WC2C26535550000	26	535-550	M10	24	1	
WC2C26550565000	26	550-565	M10	24	1	
WC2C26590605000	26	590-605	M10	24	1	
WC2C26600615000	26	600-615	M10	24	1	
WC2C26610625000	26	610-625	M10	24	1	
WC2C26695710000	26	695-710	M10	24	1	
WC2C26700715000	26	700-715	M10	24	1	
WC2C26790805000	26	790-805	M10	24	1	

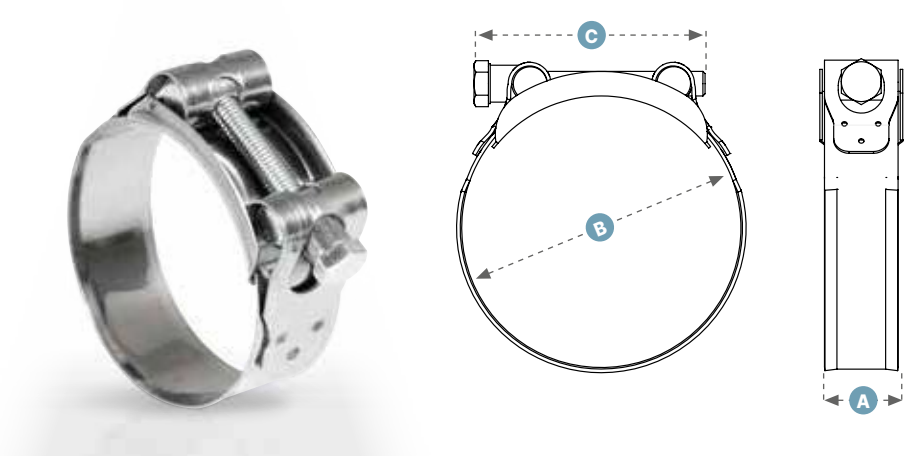

**USO APPLICATIONS**

Náutica Marine  
Alimentación Food

**DESCRIPCIÓN DESCRIPTION**

Collarines de muy alto rendimiento. Especialmente indicados para mangueras de gran diámetro, muy robustos y rígidos. Los bordes elevados proporcionan a la manguera una seguridad absoluta.

High performance collars, compact and durable. Rolle-up band edges are able to guarantee total protection to the hose.

**MATERIAL MATERIAL**

<b>Banda Band</b>	Acero inoxidable Stainless steel <b>AISI 304</b>
<b>Guida Guide</b>	Acero inoxidable Stainless steel <b>AISI 304</b>
<b>Tornillo Screw</b>	Acero inoxidable Stainless steel <b>AISI 304</b>

	ANCH. CINTA BAND WIDTH	DIÁM. DIAM.	ESPESOR THICKNESS	PAR DE APRIETE RECOMENDADO RECOMMENDED TIGHTENING TORQUE (PAG. 221)	CAJAS BOX	
						<b>A</b> mm
<b>26</b> mm	WC4C26245260000	26	245-260	M8	24	1
	WC4C26250265000	26	250-265	M8	24	1
	WC4C26255270000	26	255-270	M8	24	1
	WC4C26260275000	26	260-275	M8	24	1
	WC4C26265280000	26	265-280	M8	24	1
	WC4C26270285000	26	270-285	M8	24	1
	WC4C26275290000	26	275-290	M8	24	1
	WC4C26280295000	26	280-295	M8	24	1
	WC4C26285300000	26	285-300	M8	24	1
	WC4C26290305000	26	290-305	M8	24	1
	WC4C26295310000	26	295-310	M8	24	1
	WC4C26295310000	26	300-315	M8	24	1
	WC4C26305320000	26	305-320	M8	24	1
	WC4C26310325000	26	310-325	M8	24	1
	WC4C26315330000	26	315-330	M8	24	1
	WC4C26320335000	26	320-335	M8	24	1
	WC4C26325340000	26	325-340	M8	24	1
	WC4C26335350000	26	335-350	M8	24	1
	WC4C26340355000	26	340-355	M8	24	1
	WC4C26345360000	26	345-360	M8	24	1
	WC4C26350365000	26	350-365	M8	24	1
	WC4C26360375000	26	360-375	M8	24	1
	WC4C26375390000	26	375-390	M8	24	1
	WC4C26390405000	26	390-405	M8	24	1
	WC4C26395410000	26	395-410	M8	24	1
	WC4C26400415000	26	400-415	M8	24	1
	WC4C26410425000	26	405-420	M8	24	1
	WC4C26410425000	26	410-425	M8	24	1
WC4C26415430000	26	415-430	M8	24	1	
WC4C26425440000	26	425-440	M8	24	1	
WC4C26430445000	26	430-445	M8	24	1	
WC4C26435450000	26	435-450	M8	24	1	
WC4C26440455000	26	440-455	M8	24	1	
WC4C26450465000	26	450-465	M8	24	1	
WC4C26465480000	26	465-480	M8	24	1	
WC4C26490505000	26	490-505	M8	24	1	
WC4C26500515000	26	500-515	M8	24	1	
WC4C26510525000	26	510-525	M8	24	1	
WC4C26515530000	26	515-530	M8	24	1	
WC4C26520535000	26	520-535	M8	24	1	
WC4C26535550000	26	535-550	M8	24	1	
WC4C26550565000	26	550-565	M8	24	1	
WC4C26590605000	26	590-605	M8	24	1	
WC4C26600615000	26	600-615	M8	24	1	
WC4C26610625000	26	610-625	M8	24	1	
WC4C26695710000	26	695-710	M8	24	1	
WC4C26700715000	26	700-715	M8	24	1	
WC4C26790805000	26	790-805	M8	24	1	

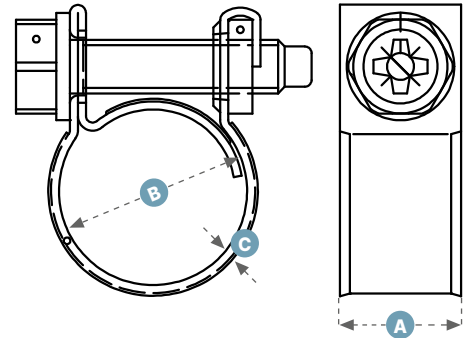

## USO APPLICATIONS

Industria en general	Industry in general
Maquinaria agrícola	Agriculture machine
Ciclomotores	Motorcycles
Automoción	Automotive

## DESCRIPCIÓN DESCRIPTION

El mini collarín de gasolina tiene una banda con bordes elevados para no dañar la manguera. La lengüeta inferior está reforzada. Otro detalle práctico es la cabeza hexagonal del tornillo, dentada y apta para el uso de un destornillador flexible. Es especialmente adecuado para mangueras finas y de pequeño diámetro.

This clamp features rolled-up band edges that are gentle on hoses. The band tongue that fits under the hose is profiled for added strength.

## MATERIAL MATERIAL

<b>Banda Band</b>	Acero galvanizado Zinc-plated steel
<b>Chiave Bolt</b>	<b>7 mm</b>
<b>Tornillo Screw</b>	Acero galvanizado Zinc-plated steel <b>AISI 430</b>

	ANCH. CINTA BAND WIDTH	DIÁM. DIAM.	ESPESOR THICKNESS	PAR DE APRIETE RECOMENDADO TORQUE (PAG. 221)	CAJAS BOX	
	<b>A</b> mm	<b>B</b> mm	<b>C</b> mm	<b>Nm</b>	<b>pz/nrm</b>	
<b>9 mm</b>	WCM007009	9	7-9	0,6	1,2	2000
	WCM009010	9	9-10	0,6	1,2	2000
	WCM100000	9	8,5-11	0,6	1,2	2000
	WCM110000	9	9,5-12	0,6	1,2	2000
	WCM120000	9	11-13	0,6	1,2	3000
	WCM130000	9	11,5-14	0,6	1,2	3000
	WCM140000	9	13-15	0,6	1,2	3000
	WCM150000	9	14-16	0,6	1,2	3000
	WCM160000	9	15-17	0,6	1,2	3000
	WCM170000	9	16-18	0,6	1,2	2500
	WCM180000	9	17-19	0,6	1,2	2500
	WCM190000	9	18-21	0,6	1,2	2500
	WCM200000	9	19-21	0,6	1,2	2500
	WCM290000	9	24-29	0,6	1,2	1200



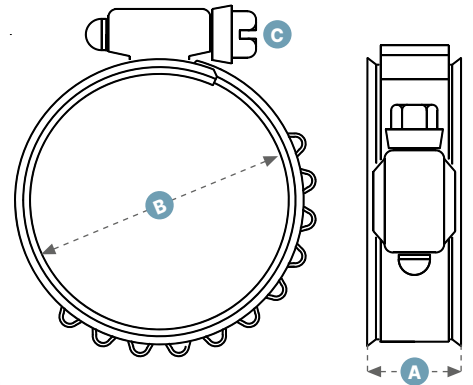

### USO APPLICATIONS

Industria en general	Industry in general
Maquinaria agrícola	Agriculture machine
Construcción	Construction
Náutica	Marine
Militar	Military
Automoción	Automotive



### DESCRIPCIÓN DESCRIPTION

Las abrazaderas con anillo interior SAE tipo T WTS tienen un sellado perfecto en aplicaciones en manguitos sujetos a dilatación térmica y relajación de la manguera. Su construcción especial garantiza una tensión constante gracias al efecto combinado del anillo interior y la banda contorneada. El acabado electropulido de la superficie proporciona una mayor resistencia a la corrosión.

With a convoluted heat-treated band that provides spring-like tensioning effects for thermal cycling hose applications. This clamp concentrates band-sealing pressure, increasing performance up to 30% compared to standard smooth liners. Flanged edges protect soft hose compounds from abrasion and wear.



### MATERIAL MATERIAL

<b>Banda</b> Band	Acero inoxidable Stainless steel <b>AISI 304</b>
<b>Cajón</b> Housing	Acero inoxidable Stainless steel <b>SERIES 300</b>
<b>Tornillo</b> Screw	Acero inoxidable Stainless steel <b>SERIES 300</b>

ANCH. CINTA BAND WIDTH	DIÁM. DIAM.	ESPESOR THICKNESS	PAR DE APRIETE RECOMENDADO RECOMMENDED TIGHTENING TORQUE (PAG. 221)	CAJAS BOX
<b>A</b> mm	<b>B</b> mm	<b>C</b> mm	<b>Nm</b>	<b>pz/nrm</b>

**16  
mm**

WTS028038	16,51	28-38	8	5,6	400
WTS030041	16,51	30-41	8	5,6	400
WTS035048	16,51	35-48	8	5,6	400
WTS040054	16,51	40-54	8	5,6	300
WTS041060	16,51	41-60	8	5,6	300
WTS046067	16,51	46-67	8	5,6	200
WTS050073	16,51	50-73	8	5,6	200
WTS057079	16,51	57-79	8	5,6	200
WTS064086	16,51	64-86	8	5,6	200
WTS070092	16,51	70-92	8	5,6	200
WTS076098	16,51	76-98	8	5,6	200
WTS083105	16,51	83-105	8	5,6	200
WTS089111	16,51	89-111	8	5,6	200
WTS095118	16,51	95-118	8	5,6	200
WTS108130	16,51	108-130	8	5,6	200
WTS121143	16,51	121-143	8	5,6	100
WTS146148	16,51	146-168	8	5,6	100
WTS159181	16,51	159-181	8	5,6	100
WTS184206	16,51	184-206	8	5,6	100

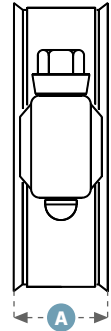
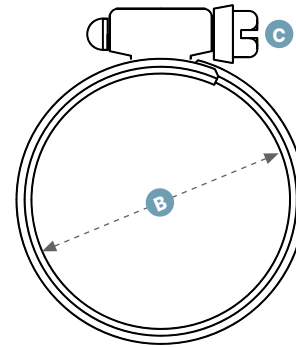

### USO APPLICATIONS

Industria en general	Industry in general
Maquinaria agrícola	Agriculture machine
Construcción	Construction
Ciclomotores	Motorcycles
Automoción	Automotive



### DESCRIPCIÓN DESCRIPTION

Las abrazaderas con anillo interior SAE tipo F WDB son especialmente adecuadas para circuitos de refrigeración. El anillo interior proporciona un sellado seguro en mangueras fabricadas con materiales blandos al crear un efecto de junta tórica entre la abrazadera, la manguera y el portamangueras.

For air to air and coolant applications. The inner shield provides superb sealing characteristics and is safe for all soft hoses. It can also be found in the marine, agriculture, construction and off-highway markets.

ANCH. CINTA BAND WIDTH	DIÁM. DIAM.	ESPESOR THICKNESS	PAR DE APRIETE RECOMENDADO TORQUE (PAG. 221)	CAJAS BOX
<b>A</b>	<b>B</b>	<b>C</b>	<b>Nm</b>	<b>pz/nrm</b>
<b>mm</b>	<b>mm</b>	<b>mm</b>		

# 16 mm

WDB015034	16,51	15,9-34,9	8	3,4-4,5	400
WDB017041	16,51	17,5-41,4	8	3,4-4,5	400
WDB023047	16,51	23,8-47,6	8	3,4-4,5	400
WDB030054	16,51	30,2-54,0	8	3,4-4,5	400
WDB036060	16,51	36,5-60,3	8	3,4-4,5	300
WDB042066	16,51	42,9-66,7	8	3,4-4,5	300
WDB049073	16,51	49,2-73,0	8	3,4-4,5	300
WDB055079	16,51	55,6-79,4	8	3,4-4,5	300
WDB061085	16,51	61,9-85,7	8	3,4-4,5	300
WDB068092	16,51	68,3-92,1	8	3,4-4,5	300
WDB074098	16,51	74,6-98,4	8	3,4-4,5	200
WDB087111	16,51	87,3-111,1	8	3,4-4,5	200
WDB100123	16,51	100,0-123,8	8	3,4-4,5	200
WDB112136	16,51	112,7-136,5	8	3,4-4,5	200



### MATERIAL MATERIAL

<b>Banda</b> Band	Acero inoxidable Stainless steel <b>AISI 304</b>
<b>Cajón</b> Housing	Acero inoxidable Stainless steel <b>SERIES 300</b>
<b>Tornillo</b> Screw	Acero inoxidable Stainless steel <b>SERIES 300</b>

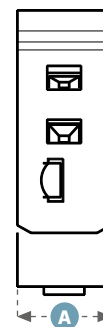
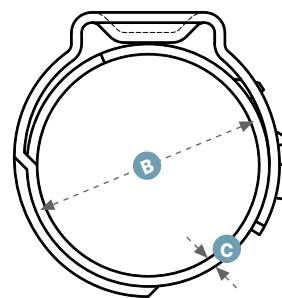

## USO APPLICATIONS

Náutica	Marine
Petroquímica	Petrochemical
Ciclomotores	Motorcycles
Automoción	Automotive
Alimentación	Food
Bebida	Beverage



## DESCRIPCIÓN DESCRIPTION

Las abrazaderas pinzables antitorsión WGT ofrecen facilidad y rapidez de montaje y, gracias a su construcción, permiten un contacto de 360° con la manguera, eliminando posibles puntos de fuga. La abrazadera está fabricada en acero inoxidable AISI 304. Ideal para aplicaciones en líneas de petróleo, bebidas, medicina e industria en general.

These clamps offer 360° seamless fastening. Due to their seamless design and uniform compression sealing, these clamps are often used in the beverage, automotive, marine, and motorcycle industries. They are manufactured using 304 Stainless Steel and are perfect for poly and braided tubing.



## MATERIAL MATERIAL

<b>Banda Band</b>	Acero inoxidable Stainless steel <b>AISI 304</b>
-------------------	--

ANCH. CINTA BAND WIDTH	DIÁM. DIAM.	ESPESOR THICKNESS	CAJAS BOX
<b>A</b>	<b>B</b>	<b>C</b>	
mm	mm	mm	pz/nrm

**5  
mm**

WGT05070	5	5,8-7,0	0,48	2500
WGT05080	5	6,8-8,0	0,48	2500
WGT05087	5	7,0-8,7	0,48	2500
WGT05090	5	7,3-9,0	0,48	2500
WGT05095	5	7,8-9,5	0,48	2500
WGT05100	5	8,3-10,0	0,48	2500
WGT05105	5	8,8-10,5	0,48	2500
WGT05109	5	9,2-10,9	0,48	2500
WGT05113	5	9,6-11,3	0,48	2500
WGT05118	5	10,1-11,8	0,48	2500

**7  
mm**

WGT07123	7	9,8-12,3	0,56	2500
WGT07128	7	10,3-12,8	0,56	2500
WGT07133	7	10,8-13,3	0,56	2500
WGT07138	7	11,3-13,8	0,56	2500
WGT07140	7	11,5-14,0	0,56	2500
WGT07145	7	12,0-14,5	0,56	2500
WGT07148	7	12,3-14,8	0,56	2500
WGT07153	7	12,8-15,3	0,56	2500
WGT07127	7	13,2-15,7	0,56	2500
WGT07162	7	13,7-16,2	0,56	2500
WGT07164	7	13,9-16,4	0,56	2500
WGT07170	7	14,5-17,0	0,56	2500
WGT07180	7	15,5-18,0	0,56	2500
WGT07185	7	16,0-18,5	0,56	2500
WGT07192	7	16,0-19,2	0,56	A PETICIÓN ON DEMAND
WGT07198	7	16,6-19,8	0,56	A PETICIÓN ON DEMAND
WGT07210	7	17,8-21,0	0,56	A PETICIÓN ON DEMAND
WGT07226	7	19,4-22,6	0,56	A PETICIÓN ON DEMAND
WGT07235	7	20,3-23,5	0,56	A PETICIÓN ON DEMAND
WGT07241	7	20,9-24,1	0,56	A PETICIÓN ON DEMAND
WGT07256	7	22,4-25,6	0,56	A PETICIÓN ON DEMAND
WGT07271	7	23,9-27,1	0,56	A PETICIÓN ON DEMAND
WGT07286	7	25,4-28,6	0,56	A PETICIÓN ON DEMAND
WGT07301	7	26,9-30,1	0,56	A PETICIÓN ON DEMAND
WGT07308	7	27,6-30,8	0,56	A PETICIÓN ON DEMAND
WGT07316	7	28,4-31,6	0,56	A PETICIÓN ON DEMAND
WGT07331	7	29,9-33,1	0,56	A PETICIÓN ON DEMAND
WGT07346	7	31,4-34,6	0,56	A PETICIÓN ON DEMAND
WGT07361	7	32,9-36,1	0,56	A PETICIÓN ON DEMAND
WGT07376	7	34,4-37,6	0,56	A PETICIÓN ON DEMAND
WGT07381	7	34,9-38,1	0,56	A PETICIÓN ON DEMAND
WGT07396	7	36,4-39,6	0,56	A PETICIÓN ON DEMAND
WGT07410	7	37,8-41,0	0,56	A PETICIÓN ON DEMAND
WGT07455	7	42,3-45,5	0,56	A PETICIÓN ON DEMAND

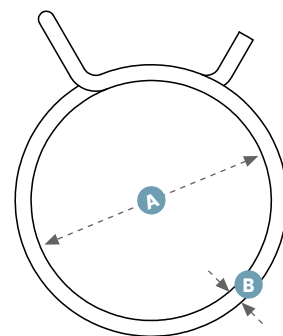

## USO APPLICATIONS

Industria en general	Industry in general
Ciclomotores	Motorcycles
Automoción	Automotive



## DESCRIPCIÓN DESCRIPTION

Abrazaderas fabricadas con alambre de acero galvanizado doble; la elasticidad del material permite compensar pequeñas variaciones diametrales. Ideal en mangueras muy finas y para un sellado no severo. Se recomienda utilizar racores con suficiente alivio para contrarrestar la carga de la abrazadera y evitar que la manguera se salga.

Clamps made in double zinc-plated steel wire. Recommended on hoses of very thin thickness and forlight-duty works.



## MATERIAL MATERIAL

Banda Band	Filo acciaio zincato Wire zinc-plated steel
------------	---

	DIAM. DIAM.	Ø ALAMBRE Ø WIRE	CAJAS BOX	CAJAS BOX	CAJAS BOX
	A	B			
	mm	mm	pz/nrm	pz/nrm	pz/nrm
WBS056007	6,6-7	1,0	25000	8300	2500
WBS070075	7-7,5	1,0	20000	8300	2000
WBS073078	7,3-7,8	1,0	20000	8300	2000
WBS078083	7,8-8,3	1,0	20000	8300	2000
WBS083088	8,3-8,8	1,0	12000	6600	1200
WBS088093	8,8-9,3	1,0	15000	5000	1500
WBS093098	9,3-9,8	1,0	15000	5000	1500
WBS098104	9,8-10,4	1,2	10000	3300	1000
WBS104110	10,4-11	1,2	10000	3300	1000
WBS110116	11-11,6	1,2	9000	3300	900
WBS116122	11,6-12,2	1,5	6000	2000	600
WBS122129	12,2-12,9	1,5	5000	2000	500
WBS124131	12,4-13,10	1,2	7000	2000	700
WBS129136	12,9-13,6	1,5	4500	2000	400
WBS133141	13,3-14,1	1,5	4000	1300	400
WBS136144	13,6-14,4	1,5	4000	1300	400
WBS144151	14,4-15,10	1,8	3000	1300	300
WBS148159	14,8-15,9	1,6	3500	1300	300
WBS151159	15,10-15,9	1,8	3000	1000	300
WBS154162	15,4-16,2	1,8	3000	1000	300
WBS159168	15,9-16,8	1,8	3000	1000	300
WBS168177	16,8-17,7	1,8	3000	1000	300
WBS177187	17,7-18,7	1,9	2200	700	200
WBS187195	18,7-19,5	2,0	2000	700	200
WBS196205	19,6-20,5	2,0	1500	700	200
WBS206216	20,6-21,6	2,0	1500	700	200
WBS215226	21,5-22,6	2,2	1300	500	100
WBS220231	22,0-23,1	2,2	1300	500	100
WBS224236	22,4-23,6	2,2	1200	400	100
WBS235247	23,5-24,7	2,2	1200	400	100
WBS245258	24,5-25,8	2,5	1000	300	100
WBS251264	25,1-26,4	2,5	900	300	100
WBS256269	25,6-26,9	2,5	800	300	100
WBS267281	26,7-28,1	2,5	750	250	100
WBS279294	27,9-29,4	2,5	750	250	100
WBS293309	29,3-30,9	2,8	750	200	100
WBS304320	30,4-32	2,8	500	200	100
WBS318334	31,8-33,4	2,8	500	200	100
WBS332348	33,2-34,8	2,8	450	200	100
WBS339357	33,9-35,7	2,8	500	200	100
WBS346364	34,6-36,4	3,0	450	200	100
WBS362380	36,2-38	3,0	450	200	100
WBS377397	37,7-39,7	3,2	400	200	100
WBS385405	38,5-40,5	3,2	400	200	100
WBS389408	38,9-40,8	3,2	350	-	-
WBS394414	39,4-41,4	3,2	350	-	-
WBS407423	40,7-42,3	3,2	350	-	-
WBS410432	41-43,2	3,2	300	-	-
WBS428450	42,8-45	3,2	300	-	-
WBS446468	44,6-46,8	3,2	300	-	-
WBS465489	46,5-48,9	3,2	300	-	-
WBS488509	48,8-50,9	3,5	200	-	-
WBS506532	50,6-53,2	3,5	200	-	-
WBS527554	52,7-55,4	3,5	200	-	-
WBS560588	56-58,8	3,5	150	-	-
WBS582610	58,2-61	3,5	150	-	-



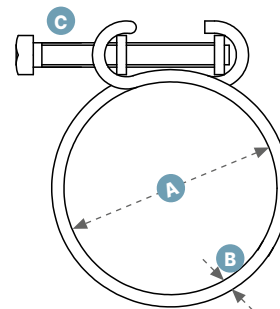

## USO APPLICATIONS

Industria en general / Industry in general  
Automoción / Automotive



## DESCRIPCIÓN DESCRIPTION

Abrazaderas recomendadas para sujetar mangueras con espirales en relieve. Están fabricadas con doble alambre de acero galvanizado y garantizan una sujeción óptima incluso con mangueras muy blandas y finas.

Recommended for hoses with spirals in relief. The clamps are made with a double zinc-plated steel wire and they grant an optimal clamping also on soft and thin hoses.



## MATERIAL MATERIAL

Banda / Band: Acero galvanizado / Zinc-plated steel

ANCH. CINTA  
BAND WIDTH

DIÁM.  
DIAM.

ESPESOR  
THICKNESS

CAJAS  
BOX

	A mm	B mm	C mm	pz/nrm
WBV012000	9,5-12	1,5	M3	2500
WBV013000	10,5-13	1,5	M3	2500
WBV014000	11,5-14	1,5	M3	2500
WBV015000	12,5-15	1,5	M3	2500
WBV016000	13-16	1,8	M3	3000
WBV017000	13,5-17	1,8	M3	3000
WBV018000	15-18	1,8	M3	3000
WBV019000	15,5-19	1,8	M3	2500
WBV020000	17-20	1,8	M3	2500
WBV021000	17,5-21	1,8	M3	2000
WBV022000	18,5-22	2,0	M4	1500
WBV023000	19-23	2,0	M4	1500
WBV025000	21,5-25	2,0	M4	1500
WBV027000	23,5-27	2,2	M4	1500
WBV029000	25-29	2,2	M4	1000
WBV031000	27-31	2,2	M4	1000
WBV033000	29-33	2,2	M4	1000
WBV035000	30,5-35	2,2	M4	1000
WBV037000	33-37	2,2	M4	1000
WBV040000	35,5-40	2,2	M4	800
WBV043000	38,5-43	2,2	M4	800
WBV046000	41-46	2,5	M5	500
WBV049000	43,5-49	2,5	M5	500
WBV053000	46,5-53	2,5	M5	400
WBV056000	50,5-56	2,5	M5	400
WBV060000	53,5-60	2,5	M6	400
WBV064000	56,5-64	2,8	M6	A PETICIÓN ON DEMAND
WBV068000	60-68	2,8	M6	A PETICIÓN ON DEMAND
WBV072000	64-72	2,8	M6	A PETICIÓN ON DEMAND
WBV076000	68,5-76	2,8	M6	A PETICIÓN ON DEMAND
WBV080000	72,5-80	3,0	M6	A PETICIÓN ON DEMAND
WBV084000	76,5-84	3,0	M6	A PETICIÓN ON DEMAND
WBV088000	80-88	3,0	M6	A PETICIÓN ON DEMAND
WBV096000	88-96	3,0	M6	A PETICIÓN ON DEMAND
WBV100000	92-100	3,0	M6	A PETICIÓN ON DEMAND
WBV104000	95-104	3,0	M6	A PETICIÓN ON DEMAND
WBV108000	98-108	3,0	M6	A PETICIÓN ON DEMAND
WBV112000	103-112	3,0	M6	A PETICIÓN ON DEMAND
WBV116000	109-116	3,0	M6	A PETICIÓN ON DEMAND
WBV120000	111-120	3,0	M6	A PETICIÓN ON DEMAND
WBV124000	115-124	3,0	M6	A PETICIÓN ON DEMAND
WBV128000	120-128	3,0	M6	A PETICIÓN ON DEMAND
WBV132000	124-132	3,0	M6	A PETICIÓN ON DEMAND
WBV140000	125-140	3,0	M6	A PETICIÓN ON DEMAND
WBV150000	134-150	3,0	M6	A PETICIÓN ON DEMAND
WBV160000	145-160	3,0	M6	A PETICIÓN ON DEMAND
WBV165000	150-165	3,0	M6	A PETICIÓN ON DEMAND
WBV170000	155-170	3,0	M6	A PETICIÓN ON DEMAND
WBV180000	165-180	3,0	M6	A PETICIÓN ON DEMAND
WBV190000	175-190	3,0	M6	A PETICIÓN ON DEMAND

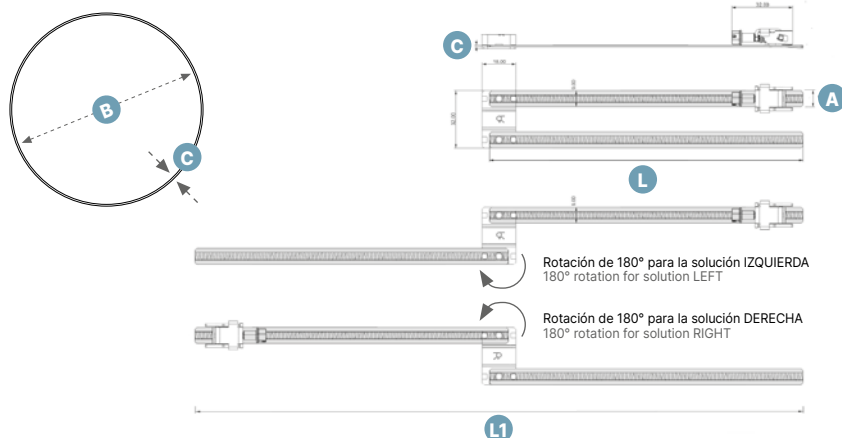
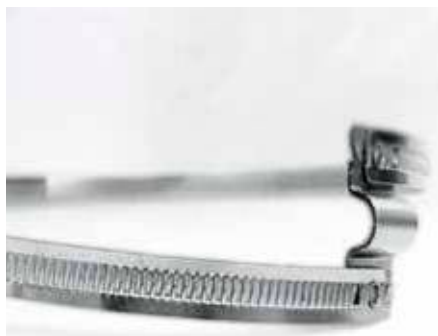

## USO APPLICATIONS

Industria en general	Industry in general
Maquinaria agrícola	Agriculture machine
Construcción	Construction
Alimentación	Food

## DESCRIPCIÓN DESCRIPTION

Una revolucionaria abrazadera para sujetar mangueras en espiral, la abrazadera SSS, gracias a su nuevo sistema patentado, puede utilizarse tanto para mangueras con espiral derechas como izquierdas. Girando el pasador central del puente de una de las dos bandas, el operador puede obtener la abrazadera que se utilizará en una manguera con espiral derecha o izquierda. Además, la banda moletada a lo largo de toda la abrazadera permite cubrir una amplia gama de diámetros, lo que disminuye drásticamente la gestión de los códigos de pieza de stock. Por último, la ausencia de soldaduras garantiza un excelente rendimiento de sujeción.

Revolutionary hose clamp for the tightening of the spiral pipe, thanks to the new system patented it can be used for both the right and left spiral tubes. With the rotation operation on the central pin of the bridge by one of the two bands, the operator can obtain the band to be used on the tube with right or left spiral, moreover, the knurled band on the whole length of the band allows to cover a wide range of diameters drastically reducing the management of the codes to warehouse. Finally the absence of welding guarantees an excellent performance of Tightening torque (pag. 221).

## MATERIAL MATERIAL

Banda Band	Acero inoxidable Stainless steel <b>AISI 430</b>
Cajón Housing	Acero inoxidable Stainless steel <b>AISI 430</b>
Tornillo Screw	Acero galvanizado Zinc-plated steel

	ANCH. CINTA BAND WIDTH	DIÁM. DIAM.	ESPESOR THICKNESS	LONGITUD DE LA ABRAZADERA CERRADA-ABIERTA LENGHT CLOSED LENGHT OPEN	PAR DE APRIETE RECOMENDADO RECOMMENDED TIGHTENING TORQUE (PAG. 221)	CAJAS BOX
	A mm	B mm	C mm	L - L1 mm	Nm	pz/nrm
WSS06013500000	9,0	60 - 135	0,6	211 - 425	3,5	25
WSS10017500000	9,0	100-175	0,6	274 - 550	3,5	25
WSS12522500000	9,0	125-225	0,6	355 - 710	3,5	25
WSS15828500000	9,0	158 - 285	0,6	450 - 900	3,5	25
WSS17531500000	9,0	175 - 315	0,6	500 - 1000	3,5	25
WSS19535000000	9,0	195 - 350	0,6	550 - 1100	3,5	25
WSS21338500000	9,0	213 - 385	0,6	610 - 1220	3,5	25
WSS24043500000	9,0	240 - 435	0,6	700 - 1400	3,5	25
WSS27048500000	9,0	270 - 485	0,6	775 - 1550	3,5	25
WSS29553500000	9,0	295 - 535	0,6	850 - 1700	3,5	25

## CARACTERÍSTICAS FÍSICAS Y MECÁNICAS PHYSICAL AND MECHANICAL PROPERTIES

	W2
ESTRUCTURA Structure	Ferrit.
CARGA DE ROTURA Breaking Load Rp 0,2 (N/mm <sup>2</sup> ) min	280
Rm (N/mm <sup>2</sup> ) min.	450-600
MÓDULO DE ELASTICIDAD A 20°C Elasticity in tensions at 20°C (kN/mm <sup>2</sup> )	220
ALARGAMIENTO Elongation (min)	20
COEFICIENTE DE DILATACIÓN TÉRMICA Coefficient of thermal expansions 20 ÷ 200°C	10
CONDUCTIVIDAD TÉRMICA A 20°C Thermal conductivity at 20°C (W/m x K)	25
RESISTENCIA A LA CORROSIÓN Corrosion resistance	PREN* 16.00 - 18.00

## INFORMACIÓN TÉCNICA TECHNICAL INFORMATION

TEMPERATURA DE EJERCICIO Working temp.	-80°C to 538°C
INFLAMABILIDAD Flammability	Ignífugo Fireproof
PROPIEDADES ELECTROMAGNÉTICAS Electromagnetic prop.	Magnético Magnetic
OTRAS Others	Resistente a los rayos UV UV resistant

## TABLA DE MATERIALES SEGÚN LA NORMA DIN 3017 Y PRINCIPALES NORMAS INTERNACIONALES TABLE OF MATERIALS ACCORDING TO DIN 3017 AND MAIN INTERNATIONAL STANDARDS

MATERIAL Material	ITALY UNI	DE WNDIN	UK B.S	FRANCE AFNOR	USA AISI-SAE
RESISTENCIA A LA NIEBLA SALINA Hour corrosion in salt spray (min.h)					72 H

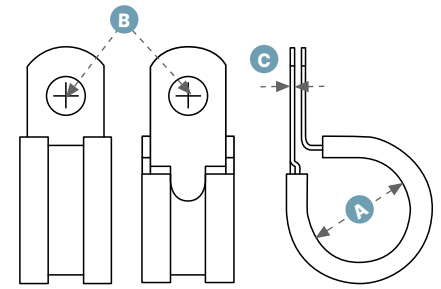

**USO  
APPLICATIONS**

Industria en general	Industry in general
Maquinaria agrícola	Agriculture machine
Náutica	Marine
Automoción	Automotive



**DESCRIPCIÓN  
DESCRIPTION**

Fabricados en acero galvanizado perfilado y recubierto de material antivibratorio, para asegurar y garantizar una protección óptima de los cables/mangueras contenidos en los propios pasacables y la absorción de las posibles vibraciones. Banda reforzada en el orificio de fijación. Conforme con la normativa DIN 3016.

Reinforcement band and strip in shaped galvanized steel coated with anti-vibration rubber to ensure optimal protection of the cables/ pipes contained in the cable glands with the absorption of any vibrations. Manufactured according to DIN3016.



**MATERIAL  
MATERIAL**

<b>Banda Band</b>	Acero galvanizado Zinc-plated steel
<b>Revestimiento Coating</b>	Caucho EPDM EPDM rubber

DIAM. DIAM.	ORIFICIO DE FIJACIÓN HOLE DIAM.	ESPESOR DE LA BANDA BAND THICKNESS	CAJAS BOX
<b>A</b>	<b>B</b>	<b>C</b>	<b>pz/nrm</b>
mm	mm	mm	

**15  
mm**

WCGC115006	6	6,4	0,6	100
WCGC115008	8	6,4	0,6	100
WCGC115010	10	6,4	0,6	100
WCGC115012	12	6,4	0,6	100
WCGC115014	14	6,4	0,6	100
WCGC115015	15	6,4	0,8	100
WCGC115016	16	6,4	0,8	100
WCGC115018	18	6,4	0,8	100
WCGC115020	20	6,4	0,8	100
WCGC115022	22	6,4	0,8	100
WCGC115024	24	6,4	0,8	100
WCGC115025	25	6,4	0,8	100
WCGC115028	28	6,4	0,8	100
WCGC115030	30	6,4	0,8	100
WCGC115032	32	6,4	0,8	100
WCGC115035	35	6,4	0,8	100
WCGC115038	38	6,4	0,8	100
WCGC115040	40	6,4	0,8	100

**20  
mm**

WCGC120010	10	8,4	0,8	50
WCGC120011	11	8,4	0,8	50
WCGC120012	12	8,4	0,8	50
WCGC120013	13	8,4	0,8	50
WCGC120014	14	8,4	0,8	50
WCGC120015	15	8,4	0,8	50
WCGC120016	16	8,4	0,8	50
WCGC120017	17	8,4	0,8	50
WCGC120018	18	8,4	0,8	50
WCGC120020	20	8,4	0,8	50
WCGC120022	22	8,4	0,8	50
WCGC120024	24	8,4	0,8	50
WCGC120025	25	8,4	0,8	50
WCGC120026	26	8,4	1,0	50
WCGC120028	28	8,4	1,0	50
WCGC120030	30	8,4	1,0	50
WCGC120032	32	8,4	1,0	50
WCGC120034	34	8,4	1,0	50
WCGC120035	35	8,4	1,0	50
WCGC120036	36	8,4	1,0	50
WCGC120038	38	8,4	1,0	50
WCGC120040	40	8,4	1,0	50
WCGC120042	42	8,4	1,0	50
WCGC120044	44	8,4	1,0	50
WCGC120046	46	8,4	1,0	50
WCGC120048	48	8,4	1,0	50
WCGC120050	50	8,4	1,0	50
WCGC120052	52	8,4	1,0	50
WCGC120054	54	8,4	1,0	50
WCGC120056	56	8,4	1,0	50
WCGC120058	58	8,4	1,0	50
WCGC120060	60	8,4	1,0	50
WCGC120062	62	8,4	1,0	50

## SNA

CINTAS BANDI-BLOCK  
BANDS BANDI-BLOCK

De acero austenítico, en rollos de 30 y 50 m embaladas en cajas de cartón.  
Austenitic stainless steel Bands in 30 and 50 m rolls, packed in stout cardboard box.



Industria en general Industry in general  
Riego Irrigation  
Náutica Marine  
Petroquímica Petrochemical

MATERIAL MATERIAL	CÓDIGO CODE	ANCHURA WIDTH ↔	ESPESOR THICKNESS ▲	CARGA MEDIA DE ROTURA AVERAGE BREAKING STRENGTH ▼	CAJAS BOX 📦	PESO WEIGHT KG
		mm	mm	kg	mt/cad	kg/cad
Acero inox Stainless steel AISI 201	WNA095201	9,50	0,65	410	30	1,5
	WNA127201	12,70	0,75	680	30	2,3
	WNA158201	15,80	0,75	850	30	2,9
	WNA195201	19,05	0,75	1020	30	3,5
Acero inox Stainless steel AISI 304	WNA095304	9,50	0,65	390	30	1,5
	WNA127304	12,70	0,75	500	30	2,3
	WNA158304	15,80	0,75	650	30	2,9
	WNA195304	19,05	0,75	950	30	3,5
Acero inox Stainless steel AISI 316	WNA095316	9,50	0,65	340	30	1,5
	WNA127316	12,70	0,75	540	30	2,3
	WNA158316	15,80	0,75	680	30	2,9
	WNA195316	19,05	0,75	820	30	3,5

## SNG

GRAPAS BANDI-BLOCK  
BUCKLES BANDI-BLOCK

De acero inoxidable austenítico, embaladas en cajas de cartón de 100 unidades.  
Austenitic stainless steel Buckles, packed in cardboard box of 100 pieces.



MATERIAL MATERIAL	CÓDIGO CODE	ANCHURA WIDTH ↔	PARA CINTAS FOR BAND	CARGA MEDIA DE ROTURA AVERAGE BREAKING STRENGTH ▼	CAJAS BOX 📦	PESO WEIGHT KG
		mm		kg	mt/cad	kg/cad
Acero inox Stainless steel AISI 304	WNG095304	9,50	AISI 201	390	100	0,5
	WNG127304	12,70	AISI 201	500	100	1,0
	WNG158304	15,80	AISI 201	650	100	1,3
	WNG195304	19,05	AISI 201	950	100	1,6
Acero inox Stainless steel AISI 316	WNG095316	9,50	AISI 316	340	100	0,5
	WNG127316	12,70	AISI 316	540	100	1,0
	WNG158316	15,80	AISI 316	680	100	1,3
	WNG195316	19,05	AISI 316	820	100	1,6

## SNU

HERRAMIENTA MANUAL  
TOOL BANDI-BLOCK

Esta herramienta permite realizar la instalación completa, es decir, fijar con tensión y cortar la parte sobrante de la cinta.

The tool allows for the full installation, that is fixing by pulling and cutting band exceeding part.



CÓDIGO CODE	PARA CINTAS FOR BAND	CAJAS BOX 📦	PESO WEIGHT KG
		pz/cad	kg/cad
WNU001	AISI 201 AISI 304 AISI 316	1	2,0



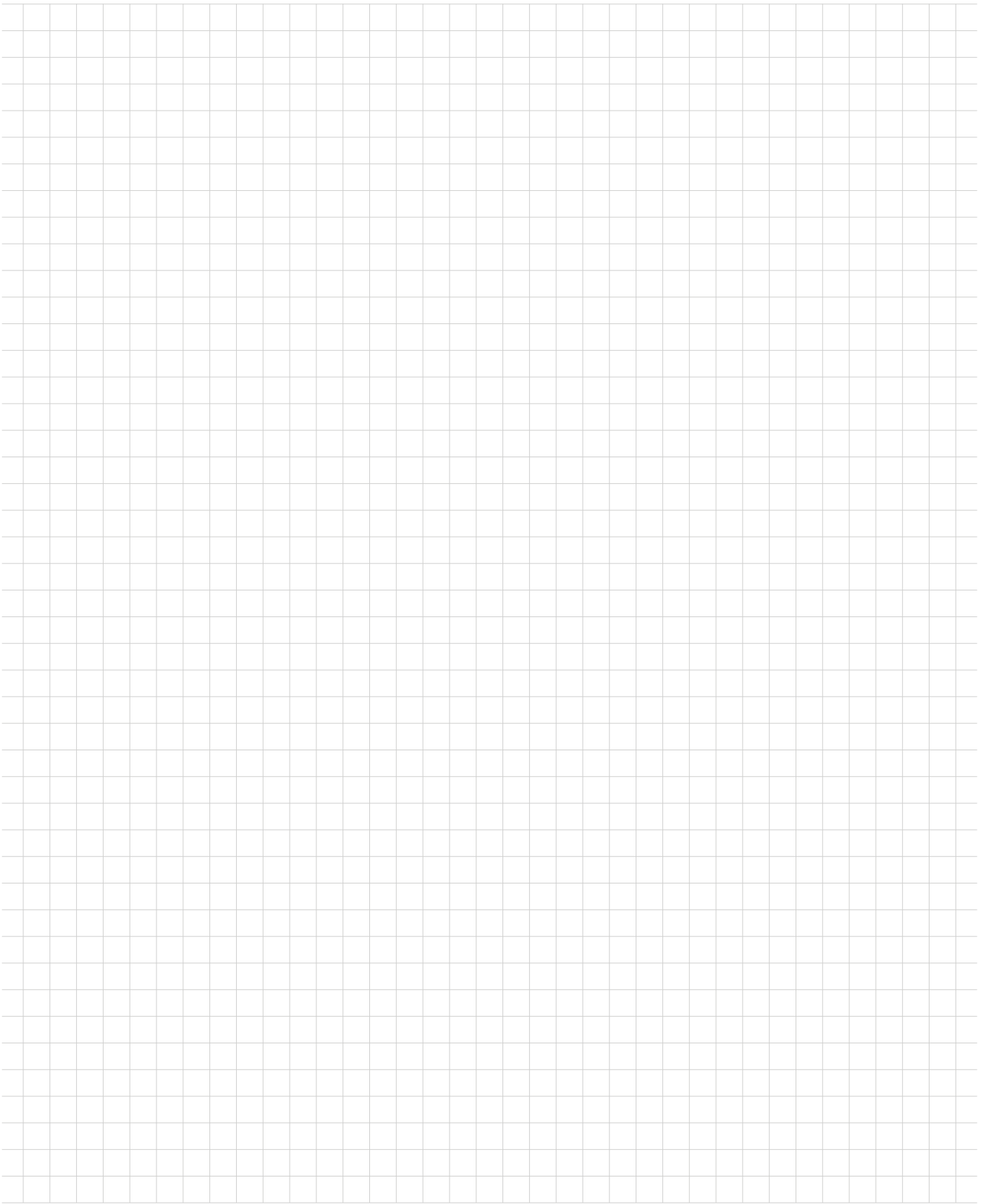

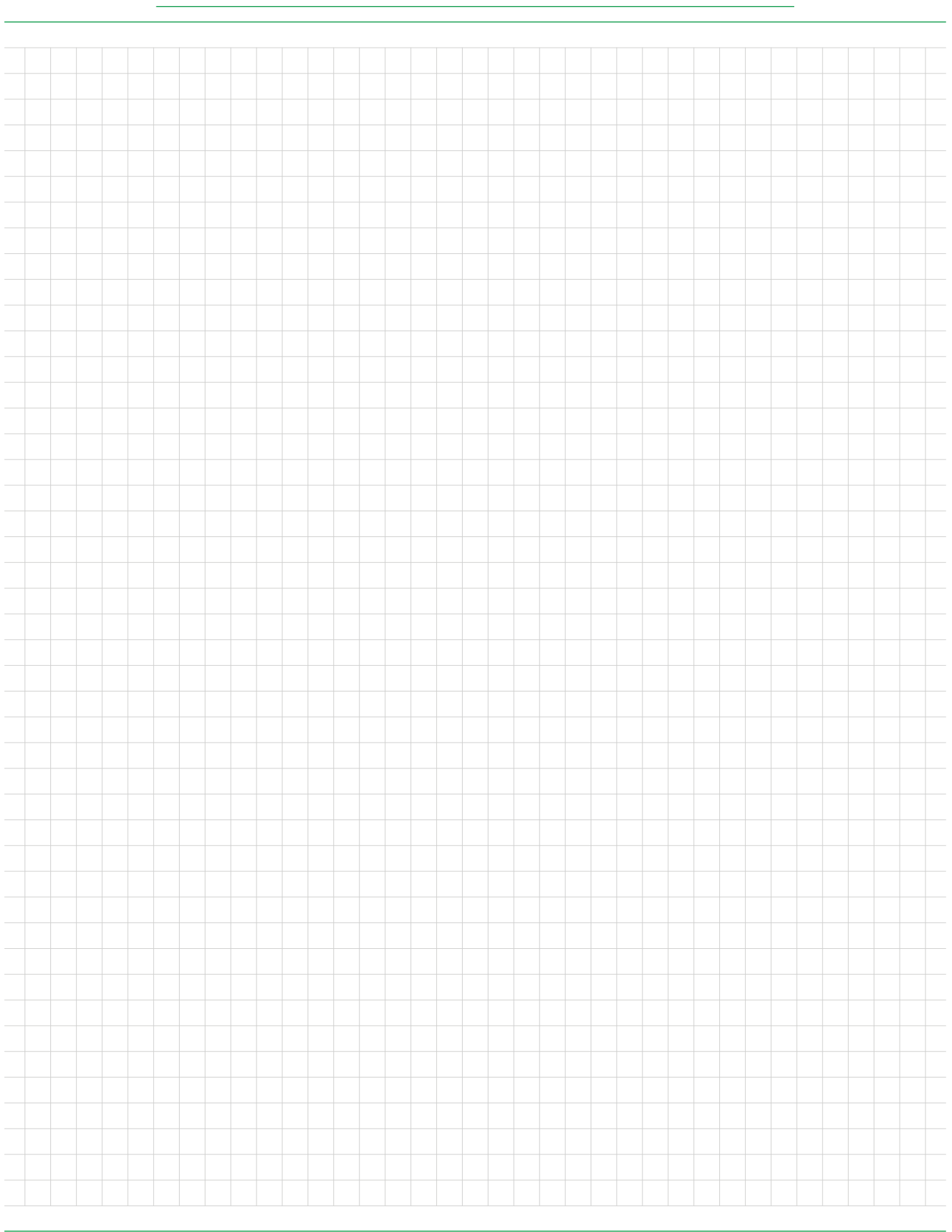



### BELTS DIVISION

RUBBER CONVEYOR BELTS



 **SATIBELT**

 **SATIVERTICAL**

### SHEETS DIVISION

RUBBER SHEETS AND FOAM



 **SATISHEET**

 **SATIFOAM**

### HOSES DIVISION

RUBBER AND PVC HOSES



 **SATIHOSE**

 **SATIHOSE**

**MARINE**  
 **SATIBLOCK**



- **TODA LA GAMA DE PRODUCTOS**  
FULL PRODUCT RANGE
- **FICHAS TÉCNICAS**  
TECHNICAL DATA SHEETS
- **SOLUCIONES POR SECTOR**  
SECTORS SOLUTIONS
- **NOVEDAD**  
NEWS

VISIT OUR WEBSITE

**[www.satigroup.it](http://www.satigroup.it)**







**SATI GROUP S.P.A.**

Via Bonazzi, 24  
40013 Castel Maggiore  
Bologna - Italy  
T +39 051 700321  
[www.satigroup.it](http://www.satigroup.it)

Ufficio vendite italia  
[commerciale@satigroup.it](mailto:commerciale@satigroup.it)  
Ufficio vendite estero  
[export@satigroup.it](mailto:export@satigroup.it)

P. IVA 00672251204